

# TWO4SIX®

## Planning Guide + Price List

---

### QUICK LINKS

[PLANNING GUIDE](#)

[MEETING TABLES](#)

[MEDIA TABLES](#)

[STANDING HEIGHT  
MEETING TABLES](#)

[HEIGHT ADJUSTABLE  
MEETING TABLES](#)

[POWER AND DATA OPTIONS](#)

[GENERAL INFORMATION](#)

[FINISH INFORMATION](#)

[SURFACE MATERIALS](#)



# TABLE OF CONTENTS

Click the shortcuts below to jump to each section.

General Information	ii-iii
Finish Information	iv-v
Surface Materials	vi-viii

Statement of Line	3
Specification Overview	4

## MEETING TABLES

Round / Square / Soft Square Tops	47-53
Rectangle / Soft Rectangle Tops	54-71

## MEDIA TABLES

60" Credenza Base	72-77
72" Credenza Base	78-83
Wall-Mounted - Slab Base	84-101

## STANDING HEIGHT MEETING TABLES

Rectangle / Soft Rectangle Tops	102-119
---------------------------------	---------

HEIGHT ADJUSTABLE MEETING TABLES	120
----------------------------------	-----

POWER AND DATA OPTIONS	121-131
------------------------	---------

CONSOLE	132
---------	-----

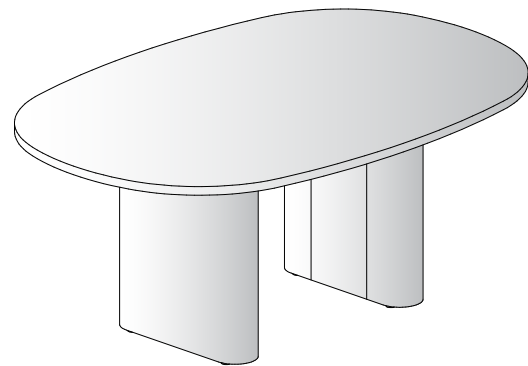
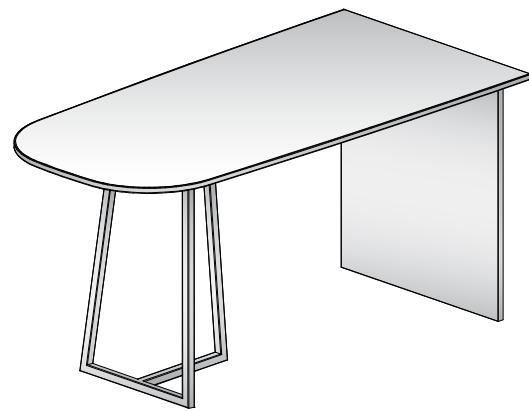
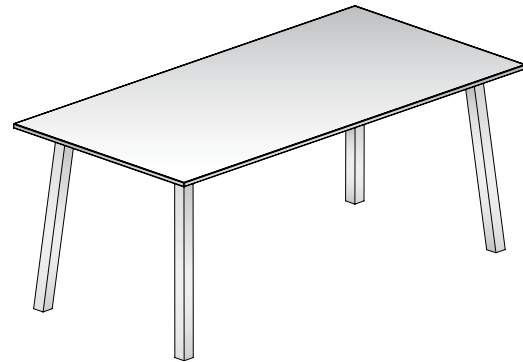



# STATEMENT OF LINE

## MEETING TABLES

Pages 47-71



Round



Square

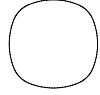

Soft Square



Rectangle

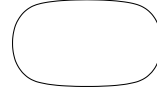

Soft Rectangle

## RECTANGLE AND SOFT RECTANGLE BASES

Pages 54-71

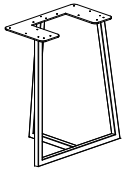

Open Frame

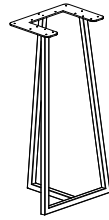

Open Frame Standing



Post Leg

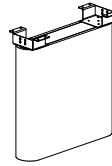

Racetrack Base

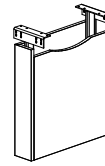

Rectangle Center Base

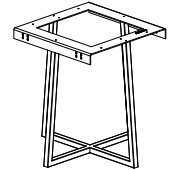

X Center Base

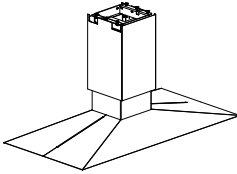

Adjustable Height Base

## ROUND, SQUARE AND SOFT SQUARE BASES

Page 47-53

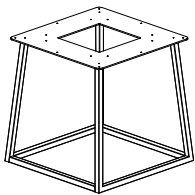

Open Frame Square



Post Leg

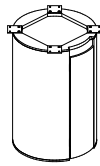

Cylinder Base



# STATEMENT OF LINE

## MEDIA TABLES

---

Pages 72-101



D-Shape

## WALL-MOUNTED BASES

---

Pages 72-101

### FLAT END OF TABLE

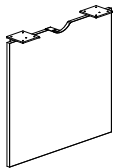

Slab

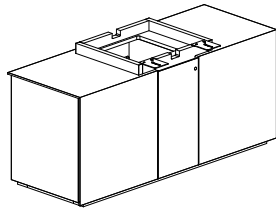

Credenza

### RADIUS END OF TABLE

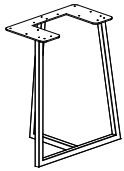

Open Frame Seated

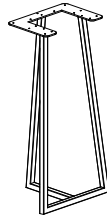

Open Frame Standing



Post Leg

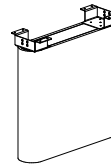

Racetrack Base

## CONSOLE

---

Page 132

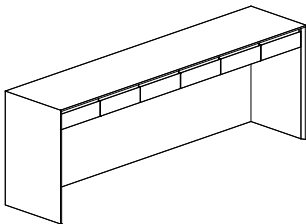



# SPECIFICATION OVERVIEW

---

## 1. Select the Table Type

Options include Meeting Tables, Standing Height Meeting Tables, Height Adjustable Meeting Tables, and Wall-mounted Media Tables.

## 2. Select the Top Surface Material

Choose between standard veneer with hardwood edge, inset laminate with hardwood edge, laminate with cutback ABS edge, laminate with square ABS edge, glass, solid surface or stone/quartz.

## 3. Select the Top Size and Shape

Two4Six tables are available in round, square, soft square, rectangle, soft rectangle, and D-shape. Sizes range from 30"- to 72"-wide and from 48"- to 240"-long.

## 4. Select the Base Style and Finish

Two4Six tables are available with Metal Post Legs, Open Frame, and Racetrack base styles, as well as a Height Adjustable base option. Metal Post Leg and Open Frame bases are offered with powder coated paint or polished chrome finishes. In addition, the Metal Post Leg is available with a clear anodized finish. The Racetrack base is offered in laminate, painted, or veneer. Media Tables include a Slab base (available in both painted and veneered surfaces) or a Credenza base (available in veneer only). Height adjustable Racetrack base also offered on Media Table.

## 5. Select the Power/AV Option (if desired)

Options for power and AV connectivity include:

- Table Top: Tech Node, Power Cap or Power Matrix (Small or Medium)
- Sub-Top: Power Rail



# MEETING TABLES

Meeting tables are offered in round, square, soft square, rectangle and soft rectangle shapes at a seated height (29.5"). A standing height (42") option is also available for rectangle and soft rectangle tables. Meeting table base options include 2"-square Metal Post Legs, an Open Frame base (made from 1.25" square metal tube), Racetrack base, and Cylinder base (for round tables only).

BASE MATERIAL OPTIONS						
	VENEER	PAINTED	LAMINATE	POWDER COAT	POLISHED CHROME	CLEAR ANODIZED
Racetrack	X	X	X			
2" Post Metal Leg				X	X	X
Open Frame				X	X	
Adjustable Height (Meeting Table)				X		

TABLES 156" & LONGER						
Rectangle Center	X	X				
X Center				X	X	

MEDIA TABLES ONLY						
Wall-mounted Slab	X	X				
Credenza	X					
Rectangle Base	X	X	X			

ROUND TABLES ONLY						
Cylinder	X	X				

TOP MATERIAL OPTIONS					
	VENEER	LAMINATE (ALL EDGES)	GLASS	SOLID SURFACE	STONE
Round, Square & Soft Square	X	X	X	X	X
Rectangle & Soft Rectangle	X	X	X	X	
D-Shape	X	X	X	X	

**Soft Rectangle Meeting Table with Open Frame Base**

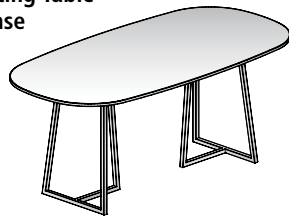

**Rectangle Meeting Table with Metal Post Legs and Rectangle Center Base**

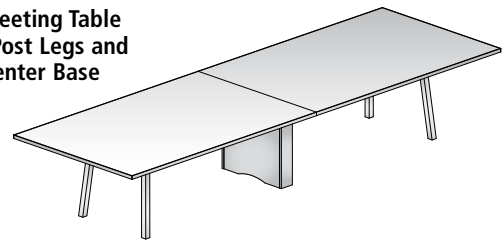

**Rectangle Meeting Table with Metal Post Legs**

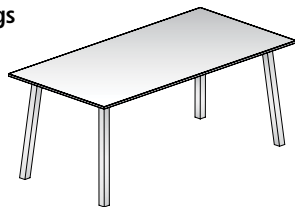

**Rectangle Meeting Table with Open Frame Base and X Center Base**

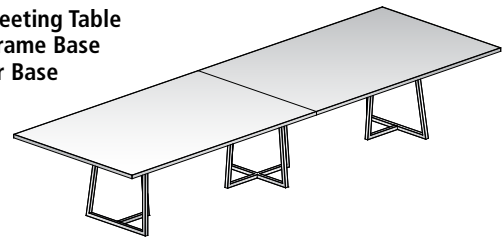

**Soft Rectangle Meeting Table with Racetrack Base**

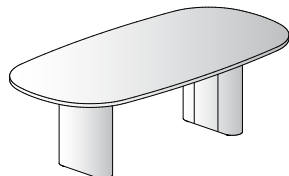

**Rectangle Meeting Table with Racetrack Base**

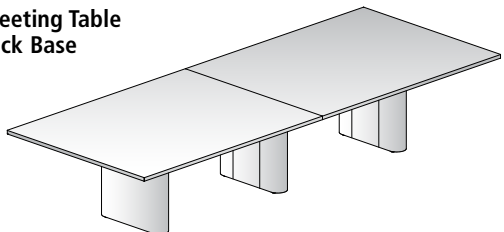



## WALL-MOUNTED MEDIA TABLES

There are two options for Media Tables: wall-mounted and freestanding. Both styles are available with a variety of base options.

Wall-mounted media tables are available in seated, counter and standing heights and require an architectural wall on which to be mounted.

The flat end of the table offers a Slab base available in seated, counter and standing heights. Credenza base is available in seated height and has two case sizes, 60" and 72". In addition, credenza base offers optional pullout waste/recycle bins, equipment rack available on 72", and video conferencing shelf.

On the radius end of the table, options include, 2"- square Metal Post Legs available in seated height, Open Frame base available in seated, counter and standing height or a Racetrack base available in seated and standing heights.

Wall mounted media tables offer optional Monitor Panel. Please see pricing section for more detail.

Please see finish matrix for finishing information on page 6.

**D-Shape Wall-mounted Media Table with Open Frame Base and Slab Base**

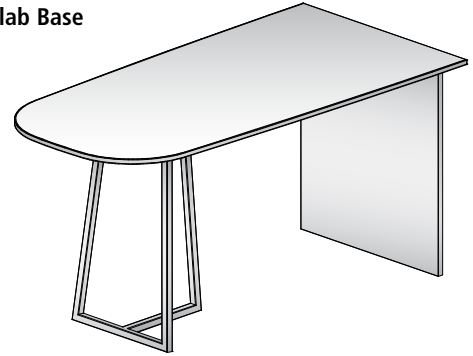

**D-Shape Wall-mounted Media Table with Racetrack Base and Slab Base**

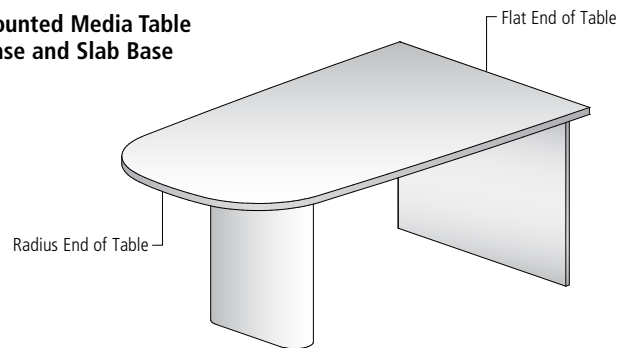

**D-Shape Media Table with Credenza Base**

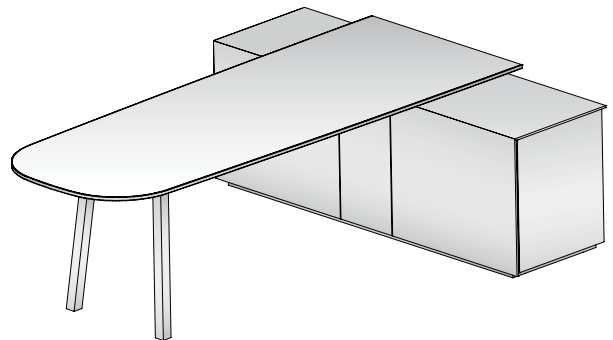

**Optional Pull-Out Waste/Recycle Bins**

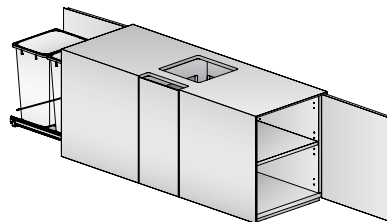

**Optional Pull-Out Equipment Rack**

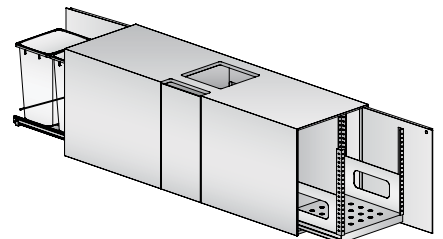



# ADJUSTABLE HEIGHT TABLE

The adjustable height table promotes wellness and can be used to imply meeting duration or encourage impromptu collaboration. Offering a height adjustment range from 28" to 42".

## ADJUSTABLE HEIGHT TABLE

This rectangular desk features a metal column base.

- Adjustment range is from 28" to 42"
- Controller features digital height readout and four programmable stops
- Features a metal column base
- Available with Power Rail

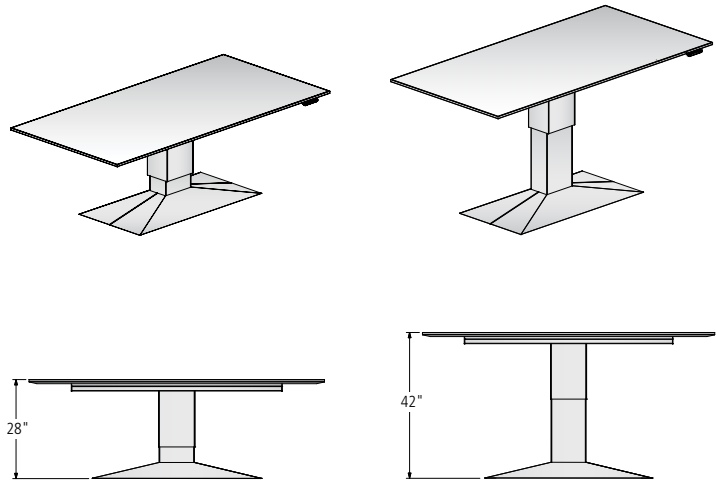

## Wire Management for Adjustable Height Table

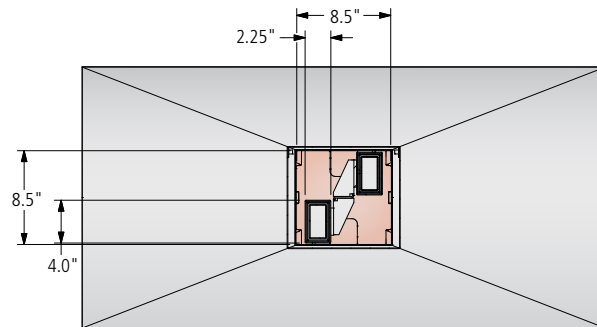

## PROGRAMMABLE CONTROLLER

The programmable controller features up/down buttons, four programmable preset stops, and a digital readout that displays the worksurface height.

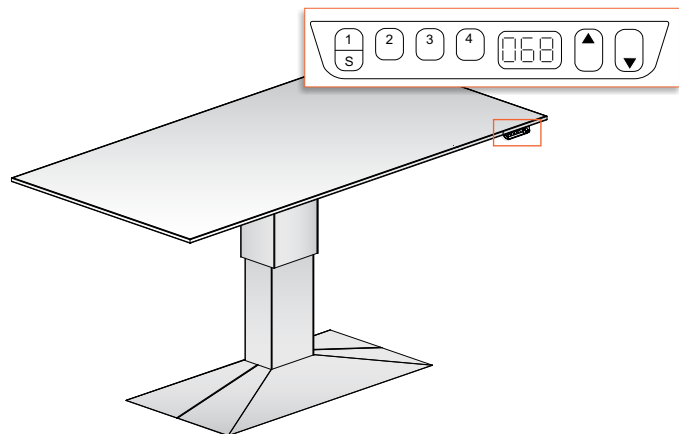





## TABLE TOP POWER OPTION: POWER MATRIX

Available in a variety of sizes, styles and connectivity options, Power Matrix is Nucraft's most versatile power option. Power Matrix incorporates a broad array of scalable features and is available across multiple product lines, making it the "go to" solution for power and AV connectivity needs.

Offered in a Small and Medium size, Power Matrix can handle any power and AV connectivity need, from the simplest to the most demanding.

### Small

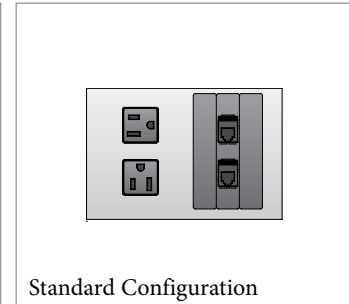
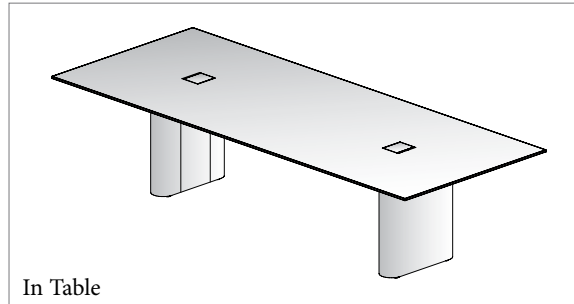

### Medium

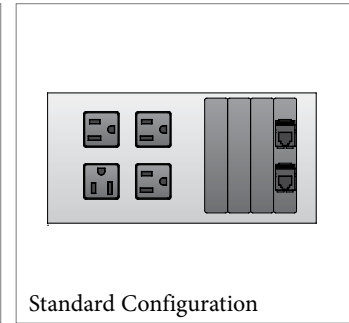
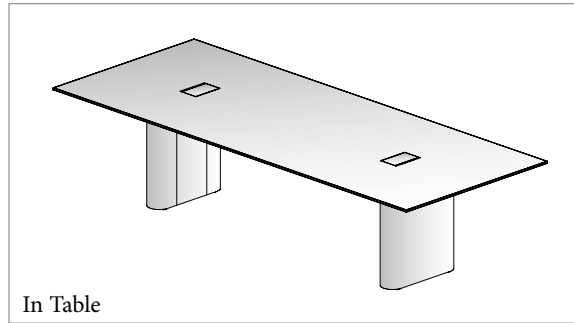
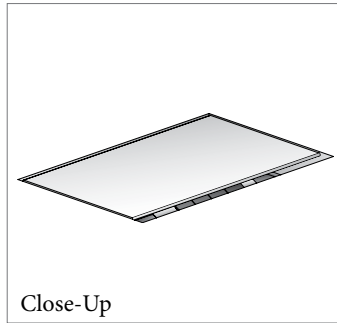

## TABLE TOP POWER OPTION: POWER MATRIX

Power Matrix is filled with a broad array of high performance features and refined aesthetic elements.

### POWER

Power Matrix features simplex receptacles for power connectivity, the quantity of which is pre-determined based on the size of the unit. An optional USB-A+C charger can also be specified in place of one of the simplex receptacles when desired. Corded or hardwired infeed options add flexibility.

### DATA/AV FACEPLATES

Power Matrix accommodates Extron Architectural Adaptor Plates (AAPs) for unparalleled flexibility in data and AV connectivity.

### DESIGN

Power Matrix units feature a clear anodized aluminum body and a bezel-free flush mount design on wood tables for an elegant appearance. Laminate, glass or stone/quartz table tops include a bezel, available in powder coat, polished chrome or clear anodized finish options.

### PERFORMANCE

Friction hinges ensure smooth travel through the door's range of motion and can hold the door in any position. Hidden door stops maintain the minimalist aesthetic. Cable storage is both concealed and ample.

### DOORS

Power Matrix is offered in multiple door material options, including metal, glass and grain-matched wood cut from the same table top.

### FIELD-WIRED

Some local electrical codes may require field-wiring during installation. In such instances, a Field-Wired option may be specified. In this configuration, each Power Matrix unit will be supplied with a 6' flexible metal conduit with hot, ground and neutral wires.

(Medium size shown)

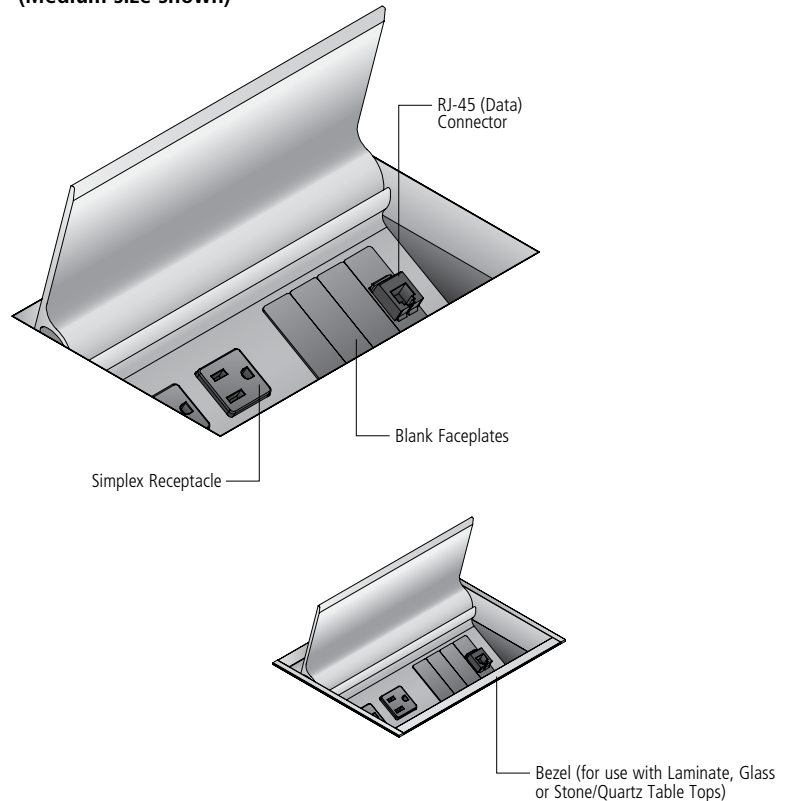



# TABLE TOP POWER OPTION: POWER MATRIX

## STANDARD CONFIGURATIONS

Power Matrix is available in two sizes for Two4Six, each with a pre-determined quantity of simplex outlets and AV faceplates. With each size, an optional 2 amp USB-A+C charger (1 amp per port) replaces one of the simplex outlets.

### Small

- Single door design
- 5.375" x 6" cutout
- Two simplex outlets
- Three AV faceplates. Standard configuration includes two blank faceplates & one faceplate with two RJ-45 (data) connectors.

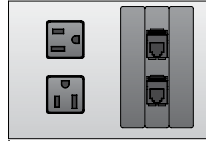

### Medium

- Single door design
- 5.375" x 8.25" cutout
- Four simplex outlets
- Four AV faceplates. Standard configuration includes three blank faceplates & one faceplate with two RJ-45 (data) connectors.

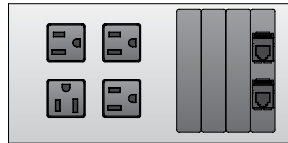

## DIMENSIONS

Each Power Matrix unit includes a low-profile pan beneath the work surface to conceal the unit and provide ample storage capacity for excess cables. The size of the cutout in the table top varies with each size of Power Matrix unit.

### Small

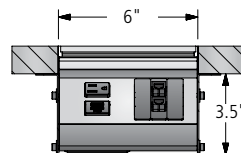
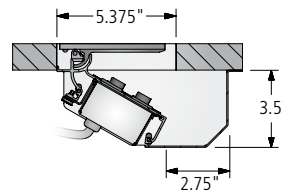

### Medium

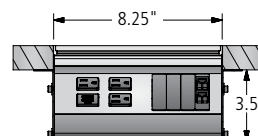
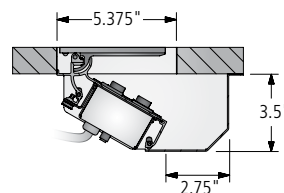

# TABLE TOP POWER OPTION: POWER MATRIX

## POWER PLANNING

Power Matrix is available with two options for connection with building power:

### DIRECT PLUG-IN

The 15-amp power cord from each Power Matrix unit is plugged into a floor monument. The floor monument must have at least one power outlet per small or medium Power Matrix unit in the table (e.g., a table with four small or medium Power Matrix units would need four power outlets in the floor monument).

**Direct Plug-In**

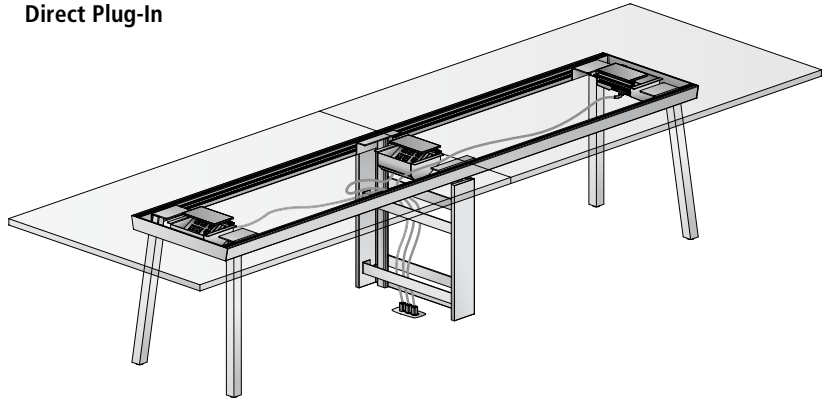

### SINGLE INFEED

Each Power Matrix unit is plugged into a two-circuit modular electrical system in the table from which a single connection is made to a floor monument. This connection can be either hardwired (to utilize both of the circuits in the modular electrical system) or corded (which requires a 20-amp power outlet in the floor monument and reduces the modular electrical system in the table to a single circuit).

**Single Infeed**

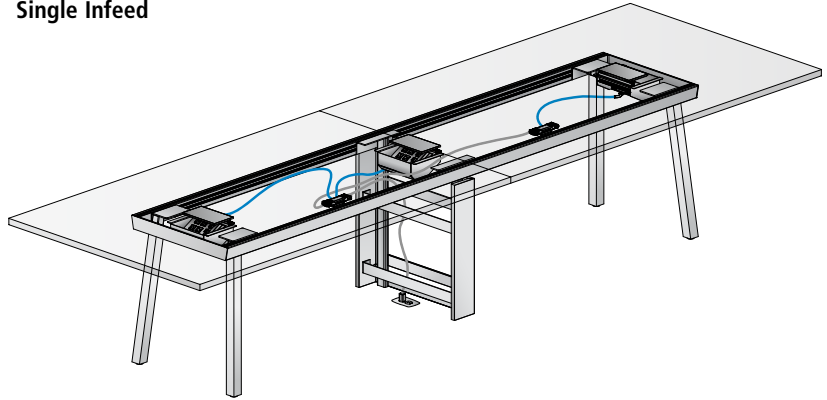

### Two-Circuit Modular Electrical System

- 4-wire, 20-amp, 2-circuit modular electrical system
- Only present on tables specified with the Single In-Feed option
- Hardwire or corded (20-amp) in-feed options. A licensed electrician is required to complete hardwire connections to building's power source.
- Neutral (white) wires are 10 gauge, hot and ground wires are 12 gauge
- All electrical components satisfy National Electrical Code (NEC) requirements and are UL listed

### Electrical Diagram — Hardwire Power Infeed Only

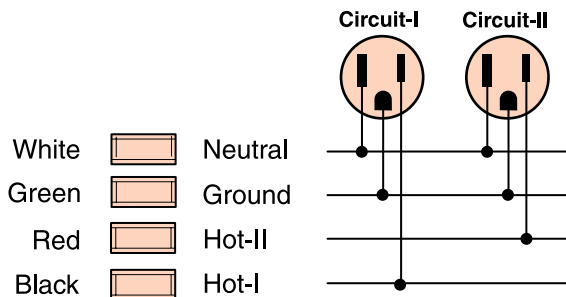



# TABLE TOP POWER OPTION: POWER MATRIX

## LOCATION CODES

Power Matrix is offered in a variety of locations and quantities per table size, offering a broad range of performance and pricing options.

POWER MATRIX SMALL	POWER MATRIX MEDIUM	LOCATION	QUANTITY OF UNITS TO ORDER
PS-1	PM-1	One at center	1
PS-1W	PM-1W	One at wall end (Media Table only)	1
PS-2*	PM-2*	One at each end	2
PS-3*	PM-3*	One at center and one at each end	3
PS-4*	PM-4*	Four equally spaced	4

\*Not offered on Media Tables, Standing Height Tables, or Counter Height Tables

## DOOR MATERIAL AND LOCATION AVAILABILITY BY TABLE SIZE

W = Wood Door    G = Glass Door    M = Metal Door

Length	Top Sections	Power Matrix Small					Power Matrix Medium				
		PS-1	PS-1W†	PS-2*	PS-3*	PS-4*	PM-1	PM-1W†	PM-2*	PM-3*	PM-4*
48	1	W/G/M	-	-	-	-	-	-	-	-	-
54	1	W/G/M	-	-	-	-	-	-	-	-	-
60	1	W/G/M	W/G/M	-	-	-	-	W/G/M	-	-	-
66	1	W/G/M	W/G/M	-	-	-	W/G/M	W/G/M	-	-	-
72	1	W/G/M	W/G/M	-	-	-	W/G/M	W/G/M	-	-	-
84	1	W/G/M	W/G/M	-	-	-	W/G/M	W/G/M	-	-	-
90	1	W/G/M	W/G/M	-	-	-	W/G/M	W/G/M	-	-	-
96	1	W/G/M	W/G/M	-	-	-	W/G/M	W/G/M	-	-	-
102	1	W/G/M	-	W/G/M	W/G/M	-	W/G/M	-	W/G/M	W/G/M	-
102	2	-	-	W/G/M	-	-	-	-	W/G/M	-	-
108	1	W/G/M	-	W/G/M	W/G/M	-	W/G/M	-	W/G/M	W/G/M	-
108	2	-	-	W/G/M	-	-	-	-	W/G/M	-	-
114	1	W/G/M	-	W/G/M	W/G/M	-	W/G/M	-	W/G/M	W/G/M	-
114	2	-	-	W/G/M	-	-	-	-	W/G/M	-	-
120	1	W/G/M	-	W/G/M	W/G/M	-	W/G/M	-	W/G/M	W/G/M	-
120	2	-	-	W/G/M	-	-	-	-	W/G/M	-	-
132	2	-	-	W/G/M	-	W/G/M	-	-	W/G/M	-	W/G/M
144	2	-	-	W/G/M	-	W/G/M	-	-	W/G/M	-	W/G/M
156	2	-	-	W/G/M	-	W/G/M	-	-	W/G/M	-	W/G/M
168	2	-	-	W/G/M	-	W/G/M	-	-	W/G/M	-	W/G/M
180	2	-	-	W/G/M	-	W/G/M	-	-	W/G/M	-	W/G/M
192	2	-	-	W/G/M	-	W/G/M	-	-	W/G/M	-	W/G/M
192	4	-	-	W/G/M	-	W/G/M	-	-	W/G/M	-	W/G/M
204	2	-	-	W/G/M	-	W/G/M	-	-	W/G/M	-	W/G/M
204	4	-	-	W/G/M	-	W/G/M	-	-	W/G/M	-	W/G/M
216	2	-	-	W/G/M	-	W/G/M	-	-	W/G/M	-	W/G/M
216	4	-	-	W/G/M	-	W/G/M	-	-	W/G/M	-	W/G/M
228	2	-	-	W/G/M	-	W/G/M	-	-	W/G/M	-	W/G/M
228	4	-	-	W/G/M	-	W/G/M	-	-	W/G/M	-	W/G/M
240	2	-	-	W/G/M	-	W/G/M	-	-	W/G/M	-	W/G/M
240	4	-	-	W/G/M	-	W/G/M	-	-	W/G/M	-	W/G/M

† Available on Media Tables only

\* Not offered on Media Tables, Standing Height Tables, or Counter Height Tables



# TABLE TOP POWER OPTION: POWER MATRIX

## POWER MATRIX SMALL OR MEDIUM LOCATION OPTIONS

Please Note: For floor core placement, please reference base location information on pages 39-46.

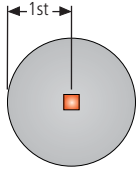

PS-1 or PM-1

PS-1 or PM-1	
Diameter	Center of Power Matrix
48	24
54	27
60	30

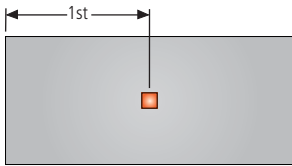

PS-1 or PM-1

PS-1 or PM-1	
Length	Center of Power Matrix
60	30
66	33
72	36
84	42
90	45
96	48
102	51
108	54
114	57
120	60

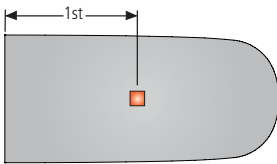

PS-1 or PM-1

PS-1 or PM-1	
Length	Center of Power Matrix
60	30
66	33
72	36
78	39
84	42
90	45
96	48



PS-1W or PM-1W\*

\*Available on Media Tables only

PS-1W or PM-1W*	
Length	Center of Power Matrix
60	7.5
66	7.5
72	7.5
78	7.5
84	7.5
90	7.5
96	7.5



# TABLE TOP POWER OPTION: POWER MATRIX

## POWER MATRIX SMALL OR MEDIUM LOCATION OPTIONS

Please Note: For floor core placement, please reference base location information on pages 39-46.

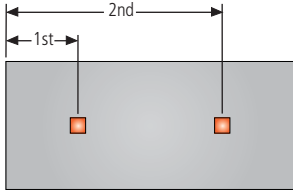

PS-2 or PM-2\*

\*Not offered on Media Tables, Standing Height Tables, or Counter Height Tables

PS-2 or PM-2*		
Length	Center of 1st Power Matrix	Center of 2nd Power Matrix
102	26	76
108	26	82
114	26	88
120	26	94
132	26	106
144	26	118
156	26	130
168	26	142
180	26	154
192	26	166
204	26	178
216	26	190
228	26	202
240	26	214

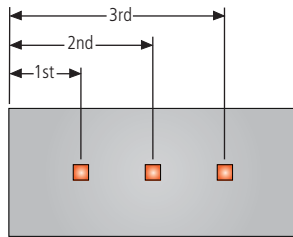

PS-3 or PM-3\*

\*Not offered on Media Tables, Standing Height Tables, or Counter Height Tables

PS-3 or PM-3*			
Length	Center of 1st Power Matrix	Center of 2nd Power Matrix	Center of 3rd Power Matrix
102	26	51	76
108	26	54	82
114	26	57	88
120	26	60	94

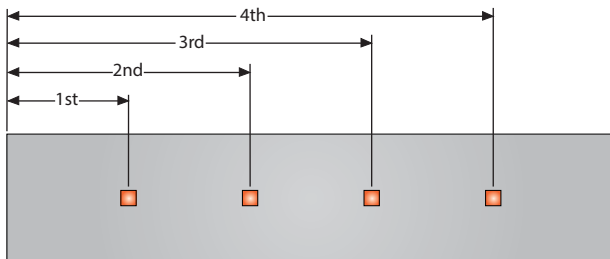

PS-4 or PM-4\*

\*Not offered on Media Tables, Standing Height Tables, or Counter Height Tables

PS-4 or PM-4*				
Length	Center of 1st Power Matrix	Center of 2nd Power Matrix	Center of 3rd Power Matrix	Center of 4th Power Matrix
132	26	53	79	106
144	26	57	87	118
156	26	61	95	130
168	26	65	103	142
180	26	69	111	154
192	26	73	119	166
204	26	77	127	178
216	26	81	135	190
228	26	85	143	202
240	26	89	151	214



# RETRACTORS FOR POWER MATRIX

## RETRACTORS

Cable retractors, for use with Power Matrix Small and Medium only, mount directly to the underside of conference room tables using the included mounting bracket. Loaded with 12' of cable that extends out 5' from the retractor. Retractors have a female input from the building infrastructure and a male connector on the output side. Not available on square, round or soft square tables.

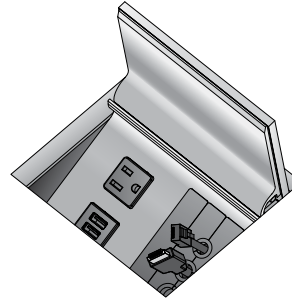

### RETRACTOR AVAILABILITY ON TWO4SIX TABLES X = AVAILABLE AS STANDARD

Length	PS-1/ PM-1	PS-2/ PM-2	PS-3/ PM-3	PS-4/ PM-4
72	X			
78	X			
84	X			
90	X			
96	X			
102	X	X		
108	X	X		
114	X	X	X	
120	X	X	X	
132		X		
144		X		X
156		X		X
168		X		X
180		X		X
192		X		X
204		X		X
216		X		X
228		X		X
240		X		X

### Retractor Wire Management

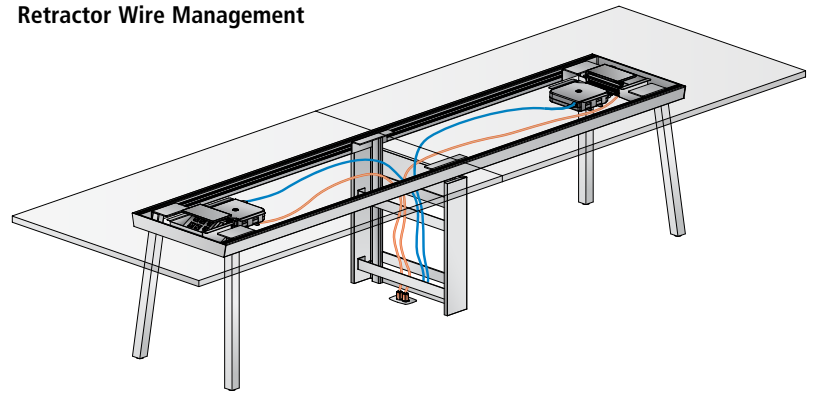

### CAT6 Retractor

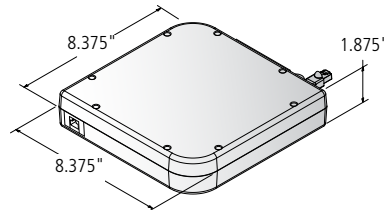

### HDMI Retractor

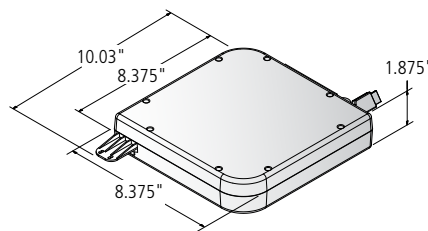

### Data USB Retractor

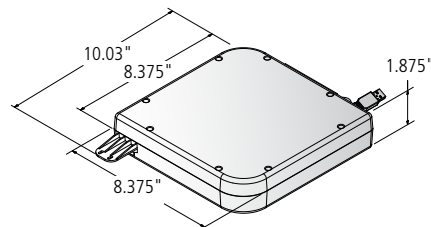





# TABLE TOP POWER OPTION: POWER CAP

## POWER CAP

Power Cap offers low profile yet robust power and data connectivity on the table surface. Power Cap is available in two sizes: Four Port and Two Port.

Four Port Power Cap configuration options:

- Two simplex receptacles and two USB-A+C chargers (Default Configuration)
- One simplex receptacle, one USB-A+C charger, and two blank Extron Architectural Adaptor Plates (AAPs)
- Two simplex receptacles and two blank AAPs

Two Port Power Cap configuration options:

- One simplex receptacle and one USB-A+C charger (Default Configuration)
- Two simplex receptacles

Intended for high use and quick access, Power Cap's low-profile aesthetic is non-lidded for ample space for plug heads of all sizes. The Power Cap metal faceplate is available in powder coat and polished chrome finish.

## DIMENSIONS

- Four Port Power Cap: 2" x 9"
- Two Port Power Cap: 2" x 5.5"
- Power Caps are 3/16" in height

Four Port Power Cap

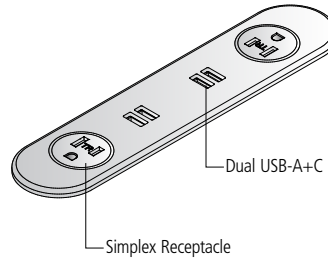

Four Port Default Configuration



Four Port Optional Configurations

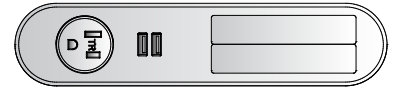
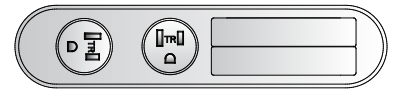

Two Port Power Cap

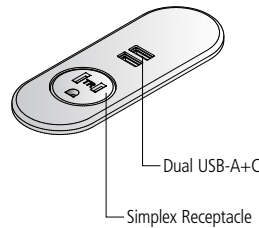

Two Port Default Configuration



Two Port Optional Configuration





# TABLE TOP POWER OPTION: POWER CAP

## POWER CAP FOR ROUND, SQUARE AND SOFT SQUARE TABLES

For round, square and soft square Meeting tables, Power Cap is available in the corresponding shape.

Two Port Power Cap configuration options:

- One simplex receptacle and one USB-A+C charger (Default Configuration)
- Two simplex receptacles

### DIMENSIONS

- Two Port Round Power Cap: 5" x 5"
- Two Port Square Power Cap: 5" x 5"
- Two Port Soft Square Power Cap: 5" x 5"
- Power Caps are 3/16" in height

Two Port Power Cap for Round Tables

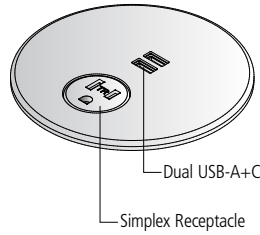

Two Port Round Default Configuration

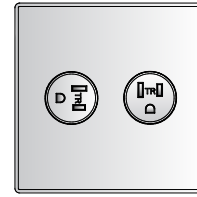

Two Port Round Optional Configuration

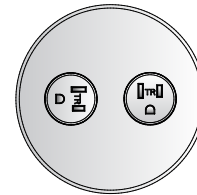

Two Port Power Cap for Square Tables

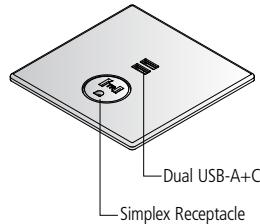

Two Port Square Default Configuration

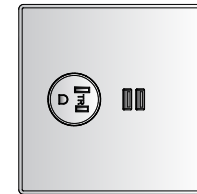

Two Port Square Optional Configuration

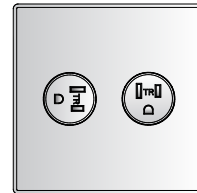

Two Port Power Cap for Soft Square Tables

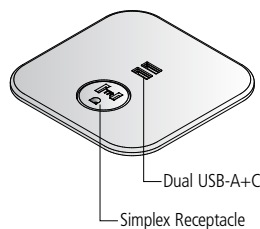

Two Port Soft Square Default Configuration

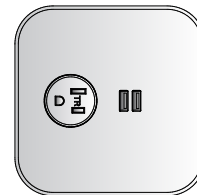

Two Port Soft Square Optional Configuration

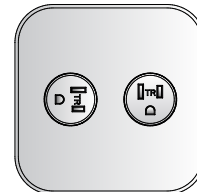



# TABLE TOP POWER OPTION: POWER CAP

## LOCATION CODES

Power Cap is offered in a variety of locations and quantities per table size, offering a broad range of performance and pricing options.

POWER CAP	DESCRIPTION	LOCATION	QUANTITY OF UNITS TO ORDER
CP4-1	Power Cap 4 Port Racetrack Shape	One at Center	1
CP4-1W	Power Cap 4 Port Racetrack Shape (Media Table)	One at End (Media Table Only)	1
CP4-2	Power Cap 4 Port Racetrack Shape	One at Each End	2
CP4-3	Power Cap 4 Port Racetrack Shape	3 Equally Spaced (starting at 96")	3
CP4-4	Power Cap 4 Port Racetrack Shape	4 Equally Spaced (starting at 132")	4
CP2-1	Power Cap 2 Port Racetrack Shape	One at Center	1
CP2-1W	Power Cap 2 Port Racetrack Shape (Media Table)	One at End (Media Table Only)	1
CP2-2	Power Cap 2 Port Racetrack Shape	One at Each End	2
CP2-3	Power Cap 2 Port Racetrack Shape	3 Equally Spaced (starting at 96")	3
CP2-4	Power Cap 2 Port Racetrack Shape	4 Equally Spaced (starting at 132")	4
CPS2-1	Power Cap 2 Port Soft Square Shape (Soft Square Tables only)	One at Center	1
CPR2-1	Power Cap 2 Port Round Shape (Round Tables Only)	One at Center	1
CPQ2-1	Power Cap 2 Port Square Shape (Square Tables Only)	One at Center	1

## POWER CAP LOCATION OPTIONS

Please Note: For floor core placement, please reference base location information on pages 39-46.

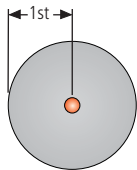

CPS2-1, CPR2-1 or CPQ2-1

### CPS2-1, CPR2-1 or CPQ2-1

Diameter	Center of Power Cap
48	24
54	27
60	30

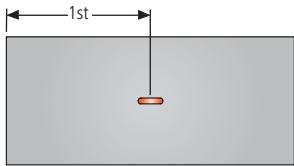

CP4-1 or CP2-1

### CP4-1 or CP2-1

Length	Center of Power Cap
60	30
66	33
72	36
84	42
90	45
96	48
102	51
108	54
114	57
120	60



# TABLE TOP POWER OPTION: POWER CAP

## POWER CAP LOCATION OPTIONS

Please Note: For floor core placement, please reference base location information on pages 39-46.

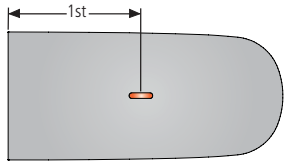

CP4-1 or CP2-1

CP4-1 or CP2-1	
Length	Center of Power Cap
60	30
66	33
72	36
78	39
84	42
90	45
96	48

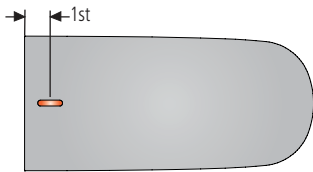

CP4-1W or CP2-1W\*

\*Available on Media Tables only

CP4-1W or CP2-1W*	
Length	Center of Power Cap
60	7.5
66	7.5
72	7.5
78	7.5
84	7.5
90	7.5
96	7.5

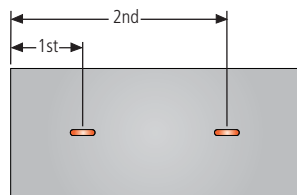

CP4-2 or CP2-2\*

\*Not offered on Media Tables, Standing Height Tables, or Counter Height Tables

CP4-2 or CP2-2*		
Length	Center of 1st Power Cap	Center of 2nd Power Cap
102	26	76
108	26	82
114	26	88
120	26	94
132	26	106
144	26	118
156	26	130
168	26	142
180	26	154
192	26	166
204	26	178
216	26	190
228	26	202
240	26	214



# TABLE TOP POWER OPTION: POWER CAP

## POWER CAP LOCATION OPTIONS

**Please Note:** For floor core placement, please reference base location information on pages 39-46.

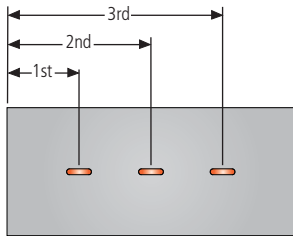

CP4-3 or CP2-3\*

\*Not offered on Media Tables, Standing Height Tables, or Counter Height Tables

CP4-3 or CP2-3*			
Length	Center of 1st Power Cap	Center of 2nd Power Cap	Center of 3rd Power Cap
102	26	51	76
108	26	54	82
114	26	57	88
120	26	60	94

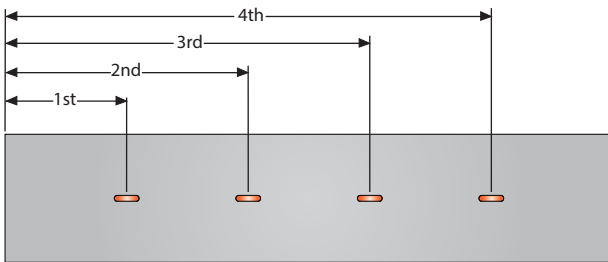

CP4-4 or CP2-4\*

\*Not offered on Media Tables, Standing Height Tables, or Counter Height Tables

CP4-4 or CP2-4*				
Length	Center of 1st Power Cap	Center of 2nd Power Cap	Center of 3rd Power Cap	Center of 4th Power Cap
132	26	53	79	106
144	26	57	87	118
156	26	61	95	130
168	26	65	103	142
180	26	69	111	154
192	26	73	119	166
204	26	77	127	178
216	26	81	135	190
228	26	85	143	202
240	26	89	151	214



# TABLE TOP POWER OPTION: TECH NODE

Tech Node offers convenient access to power and voice/data connections. Tech Node features include a push/push open design that conceals internal components.

Tech Node components:

- Clear or Black Anodized Aluminum
- Fluid one touch accessibility
- Two (2) Simplexes
- Up to two voice/data ports
- 12' 15-Amp cord
- Voice/Data Adapter Kit p/n BE01421 to accept couplers & jacks
- UL Listed
- Overall dimensions - 4-7/16" x 8-5/16"
- Optional powered USB-A+C

All electrical components are UL listed.

Tech Node - Cover Open

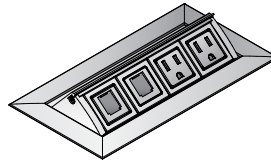

Tech Node - Cover Open with Optional USB-A+C

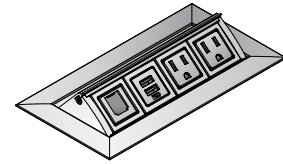

Tech Node - Cover Closed

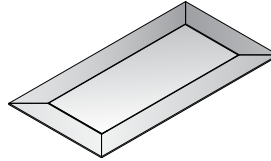

Tech Node - Open Front View

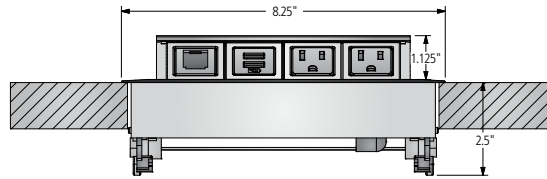

Tech Node - Open Side View

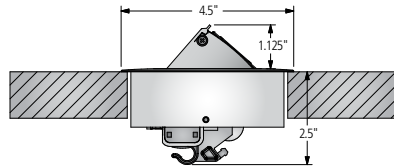

## VOICE/DATA PLANNING

Two (2) simplex voice/data cutouts accept customer supplied, field-installed snap-in connectors.

Nucraft recommends consulting an audio/visual (AV) integrator for assistance with voice/data planning.

## Voice/Data Product Manufacturers

Manufacturer	Phone Number	Web Site
AMP	1-800-522-6752	<a href="http://www.tycoelectronics.com">www.tycoelectronics.com</a>
Avaya	1-866-462-8292	<a href="http://www.avaya.com">www.avaya.com</a>
Leviton	1-800-722-2082	<a href="http://www.leviton.com">www.leviton.com</a>
Panduit	1-800-777-3300	<a href="http://www.panduit.com">www.panduit.com</a>
Siemon	1-860-945-4200	<a href="http://www.siemon.com">www.siemon.com</a>

## LOCATION CODES

TECH NODE	LOCATION	QUANTITY OF UNITS TO ORDER
TN-1	One at center	1
TN-1W	One at wall end (Media Table only)	1
TN-2*	One at each end	2
TN-3*	One at center and one at each end	3
TN-4*	Four equally spaced	4

\*TN-2, TN-3 and TN-4 not offered on Media Tables, Standing Height Tables, or Counter Height Tables



# TABLE TOP POWER OPTION: TECH NODE

## TECH NODE LOCATION OPTIONS

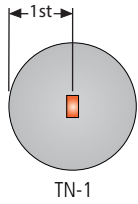

TN-1	
Length	Center of Tech Node
48	24
54	27
60	30
66	33

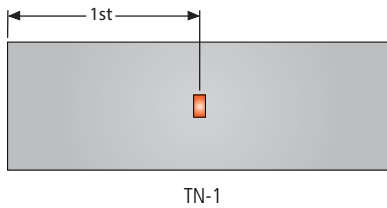

TN-1	
Length	Center of Tech Node
72	36
84	42
90	45
96	48
102	51
108	54
114	57
120	60

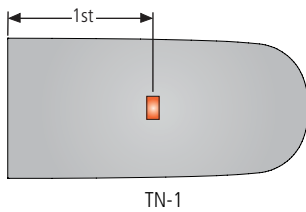

TN-1	
Length	Center of Tech Node
60	30
66	33
72	36
78	39
84	42
90	45
96	48

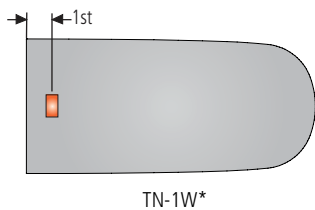

TN-1W*	
Length	Center of Tech Node
60	7.5
66	7.5
72	7.5
78	7.5
84	7.5
90	7.5
96	7.5

\*Available on Media Tables only



# TABLE TOP POWER OPTION: TECH NODE

## TECH NODE LOCATION OPTIONS

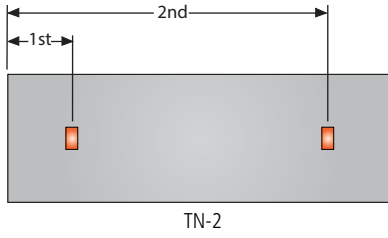

TN-2		
Length	Center of 1st Tech Node	Center of 2nd Tech Node
102	26	76
108	26	82
114	26	88
120	26	94
132	26	106
144	26	118
156	26	130
168	26	142
180	26	154
192	26	166
204	26	178
216	26	190
228	26	202
240	26	214

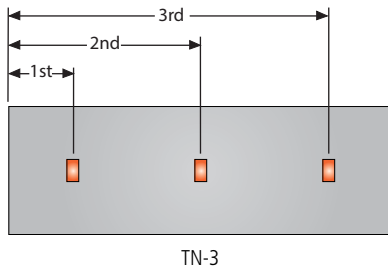

TN-3			
Length	Center of 1st Tech Node	Center of 2nd Tech Node	Center of 3rd Tech Node
102	26	51	76
108	26	54	82
114	26	57	88
120	26	60	94

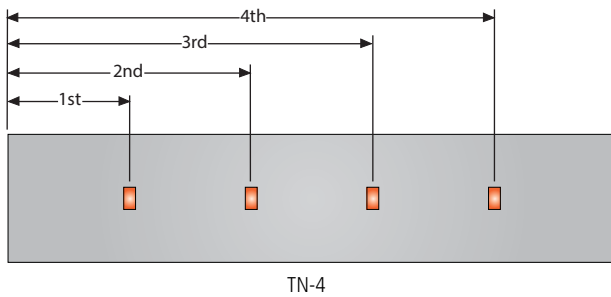

TN-4				
Length	Center of 1st Tech Node	Center of 2nd Tech Node	Center of 3rd Tech Node	Center of 4th Tech Node
132	26	53	79	106
144	26	57	87	118
156	26	61	95	130
168	26	65	103	142
180	26	69	111	154
192	26	73	119	166
204	26	77	127	178
216	26	81	135	190
228	26	85	143	202
240	26	89	151	214





# TABLE TOP POWER OPTION: POWER SPEC AND USB SPEC

## POWER SPEC AND USB SPEC

This compact unit allows for the addition of power or data to a work surface in a discreet way. Available in round or square shapes, and multiple finish options.

### Power Spec

- Spill-proof power simplex
- Compact design
- 1-3/4" cutout for installation
- UL Listed

Power Spec

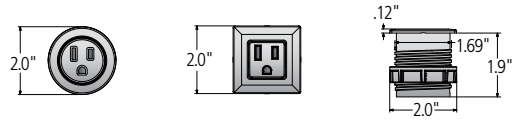

### USB Spec

- Used to charge devices or transfer data
- Compact design
- Offered with USB-A+C
- 1-3/4" cutout for installation
- UL Listed

USB Spec

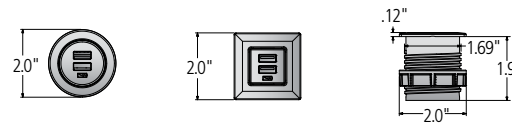



# TABLE TOP POWER OPTION: POWER RAIL

## POWER RAIL

This low-profile option addresses the need for power & data connectivity just below the table top. This is an ideal choice for those who desire a visually uninterrupted table top and appreciate the inherent flexibility of the Power Rail to be removed at a later date as they transition to a truly wireless environment.

Held in place with screws, Power Rail units can be placed anywhere along the perimeter of the table. This flexible mounting design allows for additional units to be added as necessary, or to be removed when no longer needed.

Power Rails are available in three configurations:

- Two simplex receptacles (UL Listed)
- One simplex receptacle and one powered USB-A+C connector (UL Listed)
- Two single space A/V faceplates designed for use with Extron Architectural Adaptor Plates (AAPs)

When Power Rails are specified on a Two4Six table, a direct plug-in infeed or hardwired option is available. The direct plug-in infeed option has a single circuit electrical system and the hardwire option requires a two-circuit electrical system. Maximum of 12 Power Rails per table.

Front Elevation

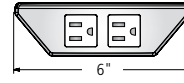

Side Elevation

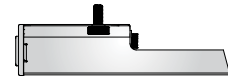
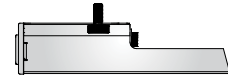
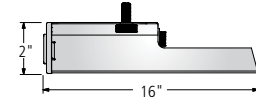



# TABLE TOP POWER OPTION: CHARGING TRAC

## CHARGING TRAC

Charging Trac is a low voltage, under surface power system with 2 USB-A ports per unit. It's modular configuration provides a customizable solution. Offered in a 2 or 4 unit kit of parts with a plug-in infeed. USB-A compatible.

### Charging Trac Wire Management (Flow table with rectangle bases shown)

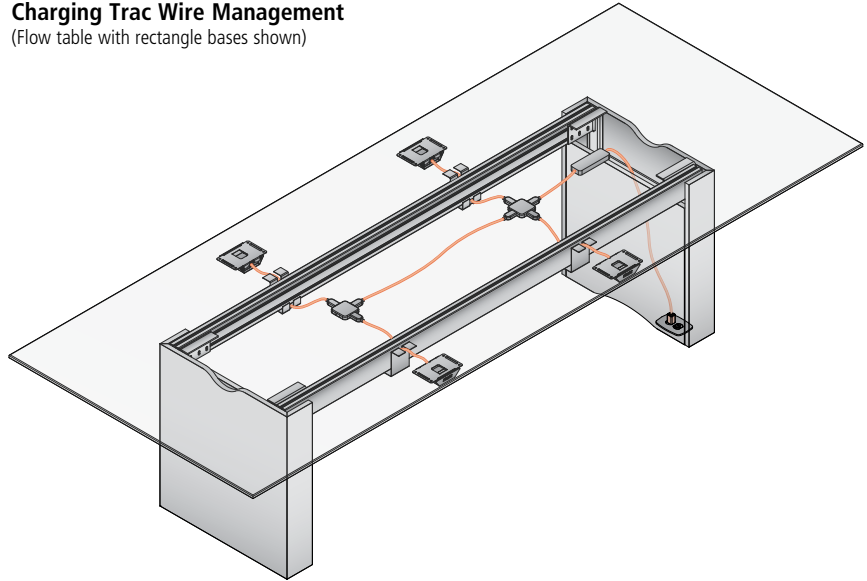

Front Elevation

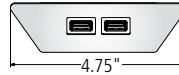

Side Elevation

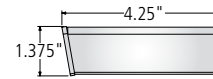

### Two-Unit Configuration includes:

- 2 Brackets, each bracket offers 2 USB-A ports
- 1 Puck
- 1 Plug-in infeed

### Two-Unit Configuration

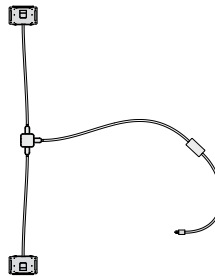

### Four-Unit Configuration includes:

- 4 Brackets, each bracket offers 2 USB-A ports
- 2 Pucks
- Jumpers
- 1 Plug-in infeed

### Four-Unit Configuration

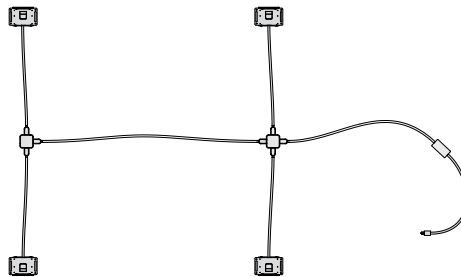



# FREESTANDING POWER OPTION: TECH ZONE

## TECH ZONE

Simple, easy to use and portable, this freestanding table top power option allows you to easily charge all of your devices.

Available in two configurations with a variety of power and data connectivity options. Includes a 72"-long plug-in infeed cord.

### ZONE-USB-C

Includes two simplex receptacles, one data port and one charging USB-A+C charging port

### ZONE-DATA

Includes two simplex receptacles and two open data ports

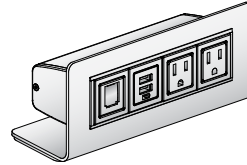

Tech Zone - Side View

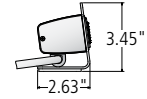

ZONE-USB-C



ZONE-DATA





# POWER PLANNING

## WIRE MANAGEMENT

An aluminum wire management channel, included with each Two4Six table specified with the Post Leg or Open Frame base, can be adhered to the base and can accommodate power and data cables. The wire management channel comes in the same finishes as the Post Leg or Open Frame base.

For more robust needs, a 6"-square Power Pole with metal shrouds, available in any of the powder coat colors, can be specified separately and placed anywhere along the centerline of the table to manage and conceal cables as well as cover a floor monument.

**Wire Management Channel**



**Top View Post Leg with Wire Management Channel**

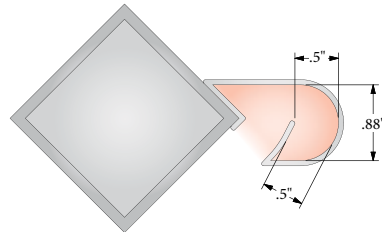

**Power Pole**

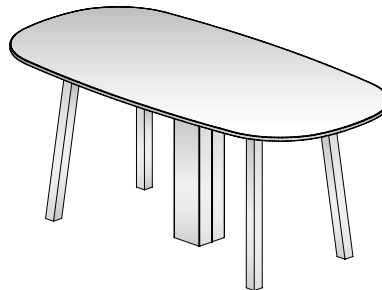



# WIRE MANAGEMENT OPENINGS

## Cylinder Base

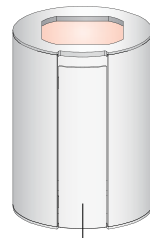

Hinged Access Door  
7.5" W x 24.875" H

18"

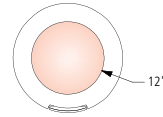

48" Diameter Tops

20"

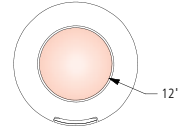

54" Diameter Tops

24"

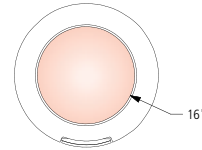

60" Diameter Tops

## Slab Base



Must be anchored  
to a wall, with or  
without Slab Base

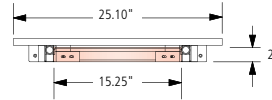

30"-Wide Tops

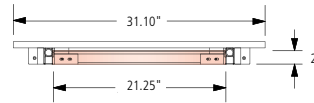

36"-Wide Tops

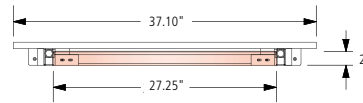

42"-Wide Tops

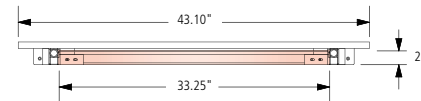

48"-Wide Tops



# WIRE MANAGEMENT OPENINGS

---

Rectangle Media Table Base

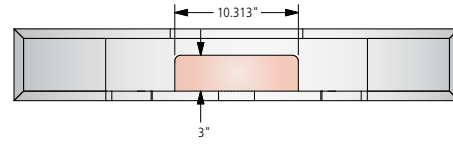
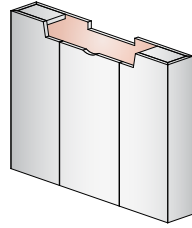



# WIRE MANAGEMENT OPENINGS

## Credenza Base

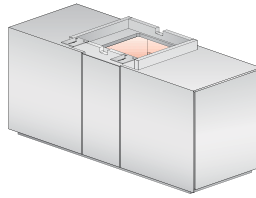

### 60" - Top Panel Cutout

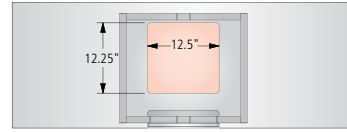

30" - 48"-Wide Tops

### 60" - Back Panel Cutout

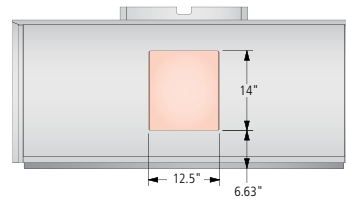

30" - 48"-Wide Tops

### 72" - Top Panel Cutout

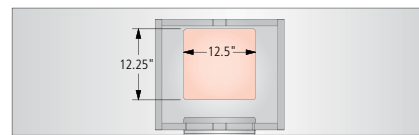

30" - 48"-Wide Tops

### 72" - Back Panel Cutout

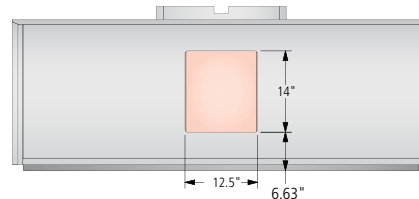

30" - 48"-Wide Tops

## Adjustable Height Base

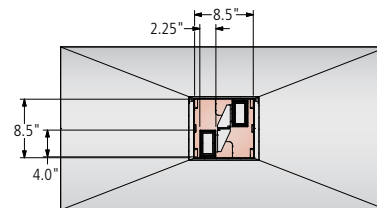





# WIRE MANAGEMENT OPENINGS

## Rectangle Center Base

The Rectangle Center Base has a removable access door, whether or not power has been specified on the table.

For wire management purposes, the access door features a scallop through which cables may pass. When shipped, the scallop is in the top position of the door. The access door may be rotated, however, placing the scallop in the bottom position as shown in the illustration, if needed based on the floor core location.

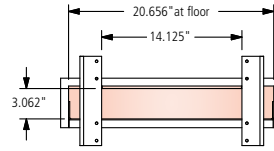
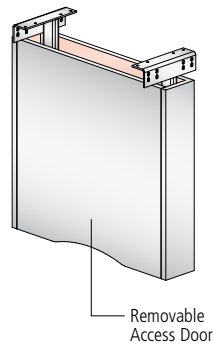

42"-Wide Tops

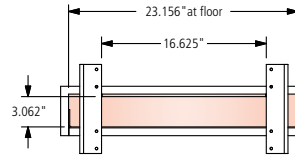

48"-Wide Tops

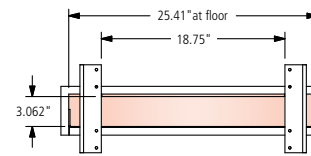

54"-Wide Tops

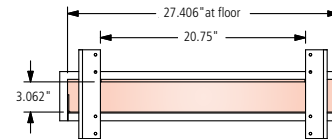

60"-Wide Tops

## Racetrack Base

The Racetrack Base has a removable access door on the inside of the base, whether or not power has been specified on the table.

For wire management purposes, the access door features a scallop through which cables may pass. When shipped, the scallop is in the top position of the door. The access door may be rotated, however, placing the scallop in the bottom position as shown in the illustration, if needed based on the floor core location.

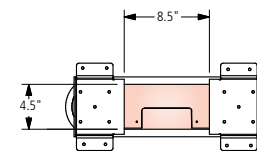
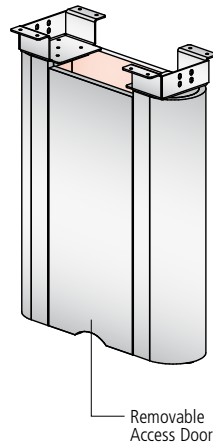

42"-Wide Tops

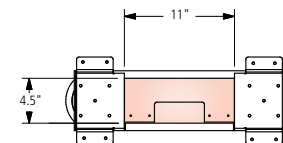

48", 54" & 60"-Wide Tops

For tables that require three bases, the center Racetrack base also has a removable access door, but on only one side of the base.



# WIRE MANAGEMENT OPENINGS

X Center Base

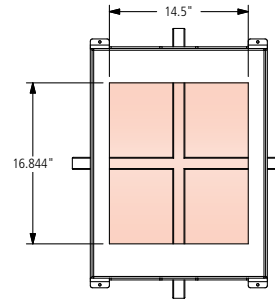
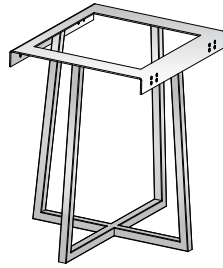

42"-Wide Tops

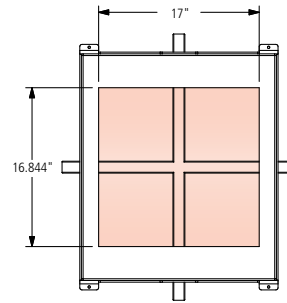

48"-Wide Tops

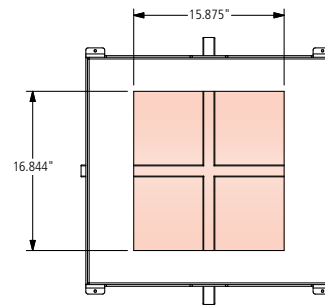

54"-Wide Tops

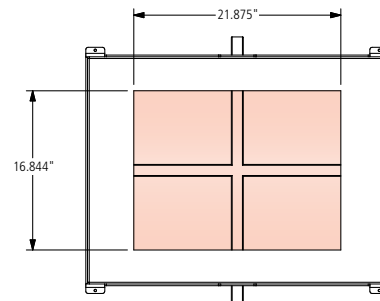

60"-Wide Tops



# BASE DIMENSIONS

## Open Frame Seated Height Base

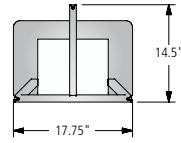
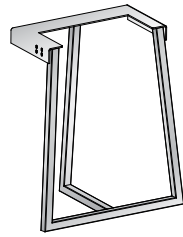

30"-Wide Tops

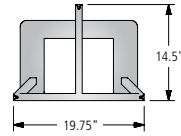

36"-Wide Tops

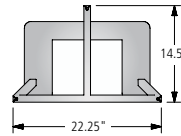
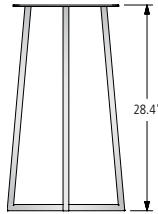

42"-Wide Tops

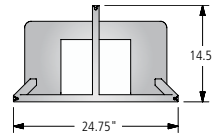

48"-Wide Tops

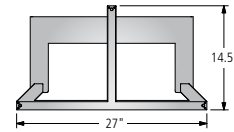

54"-Wide Tops

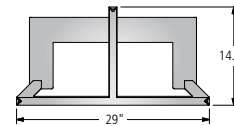

60"-Wide Tops

## Open Frame Standing Height Base (for use with Slab Base)

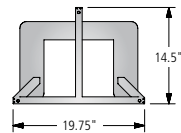
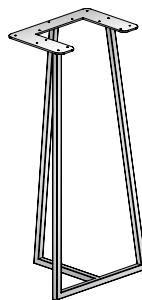

30" - 48"-Wide Tops

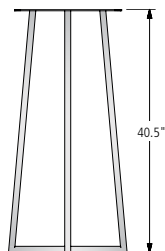



# BASE DIMENSIONS

## Open Frame Square Base

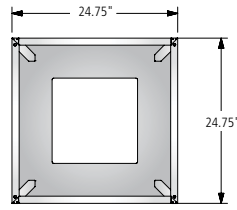
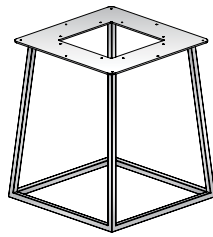

48"-Wide Tops

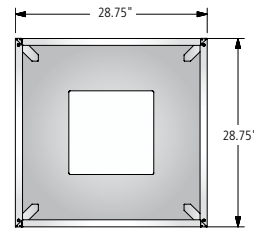
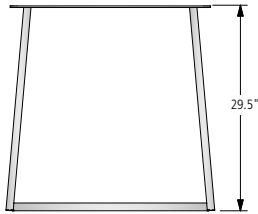

54"-Wide Tops

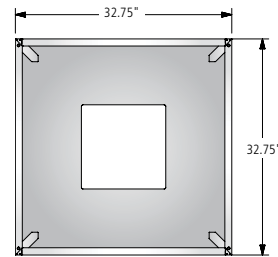

60"-Wide Tops

## Adjustable Height Base

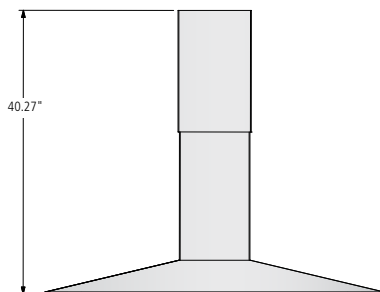
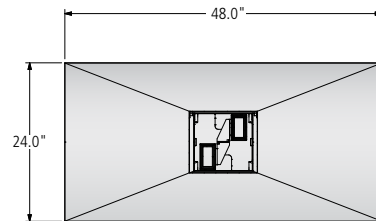
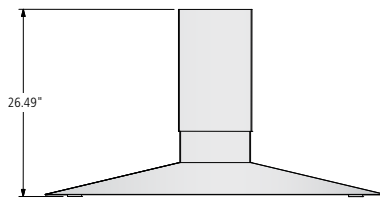

# BASE DIMENSIONS

## Rectangle Center Base

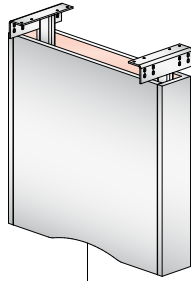

Rectangle Center Base ships with the scallop in the top position. The access door may be rotated, however, placing the scallop in the the bottom position as shown for wire management.

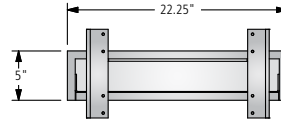

42"-Wide Tops

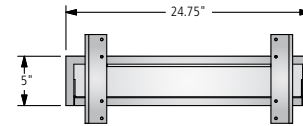

48"-Wide Tops

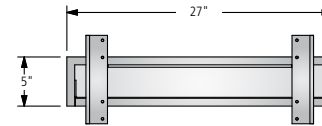

54"-Wide Tops

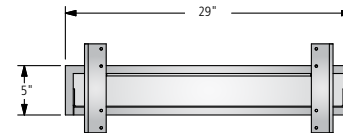

60"-Wide Tops

## Racetrack Base

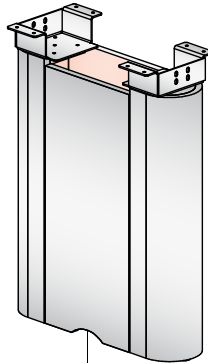

Racetrack Base ships with the scallop in the top position. The access door may be rotated, however, placing the scallop in the the bottom position as shown for wire management.

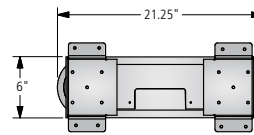

42"-Wide Tops

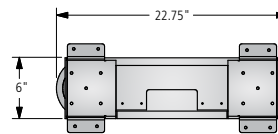

48"-Wide Tops

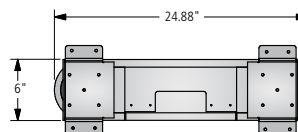

54"-Wide Tops

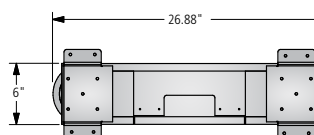

60"-Wide Tops



# BASE DIMENSIONS

X Center Base

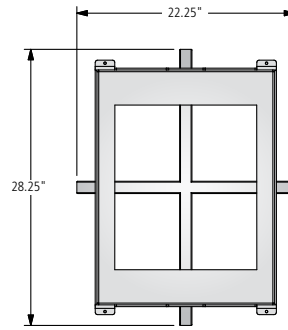
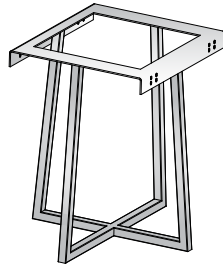

42"-Wide Tops

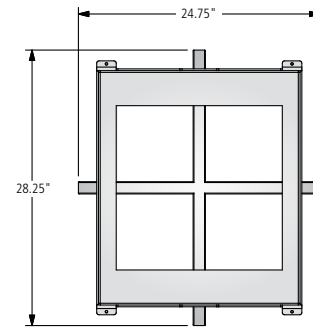

48"-Wide Tops

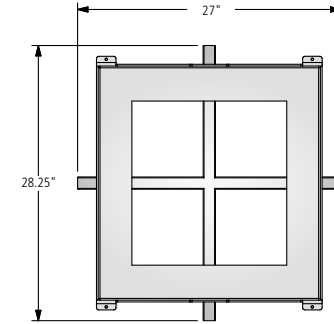

54"-Wide Tops

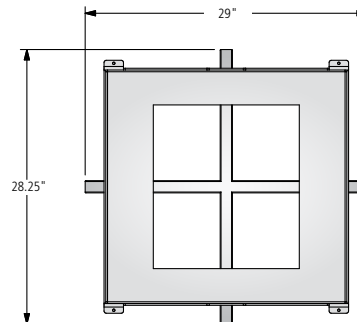

60"-Wide Tops



# BASE LOCATIONS

## ROUND, SQUARE AND SOFT SQUARE TABLES WITH POST LEGS

Two4Six tables in Round, Square, and Rectangle shapes include two leg mounting locations for Post Legs; the standard location (where the bottom of each leg is close to the edge of the table) and an inset position (where the leg is inset slightly for an alternate aesthetic). The inset position on the Rectangle table is ideal if the meeting table is going to be used as a desk. The charts on the following pages indicate the positioning of the Post Legs (in this inset position) as well as the Open Frame bases on Two4Six Meeting tables to assist with floor monument locations.

### Inset Leg Dimensions

(as measured from the edge of the table top to the center of the glide)

#### Round

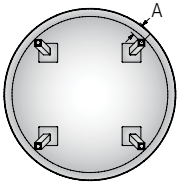

Note: This is the only Post Leg position.

Table Size	Base	A
48"	Post Leg	3.6
54"	Post Leg	3.6
60"	Post Leg	3.6

#### Square

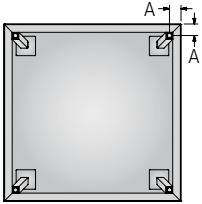

Note: This is the only Post Leg position.

Table Size	Base	A
48"	Post Leg	3.2
54"	Post Leg	3.2
60"	Post Leg	3.2

#### Soft Square

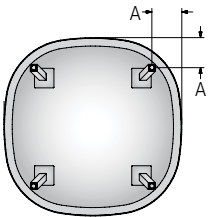

Note: This is the only Post Leg position.

Table Size	Base	A
48"	Post Leg	8.1
54"	Post Leg	8.8
60"	Post Leg	9.5



# BASE LOCATIONS

## ROUND, SQUARE AND SOFT SQUARE TABLES WITH OPEN FRAME SQUARE BASE

### Open Frame Square Base Dimensions

(as measured from the edge of the table top to the center of the glide)

#### Round

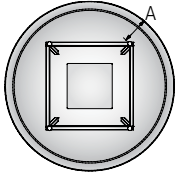

Table Size	Base	A
48"	Open Frame	7.6
54"	Open Frame	7.7
60"	Open Frame	7.9

#### Square

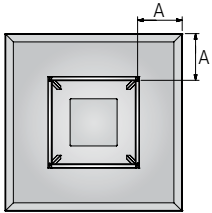

Table Size	Base	A
48"	Open Frame	12.5
54"	Open Frame	13.5
60"	Open Frame	14.5

#### Soft Square

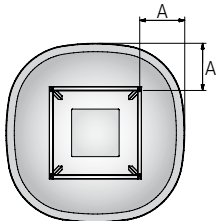

Table Size	Base	A
48"	Open Frame	12.5
54"	Open Frame	13.5
60"	Open Frame	14.5





# BASE LOCATIONS

## RECTANGLE TABLE WITH POST LEGS

Rectangle-shaped tables have two mounting location options for Metal Post Legs: inset, where the legs are mounted inset of the edge of the table, and outset, where the legs are mounted at the corners of the table. The outset option is available on tables from 60" to 96"-long.

### Outset Leg Dimensions

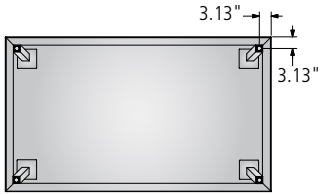

Note: Outset Leg option available on tables between 60" to 96" L.

### Inset Leg Dimensions

Sizes 60" to 96" L

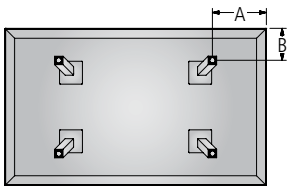

Sizes 102" to 144" L



Table Size	Base	A (End)	B (Side)
60 x 30	Post Leg	12.4	4.4
66 x 30	Post Leg	12.4	4.4
72 x 30	Post Leg	12.4	4.4
78 x 30	Post Leg	15.9	4.4
84 x 30	Post Leg	15.9	4.4
90 x 30	Post Leg	15.9	4.4
96 x 30	Post Leg	15.9	4.4
60 x 36	Post Leg	12.4	7.4
66 x 36	Post Leg	12.4	7.4
72 x 36	Post Leg	12.4	7.4
78 x 36	Post Leg	15.9	7.4
84 x 36	Post Leg	15.9	7.4
90 x 36	Post Leg	15.9	7.4
96 x 36	Post Leg	15.9	7.4
60 x 42	Post Leg	12.4	10.4
66 x 42	Post Leg	12.4	10.4
72 x 42	Post Leg	12.4	10.4
78 x 42	Post Leg	15.9	10.4
84 x 42	Post Leg	15.9	10.4
90 x 42	Post Leg	15.9	10.4
96 x 42	Post Leg	15.9	10.4
60 x 48	Post Leg	12.4	12.1
66 x 48	Post Leg	12.4	12.1
72 x 48	Post Leg	12.4	12.1
78 x 48	Post Leg	15.9	12.1
84 x 48	Post Leg	15.9	12.1
90 x 48	Post Leg	15.9	12.1
96 x 48	Post Leg	15.9	12.1
102 x 42	Post Leg	20.5	10.4
102 x 48	Post Leg	20.5	12.2
108 x 42	Post Leg	20.5	10.4
108 x 48	Post Leg	20.5	12.2
108 x 54	Post Leg	20.5	14.1
114 x 42	Post Leg	20.5	10.4
114 x 48	Post Leg	20.5	12.2
114 x 54	Post Leg	20.5	14.1
120 x 42	Post Leg	20.5	10.4
120 x 48	Post Leg	20.5	12.2
120 x 54	Post Leg	20.5	14.1
132 x 42	Post Leg	20.5	10.4
132 x 48	Post Leg	20.5	12.2
132 x 54	Post Leg	20.5	14.1
144 x 48	Post Leg	20.5	12.2
144 x 54	Post Leg	20.5	14.1
144 x 60	Post Leg	20.5	16.1

# BASE LOCATIONS

## SOFT RECTANGLE TABLE WITH POST LEGS

### Inset Leg Dimensions

Note: This is the only Post Leg position on Soft Rectangle tables.

Sizes 60" to 96"L

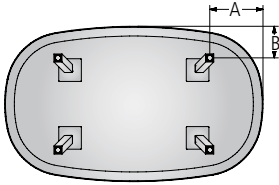

Sizes 102" to 144"L

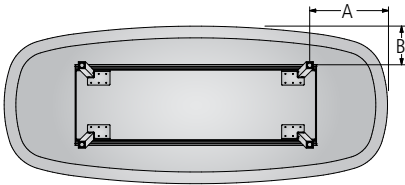

Table Size	Base	A (End)	B (Side)
60 x 30	Post Leg	12.2	4.4
66 x 30	Post Leg	12.2	4.4
72 x 30	Post Leg	12.2	4.4
78 x 30	Post Leg	15.7	4.4
84 x 30	Post Leg	15.7	4.4
90 x 30	Post Leg	15.7	4.4
96 x 30	Post Leg	15.7	4.4
60 x 36	Post Leg	12.2	7.4
66 x 36	Post Leg	12.2	7.4
72 x 36	Post Leg	12.2	7.4
78 x 36	Post Leg	15.7	7.4
84 x 36	Post Leg	15.7	7.4
90 x 36	Post Leg	15.7	7.4
96 x 36	Post Leg	15.7	7.4
60 x 42	Post Leg	12.2	10.4
66 x 42	Post Leg	12.2	10.4
72 x 42	Post Leg	12.2	10.4
78 x 42	Post Leg	15.7	10.4
84 x 42	Post Leg	15.7	10.4
90 x 42	Post Leg	15.7	10.4
96 x 42	Post Leg	15.7	10.4
60 x 48	Post Leg	12.2	12.1
66 x 48	Post Leg	12.2	12.1
72 x 48	Post Leg	12.2	12.1
78 x 48	Post Leg	15.7	12.1
84 x 48	Post Leg	15.7	12.1
90 x 48	Post Leg	15.7	12.1
96 x 48	Post Leg	15.7	12.1
102 x 42	Post Leg	20.5	10.4
102 x 48	Post Leg	20.5	12.2
108 x 42	Post Leg	20.5	10.4
108 x 48	Post Leg	20.5	12.2
108 x 54	Post Leg	20.5	14.1
114 x 42	Post Leg	20.5	10.4
114 x 48	Post Leg	20.5	12.2
114 x 54	Post Leg	20.5	14.1
120 x 42	Post Leg	20.5	10.4
120 x 48	Post Leg	20.5	12.2
120 x 54	Post Leg	20.5	14.1
132 x 42	Post Leg	20.5	10.4
132 x 48	Post Leg	20.5	12.2
132 x 54	Post Leg	20.5	14.1
144 x 48	Post Leg	20.5	12.2
144 x 54	Post Leg	20.5	14.1
144 x 60	Post Leg	20.5	16.1



# BASE LOCATIONS

## RECTANGLE AND SOFT RECTANGLE TABLES WITH POST LEGS AND RECTANGLE CENTER BASE

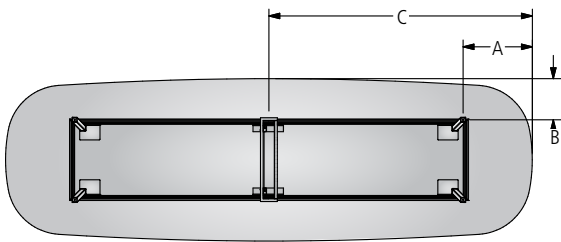
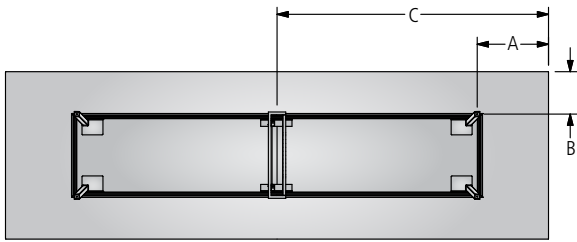

Table Size	Base	A (End)	B (Side)	C (Center)
156 x 48	Post Leg	20.5	12.2	78
156 x 54	Post Leg	20.5	14.1	78
156 x 60	Post Leg	20.5	16.1	78
168 x 54	Post Leg	20.5	14.1	84
168 x 60	Post Leg	20.5	16.1	84
180 x 54	Post Leg	20.5	14.1	90
180 x 60	Post Leg	20.5	16.1	90
192 x 54	Post Leg	20.5	14.1	96
192 x 60	Post Leg	20.5	16.1	96
204 x 54	Post Leg	20.5	14.1	102
204 x 60	Post Leg	20.5	16.1	102
216 x 54	Post Leg	20.5	14.1	108
216 x 60	Post Leg	20.5	16.1	108
228 x 54	Post Leg	20.5	14.1	114
228 x 60	Post Leg	20.5	16.1	114
240 x 54	Post Leg	20.5	14.1	120
240 x 60	Post Leg	20.5	16.1	120



# BASE LOCATIONS

## RECTANGLE AND SOFT RECTANGLE TABLES WITH OPEN FRAME

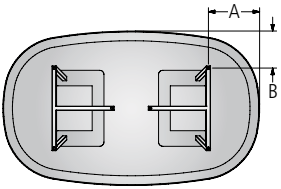
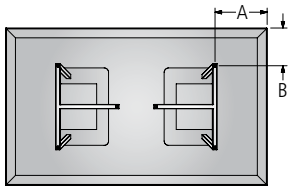

Table Size	Base	A (End)	B (Side)
60 x 30	Open Frame	12	6.8
66 x 30	Open Frame	12	6.8
72 x 30	Open Frame	12	6.8
78 x 30	Open Frame	15.5	6.8
84 x 30	Open Frame	15.5	6.8
90 x 30	Open Frame	15.5	6.8
96 x 30	Open Frame	15.5	6.8
60 x 36	Open Frame	12	8.6
66 x 36	Open Frame	12	8.6
72 x 36	Open Frame	12	8.6
78 x 36	Open Frame	15.5	8.6
84 x 36	Open Frame	15.5	8.6
90 x 36	Open Frame	15.5	8.6
96 x 36	Open Frame	15.5	8.6
60 x 42	Open Frame	12	10.4
66 x 42	Open Frame	12	10.4
72 x 42	Open Frame	12	10.4
78 x 42	Open Frame	15.5	10.4
84 x 42	Open Frame	15.5	10.4
90 x 42	Open Frame	15.5	10.4
96 x 42	Open Frame	15.5	10.4
60 x 48	Open Frame	12	12.1
66 x 48	Open Frame	12	12.1
72 x 48	Open Frame	12	12.1
78 x 48	Open Frame	15.5	12.1
84 x 48	Open Frame	15.5	12.1
90 x 48	Open Frame	15.5	12.1
96 x 48	Open Frame	15.5	12.1
102 x 42	Open Frame	20.5	10.4
102 x 48	Open Frame	20.5	12.1
108 x 42	Open Frame	20.5	10.4
108 x 48	Open Frame	20.5	12.1
108 x 54	Open Frame	20.5	14.1
114 x 42	Open Frame	20.5	10.4
114 x 48	Open Frame	20.5	12.1
114 x 54	Open Frame	20.5	14
120 x 42	Open Frame	20.5	10.4
120 x 48	Open Frame	20.5	12.1
120 x 54	Open Frame	20.5	14
132 x 42	Open Frame	20.5	10.4
132 x 48	Open Frame	20.5	12.1
132 x 54	Open Frame	20.5	14
144 x 48	Open Frame	20.5	12.1
144 x 54	Open Frame	20.5	14
144 x 60	Open Frame	20.5	16



# BASE LOCATIONS

## RECTANGLE AND SOFT RECTANGLE TABLES WITH OPEN FRAME AND X CENTER BASE

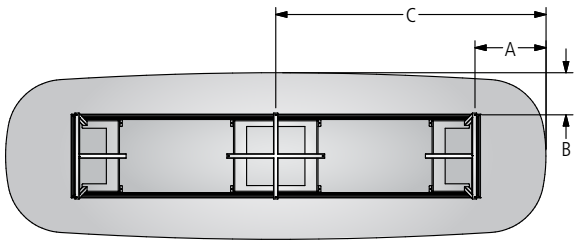
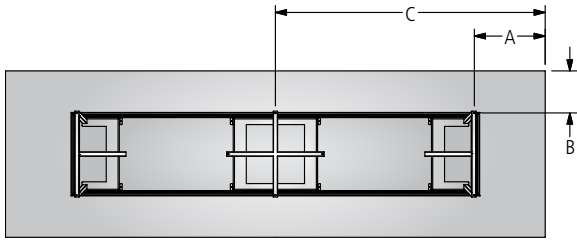

Table Size	Base	A (End)	B (Side)	C (Center)
156 x 48	Open Frame	20.5	12.1	78
156 x 54	Open Frame	20.5	14	78
156 x 60	Open Frame	20.5	16	78
168 x 54	Open Frame	20.5	14	84
168 x 60	Open Frame	20.5	16	84
180 x 54	Open Frame	20.5	14	90
180 x 60	Open Frame	20.5	16	90
192 x 54	Open Frame	20.5	14	96
192 x 60	Open Frame	20.5	16	96
204 x 54	Open Frame	20.5	14	102
204 x 60	Open Frame	20.5	16	102
216 x 54	Open Frame	20.5	14	108
216 x 60	Open Frame	20.5	16	108
228 x 54	Open Frame	20.5	14	114
228 x 60	Open Frame	20.5	16	114
240 x 54	Open Frame	20.5	14	120
240 x 60	Open Frame	20.5	16	120



# BASE LOCATIONS

## RECTANGLE AND SOFT RECTANGLE TABLES WITH RACETRACK BASE

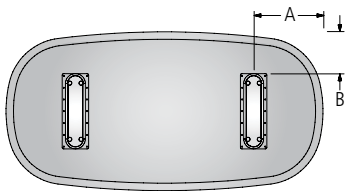
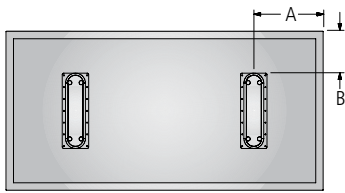

Table Size	Base	A (End)	B (Side)
72 x 42	Racetrack	21	10.38
78 x 42	Racetrack	21	10.38
84 x 42	Racetrack	21	10.38
90 x 42	Racetrack	21	10.38
96 x 42	Racetrack	21	10.38
72 x 48	Racetrack	21	12.63
78 x 48	Racetrack	21	12.63
84 x 48	Racetrack	21	12.63
90 x 48	Racetrack	21	12.63
96 x 48	Racetrack	21	12.63
102 x 42	Racetrack	26	10.38
102 x 48	Racetrack	26	12.63
108 x 42	Racetrack	26	10.38
108 x 48	Racetrack	26	12.63
108 x 54	Racetrack	26	14.56
114 x 42	Racetrack	26	10.38
114 x 48	Racetrack	26	12.63
114 x 54	Racetrack	26	14.56
120 x 42	Racetrack	26	10.38
120 x 48	Racetrack	26	12.63
120 x 54	Racetrack	26	14.56
132 x 42	Racetrack	26	10.38
132 x 48	Racetrack	26	12.63
132 x 54	Racetrack	26	14.56
144 x 48	Racetrack	26	12.63
144 x 54	Racetrack	26	14.56
144 x 60	Racetrack	26	16.56

## RECTANGLE AND SOFT RECTANGLE TABLES WITH RACETRACK BASE

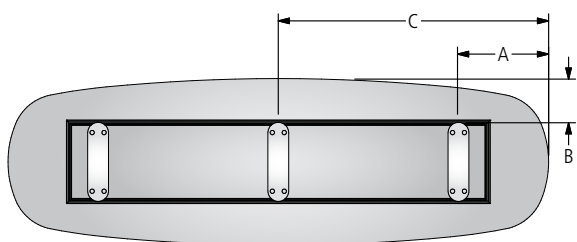
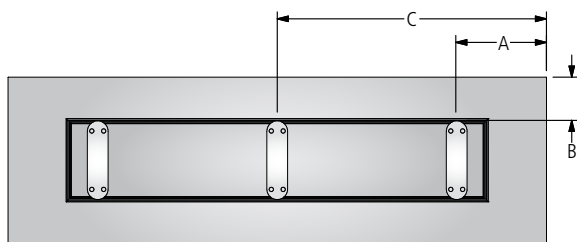

Table Size	Base	A (End)	B (Side)	C (Center)
156 x 48	Racetrack	26	12.63	78
156 x 54	Racetrack	26	14.56	78
156 x 60	Racetrack	26	16.56	78
168 x 54	Racetrack	26	14.56	84
168 x 60	Racetrack	26	16.56	84
180 x 54	Racetrack	26	14.56	90
180 x 60	Racetrack	26	16.56	90
192 x 54	Racetrack	26	14.56	96
192 x 60	Racetrack	26	16.56	96
204 x 54	Racetrack	26	14.56	102
204 x 60	Racetrack	26	16.56	102
216 x 54	Racetrack	26	14.56	108
216 x 60	Racetrack	26	16.56	108
228 x 54	Racetrack	26	14.56	114
228 x 60	Racetrack	26	16.56	114
240 x 54	Racetrack	26	14.56	120
240 x 60	Racetrack	26	16.56	120



## VENEER TOP WITH HARDWOOD EDGE



ROUND TOP



SQUARE TOP



SOFT SQUARE TOP

## BASE KEY

PC	Painted Cylinder
VY	Veneer Cylinder
OS	Open Frame Square
ML	Post Metal Leg

## ROUND TABLES

MODEL #	DIAMETER	SEATING CAPACITY	-PC	-VY	-OS	-ML
TFR-48-V	48	4	4,599	4,806	3,378	3,059
TFR-54-V	54	6	5,600	5,829	4,216	3,747
TFR-60-V	60	6	6,555	6,797	5,046	4,412

## SQUARE TABLES

MODEL #	LENGTH	WIDTH	SEATING CAPACITY	-OS	-ML
TFS-4848-V	48	48	4	3,378	3,059
TFS-5454-V	54	54	6	4,216	3,747
TFS-6060-V	60	60	6	5,046	4,412

## SOFT SQUARE TABLES

MODEL #	LENGTH	WIDTH	SEATING CAPACITY	-OS	-ML
TFQ-4848-V	48	48	4	3,378	3,059
TFQ-5454-V	54	54	6	4,216	3,747
TFQ-6060-V	60	60	6	5,046	4,412

## OPTIONS

## CODE

## PRICE

## NOTES

Power &amp; Data Options

See pages 121-131

## Polished Chrome Finish Options:

Polished Chrome Open Frame Square

Add -PCOS

\$1,118

Polished Chrome Post Metal Legs

Add -PCML-TWB

\$1,211

## EDGE PROFILE

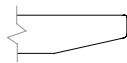

Two4Six Cutback Edge

## GENERAL INFORMATION

- Tops are 1-1/8"-thick with 3/16"-thick hardwood edge band
- Seating capacity based on 27" per person
- Overall table height 29.5"
- Standard with quarter cut veneer
- One section of wire management channel provided per table with Post Metal Leg and Open Frame Square Base

## REQUIRED INFORMATION (ORDER CANNOT BE ENTERED WITHOUT THIS INFORMATION)

See appendix pages vi-vii for surface material options.

- Choose Veneer Finish
- Choose Paint Finish, if -PC base is specified
- Choose Metal Finish only if -OS or -ML bases specified (Clear Anodized (-CA) is an option on the Post Metal Leg only)



## INSET LAMINATE TOP WITH HARDWOOD EDGE



ROUND TOP



SQUARE TOP



SOFT SQUARE TOP

## BASE KEY

PC	Painted Cylinder
VY	Veneer Cylinder
OS	Open Frame Square
ML	Post Metal Leg

## ROUND TABLES

MODEL #	DIAMETER	SEATING CAPACITY	-PC	-VY	-OS	-ML
TFR-48-P	48	4	4,345	4,540	3,192	2,890
TFR-54-P	54	6	5,291	5,507	3,983	3,540
TFR-60-P	60	6	6,192	6,421	4,767	4,168

## SQUARE TABLES

MODEL #	LENGTH	WIDTH	SEATING CAPACITY	-OS	-ML
TFS-4848-P	48	48	4	3,192	2,890
TFS-5454-P	54	54	6	3,983	3,540
TFS-6060-P	60	60	6	4,767	4,168

## SOFT SQUARE TABLES

MODEL #	LENGTH	WIDTH	SEATING CAPACITY	-OS	-ML
TFQ-4848-P	48	48	4	3,192	2,890
TFQ-5454-P	54	54	6	3,983	3,540
TFQ-6060-P	60	60	6	4,767	4,168

## OPTIONS

## CODE

## PRICE

## NOTES

Power &amp; Data Options

See pages 121-131

## Polished Chrome Finish Options:

Polished Chrome Open Frame Square

Add -PCOS

\$1,118

Polished Chrome Post Metal Legs

Add -PCML-TWB

\$1,211

## EDGE PROFILE

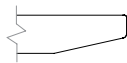

Two4Six Cutback Edge

## GENERAL INFORMATION

- Tops are 1-1/8"-thick with 3/16"-thick hardwood edge band
- Seating capacity based on 27" per person
- Overall table height 29.5"
- Standard with quarter cut veneer
- One section of wire management channel provided per table with Post Metal Leg and Open Frame Square Bases

## REQUIRED INFORMATION (ORDER CANNOT BE ENTERED WITHOUT THIS INFORMATION)

See appendix pages vi-vii for surface material options.

- Choose Laminate Finish
- Choose Wood Species & Finish
- Choose Paint Finish, if -PC base is specified
- Choose Veneer Finish, if -VY base is specified
- Choose Metal Finish, if -OS or -ML base is specified (Clear Anodized (-CA) is an option on the Post Metal Leg only)-





## LAMINATE TOP WITH ABS CUTBACK EDGE



ROUND TOP



SQUARE TOP



SOFT SQUARE TOP

## BASE KEY

PC	Painted Cylinder
VY	Veneer Cylinder
OS	Open Frame Square
ML	Post Metal Leg

## ROUND TABLES

MODEL #	DIAMETER	SEATING CAPACITY	-PC	-VY	-OS	-ML
TFR-48-PA	48	4	4,345	4,540	3,192	2,890
TFR-54-PA	54	6	5,291	5,507	3,983	3,540
TFR-60-PA	60	6	6,192	6,421	4,767	4,168

## SQUARE TABLES

MODEL #	LENGTH	WIDTH	SEATING CAPACITY	-OS	-ML
TFS-4848-PA	48	48	4	3,192	2,890
TFS-5454-PA	54	54	6	3,983	3,540
TFS-6060-PA	60	60	6	4,767	4,168

## SOFT SQUARE TABLES

MODEL #	LENGTH	WIDTH	SEATING CAPACITY	-OS	-ML
TFQ-4848-PA	48	48	4	3,192	2,890
TFQ-5454-PA	54	54	6	3,983	3,540
TFQ-6060-PA	60	60	6	4,767	4,168

## OPTIONS

## CODE

## PRICE

## NOTES

Power &amp; Data Options

See pages 121-131

## Polished Chrome Finish Options:

Polished Chrome Open Frame Square

Add -PCOS

\$1,118

Polished Chrome Post Metal Legs

Add -PCML-TWB

\$1,211

## EDGE PROFILE

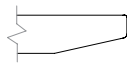

Two4Six Cutback Edge

## GENERAL INFORMATION

- Tops are 1-1/8" thick
- Seating capacity based on 27" per person
- Overall table height 29.5"
- Standard with quarter cut veneer
- One section of wire management channel provided per table with Post Metal Leg and Open Frame Square Bases

## REQUIRED INFORMATION (ORDER CANNOT BE ENTERED WITHOUT THIS INFORMATION)

See appendix pages vi-vii for surface material options.

- Choose Laminate Finish
- Choose ABS Edge Finish
- Choose Paint Finish, if -PC base is specified
- Choose Veneer Finish, if -VY base is specified
- Choose Metal Finish, if -OS or -ML base is specified (Clear Anodized (-CA) is an option on the Post Metal Leg only)



## LAMINATE TOP WITH ABS SQUARE EDGE



ROUND TOP



SQUARE TOP



SOFT SQUARE TOP

## BASE KEY

PC	Painted Cylinder
VY	Veneer Cylinder
OS	Open Frame Square
ML	Post Metal Leg

## ROUND TABLES

MODEL #	DIAMETER	SEATING CAPACITY	-PC	-VY	-OS	-ML
TFR-48-PE	48	4	4,090	4,274	3,005	2,721
TFR-54-PE	54	6	4,981	5,184	3,750	3,333
TFR-60-PE	60	6	5,830	6,045	4,488	3,924

## SQUARE TABLES

MODEL #	LENGTH	WIDTH	SEATING CAPACITY	-OS	-ML
TFS-4848-PE	48	48	4	2,471	2,224
TFS-5454-PE	54	54	6	2,919	2,581
TFS-6060-PE	60	60	6	3,471	3,021

## SOFT SQUARE TABLES

MODEL #	LENGTH	WIDTH	SEATING CAPACITY	-OS	-ML
TFQ-4848-PE	48	48	4	2,278	2,062
TFQ-5454-PE	54	54	6	2,686	2,387
TFQ-6060-PE	60	60	6	3,190	2,789

## OPTIONS

## CODE

## PRICE

## NOTES

Power &amp; Data Options

See pages 121-131

## Polished Chrome Finish Options:

Polished Chrome Open Frame Square

Add -PCOS

\$1,118

Polished Chrome Post Metal Legs

Add -PCML-TWB

\$1,211

## EDGE PROFILE



Two4Six Square Edge

## GENERAL INFORMATION

- Tops are 1-1/8" thick
- Seating capacity based on 27" per person
- Overall table height 29.5"
- Standard with quarter cut veneer
- One section of wire management channel provided per table with Post Metal Leg and Open Frame Square Bases

## REQUIRED INFORMATION (ORDER CANNOT BE ENTERED WITHOUT THIS INFORMATION)

See appendix pages vi-vii for surface material options.

- Choose Laminate Finish
- Choose ABS Edge Finish
- Choose Paint Finish, if -PC base is specified
- Choose Veneer Finish, if -VY base is specified
- Choose Metal Finish, if -OS or -ML base is specified (Clear Anodized (-CA) is an option on the Post Metal Leg only)



## GLASS TOP



ROUND TOP



SQUARE TOP



SOFT SQUARE TOP

## BASE KEY

PC	Painted Cylinder
VY	Veneer Cylinder
OS	Open Frame Square

## ROUND TABLES

MODEL #	DIAMETER	SEATING CAPACITY	-PC	-VY	-OS
TFR-48-G	48	4	8,440	8,819	6,200
TFR-54-G	54	6	10,278	10,697	7,737
TFR-60-G	60	6	12,030	12,474	9,261

## SQUARE TABLES

MODEL #	LENGTH	WIDTH	SEATING CAPACITY	-OS
TFS-4848-G	48	48	4	6,200
TFS-5454-G	54	54	6	7,737
TFS-6060-G	60	60	6	9,261

## SOFT SQUARE TABLES

MODEL #	LENGTH	WIDTH	SEATING CAPACITY	-OS
TFQ-4848-G	48	48	4	6,200
TFQ-5454-G	54	54	6	7,737
TFQ-6060-G	60	60	6	9,261

## OPTIONS

## CODE

## PRICE

## NOTES

Power &amp; Data Options

See pages 121-131

## Polished Chrome Finish Options:

Polished Chrome Open Frame Square

Add -PCOS

\$1,118

Polished Chrome Post Metal Legs

Add -PCML-TWB

\$1,211

## EDGE PROFILE



Two4Six Glass Edge

## GENERAL INFORMATION

- Tops are 1-1/8" -thick with 3/16" -thick hardwood edge band
- Seating capacity based on 27" per person
- Overall table height 29.5"
- Standard with quarter cut veneer
- One section of wire management channel provided per table with Post Metal Leg and Open Frame Square Bases

## REQUIRED INFORMATION (ORDER CANNOT BE ENTERED WITHOUT THIS INFORMATION)

See appendix pages vi-vii for surface material options.

- Choose Glass Finish
- Choose Veneer Finish, if applicable
- Choose Metal Finish, if applicable
- Choose Paint Finish, if applicable
- Choose Sub-Top Finish: Paint Finish or Wood Species & Finish



# SOLID SURFACE TOP



ROUND TOP



SQUARE TOP



SOFT SQUARE TOP

**BASE KEY**

- PC Painted Cylinder
- VY Veneer Cylinder
- OS Open Frame Square

**ROUND TABLES**

MODEL #	DIAMETER	SEATING CAPACITY	-PC	-VY	-OS
TFR-48-SS	48	4	8,819	9,215	6,478
TFR-54-SS	54	6	10,739	11,177	8,084
TFR-60-SS	60	6	12,569	13,034	9,676

**SQUARE TABLES**

MODEL #	LENGTH	WIDTH	SEATING CAPACITY	-OS
TFS-4848-SS	48	48	4	6,478
TFS-5454-SS	54	54	6	8,084
TFS-6060-SS	60	60	6	9,676

**SOFT SQUARE TABLES**

MODEL #	LENGTH	WIDTH	SEATING CAPACITY	-OS
TFQ-4848-SS	48	48	4	6,478
TFQ-5454-SS	54	54	6	8,084
TFQ-6060-SS	60	60	6	9,676

**OPTIONS**

OPTIONS	CODE	PRICE	NOTES
Power & Data Options			See pages 121-131
<b>Polished Chrome Finish Options:</b>			
Polished Chrome Open Frame Square	Add -PCOS	\$1,118	

**EDGE PROFILE**

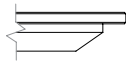

Two4Six Solid Surface Edge

**GENERAL INFORMATION**

- Seating capacity based on 27" per person
- Overall table height 29.5"
- Standard with quarter cut veneer
- One section of wire management channel provided per table with Post Metal Leg and Open Frame Square Bases

**REQUIRED INFORMATION (ORDER CANNOT BE ENTERED WITHOUT THIS INFORMATION)**

See appendix pages vi-vii for surface material options.

- Choose Solid Surface Finish
- Choose Veneer Finish, if applicable
- Choose Metal Finish, if applicable
- Choose Paint Finish, if applicable



## STONE / QUARTZ TOP



ROUND TOP



SQUARE TOP



SOFT SQUARE TOP

## BASE KEY

PC	Painted Cylinder
VY	Veneer Cylinder
OS	Open Frame Square

## ROUND TABLES

MODEL #	DIAMETER	SEATING CAPACITY	-PC	-VY	-OS
TFR-48-S	48	4	10,442	10,911	7,670
TFR-54-S	54	6	12,715	13,235	9,571

## SQUARE TABLES

MODEL #	LENGTH	WIDTH	SEATING CAPACITY	-OS
TFS-4848-S	48	48	4	7,670
TFS-5454-S	54	54	6	9,571

## SOFT SQUARE TABLES

MODEL #	LENGTH	WIDTH	SEATING CAPACITY	-OS
TFQ-4848-S	48	48	4	7,670
TFQ-5454-S	54	54	6	9,571

## OPTIONS

## CODE

## PRICE

## NOTES

Power &amp; Data Options

See pages 121-131

## Polished Chrome Finish Options:

Polished Chrome Open Frame Square

Add -PCOS

\$1,118

## EDGE PROFILE

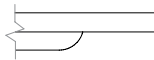

Two4Six Stone / Quartz Edge

## GENERAL INFORMATION

- Seating capacity based on 27" per person
- Overall table height 29.5"
- One section of wire management channel provided per table with Post Metal Leg and Open Frame Square Bases

## REQUIRED INFORMATION (ORDER CANNOT BE ENTERED WITHOUT THIS INFORMATION)

See appendix pages vi-vii for surface material options.

- Choose Stone/Quartz Finish
- Choose Veneer Finish, if applicable
- Choose Metal Finish
- Choose Paint Finish, if applicable



# VENEER TOP WITH HARDWOOD EDGE



RECTANGLE TOP

**BASE KEY**

- OF Open Frame
- OFX Open Frame with X Center Base
- OFRP Open Frame with Painted Rectangle Center Base
- OFRV Open Frame with Veneer Rectangle Center Base
- RCL Laminate Racetrack Base
- RCP Painted Racetrack Base
- RCV Veneer Racetrack Base
- ML Post Metal Leg
- MLX Post Metal Leg with X Center Base
- MLRP Post Metal Leg with Painted Rectangle Center Base
- MLRV Post Metal Leg with Veneer Rectangle Center Base

**RECTANGLE TABLES**

MODEL #	L x W	BASE QTY	TOP SECTIONS	SEATING CAPACITY	-OF	-OFX	-OFRP	-OFRV	-RCL	-RCP	-RCV	-ML	-MLX	-MLRP	-MLRV
TFT-6030-V	60 x 30	2	1	4	3,943	-	-	-	-	-	-	2,946	-	-	-
TFT-6036-V	60 x 36	2	1	4	4,147	-	-	-	-	-	-	3,101	-	-	-
TFT-6042-V	60 x 42	2	1	4	4,731	-	-	-	-	-	-	3,540	-	-	-
TFT-6048-V	60 x 48	2	1	4	5,123	-	-	-	-	-	-	3,836	-	-	-
TFT-6630-V	66 x 30	2	1	4	4,298	-	-	-	-	-	-	3,219	-	-	-
TFT-6636-V	66 x 36	2	1	4	4,535	-	-	-	-	-	-	3,399	-	-	-
TFT-6642-V	66 x 42	2	1	4	5,188	-	-	-	-	-	-	3,892	-	-	-
TFT-6648-V	66 x 48	2	1	4	5,633	-	-	-	-	-	-	4,228	-	-	-
TFT-7230-V	72 x 30	2	1	6	4,433	-	-	-	-	-	-	3,328	-	-	-
TFT-7236-V	72 x 36	2	1	6	4,691	-	-	-	-	-	-	3,524	-	-	-
TFT-7242-V	72 x 42	2	1	6	5,382	-	-	-	5,382	5,645	5,901	4,046	-	-	-
TFT-7248-V	72 x 48	2	1	6	5,857	-	-	-	5,857	6,129	6,395	4,406	-	-	-
TFT-7830-V	78 x 30	2	1	6	4,885	-	-	-	-	-	-	3,676	-	-	-
TFT-7836-V	78 x 36	2	1	6	5,184	-	-	-	-	-	-	3,903	-	-	-
TFT-7842-V	78 x 42	2	1	6	5,961	-	-	-	5,961	6,243	6,517	4,491	-	-	-
TFT-7848-V	78 x 48	2	1	6	6,504	-	-	-	6,504	6,795	7,079	4,902	-	-	-
TFT-8430-V	84 x 30	2	1	8	5,029	-	-	-	-	-	-	3,792	-	-	-
TFT-8436-V	84 x 36	2	1	8	5,351	-	-	-	-	-	-	4,037	-	-	-
TFT-8442-V	84 x 42	2	1	8	6,168	-	-	-	6,168	6,450	6,724	4,656	-	-	-
TFT-8448-V	84 x 48	2	1	8	6,744	-	-	-	6,744	7,035	7,319	5,093	-	-	-
TFT-9030-V	90 x 30	2	1	8	5,442	-	-	-	-	-	-	4,113	-	-	-
TFT-9036-V	90 x 36	2	1	8	5,805	-	-	-	-	-	-	4,388	-	-	-
TFT-9042-V	90 x 42	2	1	8	6,706	-	-	-	6,706	7,002	7,291	5,072	-	-	-
TFT-9048-V	90 x 48	2	1	8	7,346	-	-	-	7,346	7,652	7,951	5,557	-	-	-
TFT-9630-V	96 x 30	2	1	8	5,593	-	-	-	-	-	-	4,234	-	-	-
TFT-9636-V	96 x 36	2	1	8	5,980	-	-	-	-	-	-	4,529	-	-	-
TFT-9642-V	96 x 42	2	1	8	6,924	-	-	-	6,924	7,220	7,509	5,246	-	-	-
TFT-9648-V	96 x 48	2	1	8	7,598	-	-	-	7,598	7,904	8,203	5,757	-	-	-
TFT-10242-V	102 x 42	2	1	8	7,539	-	-	-	7,539	7,851	8,156	5,720	-	-	-
TFT-10248-V	102 x 48	2	1	8	8,286	-	-	-	8,286	8,609	8,925	6,288	-	-	-
TFT-10842-V	108 x 42	2	1	10	7,768	-	-	-	7,768	8,080	8,385	5,903	-	-	-
TFT-10848-V	108 x 48	2	1	10	8,553	-	-	-	8,553	8,876	9,191	6,500	-	-	-
TFT-10854-V	108 x 54	2	1	10	9,472	-	-	-	9,472	9,810	10,139	7,199	-	-	-
TFT-11442-V	114 x 42	2	1	10	8,419	-	-	-	8,419	8,747	9,068	6,406	-	-	-
TFT-11448-V	114 x 48	2	1	10	9,283	-	-	-	9,283	9,623	9,955	7,064	-	-	-
TFT-11454-V	114 x 54	2	1	12	10,295	-	-	-	10,295	10,651	10,997	7,834	-	-	-
TFT-12042-V	120 x 42	2	1	10	8,660	-	-	-	8,660	8,989	9,310	6,600	-	-	-
TFT-12048-V	120 x 48	2	1	10	9,563	-	-	-	9,563	9,904	10,236	7,286	-	-	-
TFT-12054-V	120 x 54	2	1	12	10,619	-	-	-	10,619	10,975	11,322	8,090	-	-	-
TFT-13242-V	132 x 42	2	2	10	9,525	-	-	-	9,525	9,867	10,202	7,276	-	-	-
TFT-13248-V	132 x 48	2	2	10	10,546	-	-	-	10,546	10,900	11,246	8,053	-	-	-
TFT-13254-V	132 x 54	2	2	12	11,737	-	-	-	11,737	12,108	12,469	8,962	-	-	-
TFT-14448-V	144 x 48	2	2	12	11,574	-	-	-	11,574	11,943	12,303	8,857	-	-	-
TFT-14454-V	144 x 54	2	2	14	12,909	-	-	-	12,909	13,294	13,670	9,876	-	-	-
TFT-14460-V	144 x 60	2	2	14	14,460	-	-	-	14,460	14,866	15,262	11,058	-	-	-
TFT-15648-V	156 x 48	3	2	14	-	14,754	14,754	14,754	14,754	15,312	15,857	-	11,310	11,310	11,310
TFT-15654-V	156 x 54	3	2	14	-	16,307	16,307	16,307	16,307	16,890	17,459	-	12,496	12,496	12,496
TFT-15660-V	156 x 60	3	2	14	-	18,119	18,119	18,119	18,119	18,734	19,333	-	13,880	13,880	13,880
TFT-16854-V	168 x 54	3	2	16	-	17,105	17,105	17,105	17,105	17,688	18,258	-	13,145	13,145	13,145
TFT-16860-V	168 x 60	3	2	16	-	19,033	19,033	19,033	19,033	19,647	20,247	-	14,619	14,619	14,619
TFT-18054-V	180 x 54	3	2	16	-	17,902	17,902	17,902	17,902	18,485	19,055	-	13,795	13,795	13,795
TFT-18060-V	180 x 60	3	2	16	-	19,946	19,946	19,946	19,946	20,560	21,160	-	15,358	15,358	15,358
TFT-19254-V	192 x 54	3	2	18	-	18,700	18,700	18,700	18,700	19,284	19,853	-	14,444	14,444	14,444
TFT-19260-V	192 x 60	3	2	18	-	20,859	20,859	20,859	20,859	21,474	22,074	-	16,098	16,098	16,098
TFT-20454-V	204 x 54	3	2	18	-	20,291	20,291	20,291	20,291	20,898	21,490	-	15,706	15,706	15,706
TFT-20460-V	204 x 60	3	2	18	-	22,657	22,657	22,657	22,657	23,296	23,920	-	17,520	17,520	17,520
TFT-21654-V	216 x 54	3	2	20	-	21,635	21,635	21,635	21,635	22,257	22,864	-	16,780	16,780	16,780
TFT-21660-V	216 x 60	3	2	20	-	24,182	24,182	24,182	24,182	24,837	25,476	-	18,735	18,735	18,735
TFT-22854-V	228 x 54	3	2	20	-	22,701	22,701	22,701	22,701	23,329	23,941	-	17,640	17,640	17,640
TFT-22860-V	228 x 60	3	2	20	-	25,396	25,396	25,396	25,396	26,057	26,702	-	19,709	19,709	19,709
TFT-24054-V	240 x 54	3	2	20	-	23,826	23,826	23,826	23,826	24,461	25,080	-	18,546	18,546	18,546
TFT-24060-V	240 x 60	3	2	20	-	26,677	26,677	26,677	26,677	27,346	27,998	-	20,736	20,736	20,736



# VENEER TOP WITH HARDWOOD EDGE

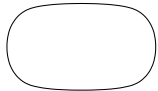

SOFT RECTANGLE TOP

**BASE KEY**

- OF Open Frame
- OFX Open Frame with X Center Base
- OFRP Open Frame with Painted Rectangle Center Base
- OFRV Open Frame with Veneer Rectangle Center Base

- RCL Laminate Racetrack Base
- RCP Painted Racetrack Base
- RCV Veneer Racetrack Base

- ML Post Metal Leg
- MLX Post Metal Leg with X Center Base
- MLRP Post Metal Leg with Painted Rectangle Center Base
- MLRV Post Metal Leg with Veneer Rectangle Center Base

**SOFT RECTANGLE TABLES**

MODEL #	L x W	BASE QTY	TOP SECTIONS	SEATING CAPACITY	-OF	-OFX	-OFRP	-OFRV	-RCL	-RCP	-RCV	-ML	-MLX	-MLRP	-MLRV
TFF-6030-V	60 x 30	2	1	4	3,943	-	-	-	-	-	-	2,946	-	-	-
TFF-6036-V	60 x 36	2	1	4	4,147	-	-	-	-	-	-	3,101	-	-	-
TFF-6042-V	60 x 42	2	1	4	4,731	-	-	-	-	-	-	3,540	-	-	-
TFF-6048-V	60 x 48	2	1	4	5,123	-	-	-	-	-	-	3,836	-	-	-
TFF-6630-V	66 x 30	2	1	4	4,298	-	-	-	-	-	-	3,219	-	-	-
TFF-6636-V	66 x 36	2	1	4	4,535	-	-	-	-	-	-	3,399	-	-	-
TFF-6642-V	66 x 42	2	1	4	5,188	-	-	-	-	-	-	3,892	-	-	-
TFF-6648-V	66 x 48	2	1	4	5,633	-	-	-	-	-	-	4,228	-	-	-
TFF-7230-V	72 x 30	2	1	6	4,433	-	-	-	-	-	-	3,328	-	-	-
TFF-7236-V	72 x 36	2	1	6	4,691	-	-	-	-	-	-	3,524	-	-	-
TFF-7242-V	72 x 42	2	1	6	5,382	-	-	-	5,382	5,645	5,901	4,046	-	-	-
TFF-7248-V	72 x 48	2	1	6	5,857	-	-	-	5,857	6,129	6,395	4,406	-	-	-
TFF-7830-V	78 x 30	2	1	6	4,885	-	-	-	-	-	-	3,676	-	-	-
TFF-7836-V	78 x 36	2	1	6	5,184	-	-	-	-	-	-	3,903	-	-	-
TFF-7842-V	78 x 42	2	1	6	5,961	-	-	-	5,961	6,243	6,517	4,491	-	-	-
TFF-7848-V	78 x 48	2	1	6	6,504	-	-	-	6,504	6,795	7,079	4,902	-	-	-
TFF-8430-V	84 x 30	2	1	8	5,029	-	-	-	-	-	-	3,792	-	-	-
TFF-8436-V	84 x 36	2	1	8	5,351	-	-	-	-	-	-	4,037	-	-	-
TFF-8442-V	84 x 42	2	1	8	6,168	-	-	-	6,168	6,450	6,724	4,656	-	-	-
TFF-8448-V	84 x 48	2	1	8	6,744	-	-	-	6,744	7,035	7,319	5,093	-	-	-
TFF-9030-V	90 x 30	2	1	8	5,442	-	-	-	-	-	-	4,113	-	-	-
TFF-9036-V	90 x 36	2	1	8	5,805	-	-	-	-	-	-	4,388	-	-	-
TFF-9042-V	90 x 42	2	1	8	6,706	-	-	-	6,706	7,002	7,291	5,072	-	-	-
TFF-9048-V	90 x 48	2	1	8	7,346	-	-	-	7,346	7,652	7,951	5,557	-	-	-
TFF-9630-V	96 x 30	2	1	8	5,593	-	-	-	-	-	-	4,234	-	-	-
TFF-9636-V	96 x 36	2	1	8	5,980	-	-	-	-	-	-	4,529	-	-	-
TFF-9642-V	96 x 42	2	1	8	6,924	-	-	-	6,924	7,220	7,509	5,246	-	-	-
TFF-9648-V	96 x 48	2	1	8	7,598	-	-	-	7,598	7,904	8,203	5,757	-	-	-
TFF-10242-V	102 x 42	2	1	8	7,539	-	-	-	7,539	7,851	8,156	5,720	-	-	-
TFF-10248-V	102 x 48	2	1	8	8,286	-	-	-	8,286	8,609	8,925	6,288	-	-	-
TFF-10842-V	108 x 42	2	1	10	7,768	-	-	-	7,768	8,080	8,385	5,903	-	-	-
TFF-10848-V	108 x 48	2	1	10	8,553	-	-	-	8,553	8,876	9,191	6,500	-	-	-
TFF-10854-V	108 x 54	2	1	10	9,472	-	-	-	9,472	9,810	10,139	7,199	-	-	-
TFF-11442-V	114 x 42	2	1	10	8,419	-	-	-	8,419	8,747	9,068	6,406	-	-	-
TFF-11448-V	114 x 48	2	1	10	9,283	-	-	-	9,283	9,623	9,955	7,064	-	-	-
TFF-11454-V	114 x 54	2	1	12	10,295	-	-	-	10,295	10,651	10,997	7,834	-	-	-
TFF-12042-V	120 x 42	2	1	10	8,660	-	-	-	8,660	8,989	9,310	6,600	-	-	-
TFF-12048-V	120 x 48	2	1	10	9,563	-	-	-	9,563	9,904	10,236	7,286	-	-	-
TFF-12054-V	120 x 54	2	1	12	10,619	-	-	-	10,619	10,975	11,322	8,090	-	-	-
TFF-13242-V	132 x 42	2	2	10	9,525	-	-	-	9,525	9,867	10,202	7,276	-	-	-
TFF-13248-V	132 x 48	2	2	10	10,546	-	-	-	10,546	10,900	11,246	8,053	-	-	-
TFF-13254-V	132 x 54	2	2	12	11,737	-	-	-	11,737	12,108	12,469	8,962	-	-	-
TFF-14448-V	144 x 48	2	2	12	11,574	-	-	-	11,574	11,943	12,303	8,857	-	-	-
TFF-14454-V	144 x 54	2	2	14	12,909	-	-	-	12,909	13,294	13,670	9,876	-	-	-
TFF-14460-V	144 x 60	2	2	14	14,460	-	-	-	14,460	14,866	15,262	11,058	-	-	-
TFF-15648-V	156 x 48	3	2	14	-	14,754	14,754	14,754	14,754	15,312	15,857	-	11,310	11,310	11,310
TFF-15654-V	156 x 54	3	2	14	-	16,307	16,307	16,307	16,307	16,890	17,459	-	12,496	12,496	12,496
TFF-15660-V	156 x 60	3	2	14	-	18,119	18,119	18,119	18,119	18,734	19,333	-	13,880	13,880	13,880
TFF-16854-V	168 x 54	3	2	16	-	17,105	17,105	17,105	17,105	17,688	18,258	-	13,145	13,145	13,145
TFF-16860-V	168 x 60	3	2	16	-	19,033	19,033	19,033	19,033	19,647	20,247	-	14,619	14,619	14,619
TFF-18054-V	180 x 54	3	2	16	-	17,902	17,902	17,902	17,902	18,485	19,055	-	13,795	13,795	13,795
TFF-18060-V	180 x 60	3	2	16	-	19,946	19,946	19,946	19,946	20,560	21,160	-	15,358	15,358	15,358
TFF-19254-V	192 x 54	3	2	18	-	18,700	18,700	18,700	18,700	19,284	19,853	-	14,444	14,444	14,444
TFF-19260-V	192 x 60	3	2	18	-	20,859	20,859	20,859	20,859	21,474	22,074	-	16,098	16,098	16,098
TFF-20454-V	204 x 54	3	2	18	-	20,291	20,291	20,291	20,291	20,898	21,490	-	15,706	15,706	15,706
TFF-20460-V	204 x 60	3	2	18	-	22,657	22,657	22,657	22,657	23,296	23,920	-	17,520	17,520	17,520
TFF-21654-V	216 x 54	3	2	20	-	21,635	21,635	21,635	21,635	22,257	22,864	-	16,780	16,780	16,780
TFF-21660-V	216 x 60	3	2	20	-	24,182	24,182	24,182	24,182	24,837	25,476	-	18,735	18,735	18,735
TFF-22854-V	228 x 54	3	2	20	-	22,701	22,701	22,701	22,701	23,329	23,941	-	17,640	17,640	17,640
TFF-22860-V	228 x 60	3	2	20	-	25,396	25,396	25,396	25,396	26,057	26,702	-	19,709	19,709	19,709
TFF-24054-V	240 x 54	3	2	20	-	23,826	23,826	23,826	23,826	24,461	25,080	-	18,546	18,546	18,546
TFF-24060-V	240 x 60	3	2	20	-	26,677	26,677	26,677	26,677	27,346	27,998	-	20,736	20,736	20,736



# VENEER TOP WITH HARDWOOD EDGE

OPTIONS	CODE	PRICE	NOTES
Power & Data Options			See pages 121-131
<b>Polished Chrome Finish Options:</b>			
Polished Chrome Open Frame Base	Add -PCOF-TWB	\$2,256	
Polished Chrome Post Metal Legs	Add -PCML-TWB	\$1,211	
Polished Chrome Open Frame with X-Center Base	Add -PCOFX-TWB	\$3,383	
Polished Chrome Post Metal Legs with X-Center Base	Add -PCMLX-TWB	\$2,337	
<b>Multi-Section Tops:</b>			
102", 108", 114" and 120" one-piece tops split into two sections	Specify -2	\$795	Note: Power Matrix (center of table location only) cannot be specified when this option is selected
204", 216", 228" or 240" two-piece tops split into four sections	Specify -4	\$1,585	

## EDGE PROFILE

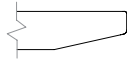

Two4Six Cutback Edge

## GENERAL INFORMATION

- Tops are 1-1/8"-thick with 3/16"-thick hardwood edge band
- Seating capacity based on 27" per person
- Overall table height 29.5"
- Standard with quarter cut veneer
- One section of wire management channel provided per table with Post Metal Leg and Open Frame Square Bases
- Racetrack Bases have a removable access door

### REQUIRED INFORMATION (ORDER CANNOT BE ENTERED WITHOUT THIS INFORMATION)

See appendix pages vi-vii for surface material options.

- Choose Veneer Finish
- Choose Metal Finish only if -OF or -ML bases specified (Clear Anodized (-CA) is an option on the Post Metal Leg only)
- Choose ABS Finish or Coordinating Woodgrain Edgeband finish if -RCL base specified
- Choose Beam Metal Finish for tables 102"-240"L, with a Racetrack Base (-RCL, -RCP, -RCV)





# INSET LAMINATE TOP WITH HARDWOOD EDGE



RECTANGLE TOP

**BASE KEY**

- OF Open Frame
- OFX Open Frame with X Center Base
- OFRP Open Frame with Painted Rectangle Center Base
- OFRV Open Frame with Veneer Rectangle Center Base
- RCL Laminate Racetrack Base
- RCP Painted Racetrack Base
- RCV Veneer Racetrack Base
- ML Post Metal Leg
- MLX Post Metal Leg with X Center Base
- MLRP Post Metal Leg with Painted Rectangle Center Base
- MLRV Post Metal Leg with Veneer Rectangle Center Base

**RECTANGLE TABLES**

MODEL #	L x W	BASE QTY	TOP SECTIONS	SEATING CAPACITY	-OF	-OFX	-OFRP	-OFRV	-RCL	-RCP	-RCV	-ML	-MLX	-MLRP	-MLRV
TFT-6030-P	60 x 30	2	1	4	3,727	-	-	-	-	-	-	2,784	-	-	-
TFT-6036-P	60 x 36	2	1	4	3,919	-	-	-	-	-	-	2,931	-	-	-
TFT-6042-P	60 x 42	2	1	4	4,471	-	-	-	-	-	-	3,346	-	-	-
TFT-6048-P	60 x 48	2	1	4	4,842	-	-	-	-	-	-	3,626	-	-	-
TFT-6630-P	66 x 30	2	1	4	4,062	-	-	-	-	-	-	3,042	-	-	-
TFT-6636-P	66 x 36	2	1	4	4,286	-	-	-	-	-	-	3,213	-	-	-
TFT-6642-P	66 x 42	2	1	4	4,903	-	-	-	-	-	-	3,678	-	-	-
TFT-6648-P	66 x 48	2	1	4	5,324	-	-	-	-	-	-	3,996	-	-	-
TFT-7230-P	72 x 30	2	1	6	4,190	-	-	-	-	-	-	3,145	-	-	-
TFT-7236-P	72 x 36	2	1	6	4,433	-	-	-	-	-	-	3,331	-	-	-
TFT-7242-P	72 x 42	2	1	6	5,086	-	-	-	5,086	5,335	5,577	3,824	-	-	-
TFT-7248-P	72 x 48	2	1	6	5,535	-	-	-	5,535	5,792	6,044	4,164	-	-	-
TFT-7830-P	78 x 30	2	1	6	4,617	-	-	-	-	-	-	3,474	-	-	-
TFT-7836-P	78 x 36	2	1	6	4,899	-	-	-	-	-	-	3,689	-	-	-
TFT-7842-P	78 x 42	2	1	6	5,634	-	-	-	5,634	5,900	6,159	4,244	-	-	-
TFT-7848-P	78 x 48	2	1	6	6,147	-	-	-	6,147	6,422	6,690	4,633	-	-	-
TFT-8430-P	84 x 30	2	1	8	4,753	-	-	-	-	-	-	3,584	-	-	-
TFT-8436-P	84 x 36	2	1	8	5,057	-	-	-	-	-	-	3,815	-	-	-
TFT-8442-P	84 x 42	2	1	8	5,829	-	-	-	5,829	6,096	6,355	4,400	-	-	-
TFT-8448-P	84 x 48	2	1	8	6,374	-	-	-	6,374	6,649	6,917	4,813	-	-	-
TFT-9030-P	90 x 30	2	1	8	5,143	-	-	-	-	-	-	3,887	-	-	-
TFT-9036-P	90 x 36	2	1	8	5,486	-	-	-	-	-	-	4,147	-	-	-
TFT-9042-P	90 x 42	2	1	8	6,338	-	-	-	6,338	6,617	6,890	4,794	-	-	-
TFT-9048-P	90 x 48	2	1	8	6,942	-	-	-	6,942	7,232	7,514	5,252	-	-	-
TFT-9630-P	96 x 30	2	1	8	5,286	-	-	-	-	-	-	4,002	-	-	-
TFT-9636-P	96 x 36	2	1	8	5,652	-	-	-	-	-	-	4,280	-	-	-
TFT-9642-P	96 x 42	2	1	8	6,544	-	-	-	6,544	6,823	7,097	4,958	-	-	-
TFT-9648-P	96 x 48	2	1	8	7,181	-	-	-	7,181	7,470	7,752	5,441	-	-	-
TFT-10242-P	102 x 42	2	1	8	7,125	-	-	-	7,125	7,420	7,708	5,406	-	-	-
TFT-10248-P	102 x 48	2	1	8	7,831	-	-	-	7,831	8,136	8,435	5,943	-	-	-
TFT-10842-P	108 x 42	2	1	10	7,341	-	-	-	7,341	7,636	7,924	5,579	-	-	-
TFT-10848-P	108 x 48	2	1	10	8,083	-	-	-	8,083	8,388	8,686	6,143	-	-	-
TFT-10854-P	108 x 54	2	1	10	8,952	-	-	-	8,952	9,271	9,582	6,804	-	-	-
TFT-11442-P	114 x 42	2	1	10	7,956	-	-	-	7,956	8,266	8,570	6,054	-	-	-
TFT-11448-P	114 x 48	2	1	10	8,773	-	-	-	8,773	9,094	9,408	6,676	-	-	-
TFT-11454-P	114 x 54	2	1	12	9,729	-	-	-	9,729	10,066	10,393	7,404	-	-	-
TFT-12042-P	120 x 42	2	1	10	8,184	-	-	-	8,184	8,495	8,798	6,237	-	-	-
TFT-12048-P	120 x 48	2	1	10	9,038	-	-	-	9,038	9,360	9,674	6,886	-	-	-
TFT-12054-P	120 x 54	2	1	12	10,035	-	-	-	10,035	10,372	10,700	7,646	-	-	-
TFT-13242-P	132 x 42	2	2	10	9,002	-	-	-	9,002	9,325	9,641	6,876	-	-	-
TFT-13248-P	132 x 48	2	2	10	9,966	-	-	-	9,966	10,301	10,628	7,611	-	-	-
TFT-13254-P	132 x 54	2	2	12	11,092	-	-	-	11,092	11,443	11,784	8,470	-	-	-
TFT-14448-P	144 x 48	2	2	12	10,938	-	-	-	10,938	11,287	11,627	8,370	-	-	-
TFT-14454-P	144 x 54	2	2	14	12,200	-	-	-	12,200	12,563	12,919	9,333	-	-	-
TFT-14460-P	144 x 60	2	2	14	13,665	-	-	-	13,665	14,049	14,423	10,450	-	-	-
TFT-15648-P	156 x 48	3	2	14	-	13,943	13,943	13,943	13,943	14,470	14,985	-	10,688	10,688	10,688
TFT-15654-P	156 x 54	3	2	14	-	15,411	15,411	15,411	15,411	15,962	16,499	-	11,809	11,809	11,809
TFT-15660-P	156 x 60	3	2	14	-	17,123	17,123	17,123	17,123	17,704	18,270	-	13,117	13,117	13,117
TFT-16854-P	168 x 54	3	2	16	-	16,165	16,165	16,165	16,165	16,716	17,254	-	12,423	12,423	12,423
TFT-16860-P	168 x 60	3	2	16	-	17,987	17,987	17,987	17,987	18,567	19,134	-	13,815	13,815	13,815
TFT-18054-P	180 x 54	3	2	16	-	16,918	16,918	16,918	16,918	17,469	18,007	-	13,037	13,037	13,037
TFT-18060-P	180 x 60	3	2	16	-	18,849	18,849	18,849	18,849	19,430	19,997	-	14,514	14,514	14,514
TFT-19254-P	192 x 54	3	2	18	-	17,672	17,672	17,672	17,672	18,224	18,762	-	13,650	13,650	13,650
TFT-19260-P	192 x 60	3	2	18	-	19,712	19,712	19,712	19,712	20,293	20,860	-	15,213	15,213	15,213
TFT-20454-P	204 x 54	3	2	18	-	19,175	19,175	19,175	19,175	19,749	20,309	-	14,843	14,843	14,843
TFT-20460-P	204 x 60	3	2	18	-	21,411	21,411	21,411	21,411	22,015	22,605	-	16,557	16,557	16,557
TFT-21654-P	216 x 54	3	2	20	-	20,446	20,446	20,446	20,446	21,033	21,607	-	15,858	15,858	15,858
TFT-21660-P	216 x 60	3	2	20	-	22,852	22,852	22,852	22,852	23,471	24,075	-	17,705	17,705	17,705
TFT-22854-P	228 x 54	3	2	20	-	21,453	21,453	21,453	21,453	22,046	22,625	-	16,670	16,670	16,670
TFT-22860-P	228 x 60	3	2	20	-	24,000	24,000	24,000	24,000	24,624	25,234	-	18,626	18,626	18,626
TFT-24054-P	240 x 54	3	2	20	-	22,516	22,516	22,516	22,516	23,116	23,701	-	17,526	17,526	17,526
TFT-24060-P	240 x 60	3	2	20	-	25,210	25,210	25,210	25,210	25,842	26,459	-	19,596	19,596	19,596



# INSET LAMINATE TOP WITH HARDWOOD EDGE

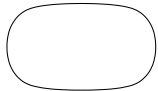

SOFT RECTANGLE TOP

**BASE KEY**

- OF Open Frame
- OFX Open Frame with X Center Base
- OFRP Open Frame with Painted Rectangle Center Base
- OFRV Open Frame with Veneer Rectangle Center Base
- RCL Laminate Racetrack Base
- RCP Painted Racetrack Base
- RCV Veneer Racetrack Base
- ML Post Metal Leg
- MLX Post Metal Leg with X Center Base
- MLRP Post Metal Leg with Painted Rectangle Center Base
- MLRV Post Metal Leg with Veneer Rectangle Center Base

**SOFT RECTANGLE TABLES**

MODEL #	L x W	BASE QTY	TOP SECTIONS	SEATING CAPACITY	-OF	-OFX	-OFRP	-OFRV	-RCL	-RCP	-RCV	-ML	-MLX	-MLRP	-MLRV
TFF-6030-P	60 x 30	2	1	4	3,727	-	-	-	-	-	-	2,784	-	-	-
TFF-6036-P	60 x 36	2	1	4	3,919	-	-	-	-	-	-	2,931	-	-	-
TFF-6042-P	60 x 42	2	1	4	4,471	-	-	-	-	-	-	3,346	-	-	-
TFF-6048-P	60 x 48	2	1	4	4,842	-	-	-	-	-	-	3,626	-	-	-
TFF-6630-P	66 x 30	2	1	4	4,062	-	-	-	-	-	-	3,042	-	-	-
TFF-6636-P	66 x 36	2	1	4	4,286	-	-	-	-	-	-	3,213	-	-	-
TFF-6642-P	66 x 42	2	1	4	4,903	-	-	-	-	-	-	3,678	-	-	-
TFF-6648-P	66 x 48	2	1	4	5,324	-	-	-	-	-	-	3,996	-	-	-
TFF-7230-P	72 x 30	2	1	6	4,190	-	-	-	-	-	-	3,145	-	-	-
TFF-7236-P	72 x 36	2	1	6	4,433	-	-	-	-	-	-	3,331	-	-	-
TFF-7242-P	72 x 42	2	1	6	5,086	-	-	-	5,086	5,335	5,577	3,824	-	-	-
TFF-7248-P	72 x 48	2	1	6	5,535	-	-	-	5,535	5,792	6,044	4,164	-	-	-
TFF-7830-P	78 x 30	2	1	6	4,617	-	-	-	-	-	-	3,474	-	-	-
TFF-7836-P	78 x 36	2	1	6	4,899	-	-	-	-	-	-	3,689	-	-	-
TFF-7842-P	78 x 42	2	1	6	5,634	-	-	-	5,634	5,900	6,159	4,244	-	-	-
TFF-7848-P	78 x 48	2	1	6	6,147	-	-	-	6,147	6,422	6,690	4,633	-	-	-
TFF-8430-P	84 x 30	2	1	8	4,753	-	-	-	-	-	-	3,584	-	-	-
TFF-8436-P	84 x 36	2	1	8	5,057	-	-	-	-	-	-	3,815	-	-	-
TFF-8442-P	84 x 42	2	1	8	5,829	-	-	-	5,829	6,096	6,355	4,400	-	-	-
TFF-8448-P	84 x 48	2	1	8	6,374	-	-	-	6,374	6,649	6,917	4,813	-	-	-
TFF-9030-P	90 x 30	2	1	8	5,143	-	-	-	-	-	-	3,887	-	-	-
TFF-9036-P	90 x 36	2	1	8	5,486	-	-	-	-	-	-	4,147	-	-	-
TFF-9042-P	90 x 42	2	1	8	6,338	-	-	-	6,338	6,617	6,890	4,794	-	-	-
TFF-9048-P	90 x 48	2	1	8	6,942	-	-	-	6,942	7,232	7,514	5,252	-	-	-
TFF-9630-P	96 x 30	2	1	8	5,286	-	-	-	-	-	-	4,002	-	-	-
TFF-9636-P	96 x 36	2	1	8	5,652	-	-	-	-	-	-	4,280	-	-	-
TFF-9642-P	96 x 42	2	1	8	6,544	-	-	-	6,544	6,823	7,097	4,958	-	-	-
TFF-9648-P	96 x 48	2	1	8	7,181	-	-	-	7,181	7,470	7,752	5,441	-	-	-
TFF-10242-P	102 x 42	2	1	8	7,125	-	-	-	7,125	7,420	7,708	5,406	-	-	-
TFF-10248-P	102 x 48	2	1	8	7,831	-	-	-	7,831	8,136	8,435	5,943	-	-	-
TFF-10842-P	108 x 42	2	1	10	7,341	-	-	-	7,341	7,636	7,924	5,579	-	-	-
TFF-10848-P	108 x 48	2	1	10	8,083	-	-	-	8,083	8,388	8,686	6,143	-	-	-
TFF-10854-P	108 x 54	2	1	10	8,952	-	-	-	8,952	9,271	9,582	6,804	-	-	-
TFF-11442-P	114 x 42	2	1	10	7,956	-	-	-	7,956	8,266	8,570	6,054	-	-	-
TFF-11448-P	114 x 48	2	1	10	8,773	-	-	-	8,773	9,094	9,408	6,676	-	-	-
TFF-11454-P	114 x 54	2	1	12	9,729	-	-	-	9,729	10,066	10,393	7,404	-	-	-
TFF-12042-P	120 x 42	2	1	10	8,184	-	-	-	8,184	8,495	8,798	6,237	-	-	-
TFF-12048-P	120 x 48	2	1	10	9,038	-	-	-	9,038	9,360	9,674	6,886	-	-	-
TFF-12054-P	120 x 54	2	1	12	10,035	-	-	-	10,035	10,372	10,700	7,646	-	-	-
TFF-13242-P	132 x 42	2	2	10	9,002	-	-	-	9,002	9,325	9,641	6,876	-	-	-
TFF-13248-P	132 x 48	2	2	10	9,966	-	-	-	9,966	10,301	10,628	7,611	-	-	-
TFF-13254-P	132 x 54	2	2	12	11,092	-	-	-	11,092	11,443	11,784	8,470	-	-	-
TFF-14448-P	144 x 48	2	2	12	10,938	-	-	-	10,938	11,287	11,627	8,370	-	-	-
TFF-14454-P	144 x 54	2	2	14	12,200	-	-	-	12,200	12,563	12,919	9,333	-	-	-
TFF-14460-P	144 x 60	2	2	14	13,665	-	-	-	13,665	14,049	14,423	10,450	-	-	-
TFF-15648-P	156 x 48	3	2	14	-	13,943	13,943	13,943	13,943	14,470	14,985	-	10,688	10,688	10,688
TFF-15654-P	156 x 54	3	2	14	-	15,411	15,411	15,411	15,411	15,962	16,499	-	11,809	11,809	11,809
TFF-15660-P	156 x 60	3	2	14	-	17,123	17,123	17,123	17,123	17,704	18,270	-	13,117	13,117	13,117
TFF-16854-P	168 x 54	3	2	16	-	16,165	16,165	16,165	16,165	16,716	17,254	-	12,423	12,423	12,423
TFF-16860-P	168 x 60	3	2	16	-	17,987	17,987	17,987	17,987	18,567	19,134	-	13,815	13,815	13,815
TFF-18054-P	180 x 54	3	2	16	-	16,918	16,918	16,918	16,918	17,469	18,007	-	13,037	13,037	13,037
TFF-18060-P	180 x 60	3	2	16	-	18,849	18,849	18,849	18,849	19,430	19,997	-	14,514	14,514	14,514
TFF-19254-P	192 x 54	3	2	18	-	17,672	17,672	17,672	17,672	18,224	18,762	-	13,650	13,650	13,650
TFF-19260-P	192 x 60	3	2	18	-	19,712	19,712	19,712	19,712	20,293	20,860	-	15,213	15,213	15,213
TFF-20454-P	204 x 54	3	2	18	-	19,175	19,175	19,175	19,175	19,749	20,309	-	14,843	14,843	14,843
TFF-20460-P	204 x 60	3	2	18	-	21,411	21,411	21,411	21,411	22,015	22,605	-	16,557	16,557	16,557
TFF-21654-P	216 x 54	3	2	20	-	20,446	20,446	20,446	20,446	21,033	21,607	-	15,858	15,858	15,858
TFF-21660-P	216 x 60	3	2	20	-	22,852	22,852	22,852	22,852	23,471	24,075	-	17,705	17,705	17,705
TFF-22854-P	228 x 54	3	2	20	-	21,453	21,453	21,453	21,453	22,046	22,625	-	16,670	16,670	16,670
TFF-22860-P	228 x 60	3	2	20	-	24,000	24,000	24,000	24,000	24,624	25,234	-	18,626	18,626	18,626
TFF-24054-P	240 x 54	3	2	20	-	22,516	22,516	22,516	22,516	23,116	23,701	-	17,526	17,526	17,526
TFF-24060-P	240 x 60	3	2	20	-	25,210	25,210	25,210	25,210	25,842	26,459	-	19,596	19,596	19,596



# INSET LAMINATE TOP WITH HARDWOOD EDGE

OPTIONS	CODE	PRICE	NOTES
Power & Data Options			See pages 121-131
<b>Polished Chrome Finish Options:</b>			
Polished Chrome Open Frame Base	Add <b>-PCOF-TWB</b>	\$2,256	
Polished Chrome Post Metal Legs	Add <b>-PCML-TWB</b>	\$1,211	
Polished Chrome Open Frame with X-Center Base	Add <b>-PCOFX-TWB</b>	\$3,383	
Polished Chrome Post Metal Legs with X-Center Base	Add <b>-PCMLX-TWB</b>	\$2,337	
<b>Multi-Section Tops:</b>			
102", 108", 114" and 120" one-piece tops split into two sections	Specify -2	\$795	Note: Power Matrix (center of table location only) cannot be specified when this option is selected
204", 216", 228" or 240" two-piece tops split into four sections	Specify -4	\$1,585	

## EDGE PROFILE

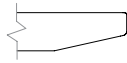

Two4Six Cutback Edge

## GENERAL INFORMATION

- Tops are 1-1/8"-thick
- Seating capacity based on 27" per person
- Overall table height 29.5"
- Standard with quarter cut veneer
- One section of wire management channel provided per table with Post Metal Leg and Open Frame Square Bases
- Racetrack Bases have a removable access door

### REQUIRED INFORMATION (ORDER CANNOT BE ENTERED WITHOUT THIS INFORMATION)

See appendix pages vi-vii for surface material options.

- Choose Laminate Finish
- Choose Wood Species & Finish for Hardwood Edge
- Choose Metal Finish only if -OF or -ML bases specified (Clear Anodized (-CA) is an option on the Post Metal Leg only)
- Choose ABS Finish or Coordinating Woodgrain Edgeband finish if -RCL base specified
- Choose Beam Metal Finish for tables 102"-240"L, with a Racetrack Base (-RCL, -RCP, -RCV)



# LAMINATE TOP WITH ABS CUTBACK EDGE



RECTANGLE TOP

**BASE KEY**

- OF Open Frame
- OFX Open Frame with X Center Base
- OFRP Open Frame with Painted Rectangle Center Base
- OFRV Open Frame with Veneer Rectangle Center Base
- RCL Laminate Racetrack Base
- RCP Painted Racetrack Base
- RCV Veneer Racetrack Base
- ML Post Metal Leg
- MLX Post Metal Leg with X Center Base
- MLRP Post Metal Leg with Painted Rectangle Center Base
- MLRV Post Metal Leg with Veneer Rectangle Center Base

**RECTANGLE TABLES**

MODEL #	L x W	BASE QTY	TOP SECTIONS	SEATING CAPACITY	-OF	-OFX	-OFRP	-OFRV	-RCL	-RCP	-RCV	-ML	-MLX	-MLRP	-MLRV
TFT-6030-PA	60 x 30	2	1	4	3,727	-	-	-	-	-	-	2,784	-	-	-
TFT-6036-PA	60 x 36	2	1	4	3,919	-	-	-	-	-	-	2,931	-	-	-
TFT-6042-PA	60 x 42	2	1	4	4,471	-	-	-	-	-	-	3,346	-	-	-
TFT-6048-PA	60 x 48	2	1	4	4,842	-	-	-	-	-	-	3,626	-	-	-
TFT-6630-PA	66 x 30	2	1	4	4,062	-	-	-	-	-	-	3,042	-	-	-
TFT-6636-PA	66 x 36	2	1	4	4,286	-	-	-	-	-	-	3,213	-	-	-
TFT-6642-PA	66 x 42	2	1	4	4,903	-	-	-	-	-	-	3,678	-	-	-
TFT-6648-PA	66 x 48	2	1	4	5,324	-	-	-	-	-	-	3,996	-	-	-
TFT-7230-PA	72 x 30	2	1	6	4,190	-	-	-	-	-	-	3,145	-	-	-
TFT-7236-PA	72 x 36	2	1	6	4,433	-	-	-	-	-	-	3,331	-	-	-
TFT-7242-PA	72 x 42	2	1	6	5,086	-	-	-	5,086	5,335	5,577	3,824	-	-	-
TFT-7248-PA	72 x 48	2	1	6	5,535	-	-	-	5,535	5,792	6,044	4,164	-	-	-
TFT-7830-PA	78 x 30	2	1	6	4,617	-	-	-	-	-	-	3,474	-	-	-
TFT-7836-PA	78 x 36	2	1	6	4,899	-	-	-	-	-	-	3,689	-	-	-
TFT-7842-PA	78 x 42	2	1	6	5,634	-	-	-	5,634	5,900	6,159	4,244	-	-	-
TFT-7848-PA	78 x 48	2	1	6	6,147	-	-	-	6,147	6,422	6,690	4,633	-	-	-
TFT-8430-PA	84 x 30	2	1	8	4,753	-	-	-	-	-	-	3,584	-	-	-
TFT-8436-PA	84 x 36	2	1	8	5,057	-	-	-	-	-	-	3,815	-	-	-
TFT-8442-PA	84 x 42	2	1	8	5,829	-	-	-	5,829	6,096	6,355	4,400	-	-	-
TFT-8448-PA	84 x 48	2	1	8	6,374	-	-	-	6,374	6,649	6,917	4,813	-	-	-
TFT-9030-PA	90 x 30	2	1	8	5,143	-	-	-	-	-	-	3,887	-	-	-
TFT-9036-PA	90 x 36	2	1	8	5,486	-	-	-	-	-	-	4,147	-	-	-
TFT-9042-PA	90 x 42	2	1	8	6,338	-	-	-	6,338	6,617	6,890	4,794	-	-	-
TFT-9048-PA	90 x 48	2	1	8	6,942	-	-	-	6,942	7,232	7,514	5,252	-	-	-
TFT-9630-PA	96 x 30	2	1	8	5,286	-	-	-	-	-	-	4,002	-	-	-
TFT-9636-PA	96 x 36	2	1	8	5,652	-	-	-	-	-	-	4,280	-	-	-
TFT-9642-PA	96 x 42	2	1	8	6,544	-	-	-	6,544	6,823	7,097	4,958	-	-	-
TFT-9648-PA	96 x 48	2	1	8	7,181	-	-	-	7,181	7,470	7,752	5,441	-	-	-
TFT-10242-PA	102 x 42	2	1	8	7,125	-	-	-	7,125	7,420	7,708	5,406	-	-	-
TFT-10248-PA	102 x 48	2	1	8	7,831	-	-	-	7,831	8,136	8,435	5,943	-	-	-
TFT-10842-PA	108 x 42	2	1	10	7,341	-	-	-	7,341	7,636	7,924	5,579	-	-	-
TFT-10848-PA	108 x 48	2	1	10	8,083	-	-	-	8,083	8,388	8,686	6,143	-	-	-
TFT-10854-PA	108 x 54	2	1	10	8,952	-	-	-	8,952	9,271	9,582	6,804	-	-	-
TFT-11442-PA	114 x 42	2	1	10	7,956	-	-	-	7,956	8,266	8,570	6,054	-	-	-
TFT-11448-PA	114 x 48	2	1	10	8,773	-	-	-	8,773	9,094	9,408	6,676	-	-	-
TFT-11454-PA	114 x 54	2	1	12	9,729	-	-	-	9,729	10,066	10,393	7,404	-	-	-
TFT-12042-PA	120 x 42	2	1	10	8,184	-	-	-	8,184	8,495	8,798	6,237	-	-	-
TFT-12048-PA	120 x 48	2	1	10	9,038	-	-	-	9,038	9,360	9,674	6,886	-	-	-
TFT-12054-PA	120 x 54	2	1	12	10,035	-	-	-	10,035	10,372	10,700	7,646	-	-	-
TFT-13242-PA	132 x 42	2	2	10	9,002	-	-	-	9,002	9,325	9,641	6,876	-	-	-
TFT-13248-PA	132 x 48	2	2	10	9,966	-	-	-	9,966	10,301	10,628	7,611	-	-	-
TFT-13254-PA	132 x 54	2	2	12	11,092	-	-	-	11,092	11,443	11,784	8,470	-	-	-
TFT-14448-PA	144 x 48	2	2	12	10,938	-	-	-	10,938	11,287	11,627	8,370	-	-	-
TFT-14454-PA	144 x 54	2	2	14	12,200	-	-	-	12,200	12,563	12,919	9,333	-	-	-
TFT-14460-PA	144 x 60	2	2	14	13,665	-	-	-	13,665	14,049	14,423	10,450	-	-	-
TFT-15648-PA	156 x 48	3	2	14	-	13,943	13,943	13,943	13,943	14,470	14,985	-	10,688	10,688	10,688
TFT-15654-PA	156 x 54	3	2	14	-	15,411	15,411	15,411	15,411	15,962	16,499	-	11,809	11,809	11,809
TFT-15660-PA	156 x 60	3	2	14	-	17,123	17,123	17,123	17,123	17,704	18,270	-	13,117	13,117	13,117
TFT-16854-PA	168 x 54	3	2	16	-	16,165	16,165	16,165	16,165	16,716	17,254	-	12,423	12,423	12,423
TFT-16860-PA	168 x 60	3	2	16	-	17,987	17,987	17,987	17,987	18,567	19,134	-	13,815	13,815	13,815
TFT-18054-PA	180 x 54	3	2	16	-	16,918	16,918	16,918	16,918	17,469	18,007	-	13,037	13,037	13,037
TFT-18060-PA	180 x 60	3	2	16	-	18,849	18,849	18,849	18,849	19,430	19,997	-	14,514	14,514	14,514
TFT-19254-PA	192 x 54	3	2	18	-	17,672	17,672	17,672	17,672	18,224	18,762	-	13,650	13,650	13,650
TFT-19260-PA	192 x 60	3	2	18	-	19,712	19,712	19,712	19,712	20,293	20,860	-	15,213	15,213	15,213
TFT-20454-PA	204 x 54	3	2	18	-	19,175	19,175	19,175	19,175	19,749	20,309	-	14,843	14,843	14,843
TFT-20460-PA	204 x 60	3	2	18	-	21,411	21,411	21,411	21,411	22,015	22,605	-	16,557	16,557	16,557
TFT-21654-PA	216 x 54	3	2	20	-	20,446	20,446	20,446	20,446	21,033	21,607	-	15,858	15,858	15,858
TFT-21660-PA	216 x 60	3	2	20	-	22,852	22,852	22,852	22,852	23,471	24,075	-	17,705	17,705	17,705
TFT-22854-PA	228 x 54	3	2	20	-	21,453	21,453	21,453	21,453	22,046	22,625	-	16,670	16,670	16,670
TFT-22860-PA	228 x 60	3	2	20	-	24,000	24,000	24,000	24,000	24,624	25,234	-	18,626	18,626	18,626
TFT-24054-PA	240 x 54	3	2	20	-	22,516	22,516	22,516	22,516	23,116	23,701	-	17,526	17,526	17,526
TFT-24060-PA	240 x 60	3	2	20	-	25,210	25,210	25,210	25,210	25,842	26,459	-	19,596	19,596	19,596



# LAMINATE TOP WITH ABS CUTBACK EDGE

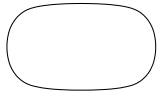

SOFT RECTANGLE TOP

**BASE KEY**

- OF Open Frame
- OFX Open Frame with X Center Base
- OFRP Open Frame with Painted Rectangle Center Base
- OFRV Open Frame with Veneer Rectangle Center Base
- RCL Laminate Racetrack Base
- RCP Painted Racetrack Base
- RCV Veneer Racetrack Base
- ML Post Metal Leg
- MLX Post Metal Leg with X Center Base
- MLRP Post Metal Leg with Painted Rectangle Center Base
- MLRV Post Metal Leg with Veneer Rectangle Center Base

**SOFT RECTANGLE TABLES**

MODEL #	L x W	BASE QTY	TOP SECTIONS	SEATING CAPACITY	-OF	-OFX	-OFRP	-OFRV	-RCL	-RCP	-RCV	-ML	-MLX	-MLRP	-MLRV
TFF-6030-PA	60 x 30	2	1	4	3,727	-	-	-	-	-	-	2,784	-	-	-
TFF-6036-PA	60 x 36	2	1	4	3,919	-	-	-	-	-	-	2,931	-	-	-
TFF-6042-PA	60 x 42	2	1	4	4,471	-	-	-	-	-	-	3,346	-	-	-
TFF-6048-PA	60 x 48	2	1	4	4,842	-	-	-	-	-	-	3,626	-	-	-
TFF-6630-PA	66 x 30	2	1	4	4,062	-	-	-	-	-	-	3,042	-	-	-
TFF-6636-PA	66 x 36	2	1	4	4,286	-	-	-	-	-	-	3,213	-	-	-
TFF-6642-PA	66 x 42	2	1	4	4,903	-	-	-	-	-	-	3,678	-	-	-
TFF-6648-PA	66 x 48	2	1	4	5,324	-	-	-	-	-	-	3,996	-	-	-
TFF-7230-PA	72 x 30	2	1	6	4,190	-	-	-	-	-	-	3,145	-	-	-
TFF-7236-PA	72 x 36	2	1	6	4,433	-	-	-	-	-	-	3,331	-	-	-
TFF-7242-PA	72 x 42	2	1	6	5,086	-	-	-	5,086	5,335	5,577	3,824	-	-	-
TFF-7248-PA	72 x 48	2	1	6	5,535	-	-	-	5,535	5,792	6,044	4,164	-	-	-
TFF-7830-PA	78 x 30	2	1	6	4,617	-	-	-	-	-	-	3,474	-	-	-
TFF-7836-PA	78 x 36	2	1	6	4,899	-	-	-	-	-	-	3,689	-	-	-
TFF-7842-PA	78 x 42	2	1	6	5,634	-	-	-	5,634	5,900	6,159	4,244	-	-	-
TFF-7848-PA	78 x 48	2	1	6	6,147	-	-	-	6,147	6,422	6,690	4,633	-	-	-
TFF-8430-PA	84 x 30	2	1	8	4,753	-	-	-	-	-	-	3,584	-	-	-
TFF-8436-PA	84 x 36	2	1	8	5,057	-	-	-	-	-	-	3,815	-	-	-
TFF-8442-PA	84 x 42	2	1	8	5,829	-	-	-	5,829	6,096	6,355	4,400	-	-	-
TFF-8448-PA	84 x 48	2	1	8	6,374	-	-	-	6,374	6,649	6,917	4,813	-	-	-
TFF-9030-PA	90 x 30	2	1	8	5,143	-	-	-	-	-	-	3,887	-	-	-
TFF-9036-PA	90 x 36	2	1	8	5,486	-	-	-	-	-	-	4,147	-	-	-
TFF-9042-PA	90 x 42	2	1	8	6,338	-	-	-	6,338	6,617	6,890	4,794	-	-	-
TFF-9048-PA	90 x 48	2	1	8	6,942	-	-	-	6,942	7,232	7,514	5,252	-	-	-
TFF-9630-PA	96 x 30	2	1	8	5,286	-	-	-	-	-	-	4,002	-	-	-
TFF-9636-PA	96 x 36	2	1	8	5,652	-	-	-	-	-	-	4,280	-	-	-
TFF-9642-PA	96 x 42	2	1	8	6,544	-	-	-	6,544	6,823	7,097	4,958	-	-	-
TFF-9648-PA	96 x 48	2	1	8	7,181	-	-	-	7,181	7,470	7,752	5,441	-	-	-
TFF-10242-PA	102 x 42	2	1	8	7,125	-	-	-	7,125	7,420	7,708	5,406	-	-	-
TFF-10248-PA	102 x 48	2	1	8	7,831	-	-	-	7,831	8,136	8,435	5,943	-	-	-
TFF-10842-PA	108 x 42	2	1	10	7,341	-	-	-	7,341	7,636	7,924	5,579	-	-	-
TFF-10848-PA	108 x 48	2	1	10	8,083	-	-	-	8,083	8,388	8,686	6,143	-	-	-
TFF-10854-PA	108 x 54	2	1	10	8,952	-	-	-	8,952	9,271	9,582	6,804	-	-	-
TFF-11442-PA	114 x 42	2	1	10	7,956	-	-	-	7,956	8,266	8,570	6,054	-	-	-
TFF-11448-PA	114 x 48	2	1	10	8,773	-	-	-	8,773	9,094	9,408	6,676	-	-	-
TFF-11454-PA	114 x 54	2	1	12	9,729	-	-	-	9,729	10,066	10,393	7,404	-	-	-
TFF-12042-PA	120 x 42	2	1	10	8,184	-	-	-	8,184	8,495	8,798	6,237	-	-	-
TFF-12048-PA	120 x 48	2	1	10	9,038	-	-	-	9,038	9,360	9,674	6,886	-	-	-
TFF-12054-PA	120 x 54	2	1	12	10,035	-	-	-	10,035	10,372	10,700	7,646	-	-	-
TFF-13242-PA	132 x 42	2	2	10	9,002	-	-	-	9,002	9,325	9,641	6,876	-	-	-
TFF-13248-PA	132 x 48	2	2	10	9,966	-	-	-	9,966	10,301	10,628	7,611	-	-	-
TFF-13254-PA	132 x 54	2	2	12	11,092	-	-	-	11,092	11,443	11,784	8,470	-	-	-
TFF-14448-PA	144 x 48	2	2	12	10,938	-	-	-	10,938	11,287	11,627	8,370	-	-	-
TFF-14454-PA	144 x 54	2	2	14	12,200	-	-	-	12,200	12,563	12,919	9,333	-	-	-
TFF-14460-PA	144 x 60	2	2	14	13,665	-	-	-	13,665	14,049	14,423	10,450	-	-	-
TFF-15648-PA	156 x 48	3	2	14	-	13,943	13,943	13,943	13,943	14,470	14,985	-	10,688	10,688	10,688
TFF-15654-PA	156 x 54	3	2	14	-	15,411	15,411	15,411	15,411	15,962	16,499	-	11,809	11,809	11,809
TFF-15660-PA	156 x 60	3	2	14	-	17,123	17,123	17,123	17,123	17,704	18,270	-	13,117	13,117	13,117
TFF-16854-PA	168 x 54	3	2	16	-	16,165	16,165	16,165	16,165	16,716	17,254	-	12,423	12,423	12,423
TFF-16860-PA	168 x 60	3	2	16	-	17,987	17,987	17,987	17,987	18,567	19,134	-	13,815	13,815	13,815
TFF-18054-PA	180 x 54	3	2	16	-	16,918	16,918	16,918	16,918	17,469	18,007	-	13,037	13,037	13,037
TFF-18060-PA	180 x 60	3	2	16	-	18,849	18,849	18,849	18,849	19,430	19,997	-	14,514	14,514	14,514
TFF-19254-PA	192 x 54	3	2	18	-	17,672	17,672	17,672	17,672	18,224	18,762	-	13,650	13,650	13,650
TFF-19260-PA	192 x 60	3	2	18	-	19,712	19,712	19,712	19,712	20,293	20,860	-	15,213	15,213	15,213
TFF-20454-PA	204 x 54	3	2	18	-	19,175	19,175	19,175	19,175	19,749	20,309	-	14,843	14,843	14,843
TFF-20460-PA	204 x 60	3	2	18	-	21,411	21,411	21,411	21,411	22,015	22,605	-	16,557	16,557	16,557
TFF-21654-PA	216 x 54	3	2	20	-	20,446	20,446	20,446	20,446	21,033	21,607	-	15,858	15,858	15,858
TFF-21660-PA	216 x 60	3	2	20	-	22,852	22,852	22,852	22,852	23,471	24,075	-	17,705	17,705	17,705
TFF-22854-PA	228 x 54	3	2	20	-	21,453	21,453	21,453	21,453	22,046	22,625	-	16,670	16,670	16,670
TFF-22860-PA	228 x 60	3	2	20	-	24,000	24,000	24,000	24,000	24,624	25,234	-	18,626	18,626	18,626
TFF-24054-PA	240 x 54	3	2	20	-	22,516	22,516	22,516	22,516	23,116	23,701	-	17,526	17,526	17,526
TFF-24060-PA	240 x 60	3	2	20	-	25,210	25,210	25,210	25,210	25,842	26,459	-	19,596	19,596	19,596



# LAMINATE TOP WITH ABS CUTBACK EDGE

OPTIONS	CODE	PRICE	NOTES
Power & Data Options			See pages 121-131
<b>Polished Chrome Finish Options:</b>			
Polished Chrome Open Frame Base	Add <b>-PCOF-TWB</b>	\$2,256	
Polished Chrome Post Metal Legs	Add <b>-PCML-TWB</b>	\$1,211	
Polished Chrome Open Frame with X-Center Base	Add <b>-PCOFX-TWB</b>	\$3,383	
Polished Chrome Post Metal Legs with X-Center Base	Add <b>-PCMLX-TWB</b>	\$2,337	
<b>Multi-Section Tops:</b>			
102", 108", 114" and 120" one-piece tops split into two sections	Specify -2	\$795	Note: Power Matrix (center of table location only) cannot be specified when this option is selected
204", 216", 228" or 240" two-piece tops split into four sections	Specify -4	\$1,585	

## EDGE PROFILE

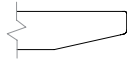

Two4Six Cutback Edge

## GENERAL INFORMATION

- Tops are 1-1/8"-thick
- Seating capacity based on 27" per person
- Overall table height 29.5"
- Standard with quarter cut veneer
- One section of wire management channel provided per table with Post Metal Leg and Open Frame Square Bases
- Racetrack Bases have a removable access door

### REQUIRED INFORMATION (ORDER CANNOT BE ENTERED WITHOUT THIS INFORMATION)

See appendix pages vi-vii for surface material options.

- Choose Laminate Finish
- Choose Metal Finish only if -OF or -ML bases specified (Clear Anodized (-CA) is an option on the Post Metal Leg only)
- Choose ABS Finish or Coordinating Woodgrain Edgeband finish
- Choose Beam Metal Finish for tables 102"-240"L, with a Racetrack Base (-RCL, -RCP, -RCV)



# LAMINATE TOP WITH ABS SQUARE EDGE



RECTANGLE TOP

**BASE KEY**

- OF Open Frame
- OFX Open Frame with X Center Base
- OFRP Open Frame with Painted Rectangle Center Base
- OFRV Open Frame with Veneer Rectangle Center Base
- RCL Laminate Racetrack Base
- RCP Painted Racetrack Base
- RCV Veneer Racetrack Base
- ML Post Metal Leg
- MLX Post Metal Leg with X Center Base
- MLRP Post Metal Leg with Painted Rectangle Center Base
- MLRV Post Metal Leg with Veneer Rectangle Center Base

**RECTANGLE TABLES**

MODEL #	L x W	BASE QTY	TOP SECTIONS	SEATING CAPACITY	-OF	-OFX	-OFRP	-OFRV	-RCL	-RCP	-RCV	-ML	-MLX	-MLRP	-MLRV
TFT-6030-PE	60 x 30	2	1	4	3,352	-	-	-	-	-	-	2,045	-	-	-
TFT-6036-PE	60 x 36	2	1	4	3,525	-	-	-	-	-	-	2,153	-	-	-
TFT-6042-PE	60 x 42	2	1	4	4,022	-	-	-	-	-	-	2,457	-	-	-
TFT-6048-PE	60 x 48	2	1	4	4,355	-	-	-	-	-	-	2,663	-	-	-
TFT-6630-PE	66 x 30	2	1	4	3,654	-	-	-	-	-	-	2,234	-	-	-
TFT-6636-PE	66 x 36	2	1	4	3,855	-	-	-	-	-	-	2,359	-	-	-
TFT-6642-PE	66 x 42	2	1	4	4,410	-	-	-	-	-	-	2,702	-	-	-
TFT-6648-PE	66 x 48	2	1	4	4,789	-	-	-	-	-	-	2,935	-	-	-
TFT-7230-PE	72 x 30	2	1	6	3,769	-	-	-	-	-	-	2,310	-	-	-
TFT-7236-PE	72 x 36	2	1	6	3,988	-	-	-	-	-	-	2,446	-	-	-
TFT-7242-PE	72 x 42	2	1	6	4,575	-	-	-	4,575	4,799	5,016	2,808	-	-	-
TFT-7248-PE	72 x 48	2	1	6	4,979	-	-	-	4,979	5,210	5,436	3,058	-	-	-
TFT-7830-PE	78 x 30	2	1	6	4,153	-	-	-	-	-	-	2,552	-	-	-
TFT-7836-PE	78 x 36	2	1	6	4,407	-	-	-	-	-	-	2,709	-	-	-
TFT-7842-PE	78 x 42	2	1	6	5,067	-	-	-	5,067	5,307	5,540	3,117	-	-	-
TFT-7848-PE	78 x 48	2	1	6	5,529	-	-	-	5,529	5,776	6,018	3,402	-	-	-
TFT-8430-PE	84 x 30	2	1	8	4,275	-	-	-	-	-	-	2,632	-	-	-
TFT-8436-PE	84 x 36	2	1	8	4,549	-	-	-	-	-	-	2,802	-	-	-
TFT-8442-PE	84 x 42	2	1	8	5,243	-	-	-	5,243	5,483	5,716	3,232	-	-	-
TFT-8448-PE	84 x 48	2	1	8	5,733	-	-	-	5,733	5,980	6,222	3,535	-	-	-
TFT-9030-PE	90 x 30	2	1	8	4,626	-	-	-	-	-	-	2,855	-	-	-
TFT-9036-PE	90 x 36	2	1	8	4,935	-	-	-	-	-	-	3,046	-	-	-
TFT-9042-PE	90 x 42	2	1	8	5,701	-	-	-	5,701	5,952	6,198	3,520	-	-	-
TFT-9048-PE	90 x 48	2	1	8	6,245	-	-	-	6,245	6,505	6,759	3,857	-	-	-
TFT-9630-PE	96 x 30	2	1	8	4,755	-	-	-	-	-	-	2,939	-	-	-
TFT-9636-PE	96 x 36	2	1	8	5,083	-	-	-	-	-	-	3,144	-	-	-
TFT-9642-PE	96 x 42	2	1	8	5,886	-	-	-	5,886	6,137	6,383	3,641	-	-	-
TFT-9648-PE	96 x 48	2	1	8	6,459	-	-	-	6,459	6,719	6,973	3,996	-	-	-
TFT-10242-PE	102 x 42	2	1	8	6,409	-	-	-	6,409	6,674	6,933	3,970	-	-	-
TFT-10248-PE	102 x 48	2	1	8	7,044	-	-	-	7,044	7,318	7,587	4,364	-	-	-
TFT-10842-PE	108 x 42	2	1	10	6,603	-	-	-	6,603	6,868	7,128	4,097	-	-	-
TFT-10848-PE	108 x 48	2	1	10	7,271	-	-	-	7,271	7,545	7,813	4,511	-	-	-
TFT-10854-PE	108 x 54	2	1	10	8,052	-	-	-	8,052	8,339	8,619	6,120	-	-	-
TFT-11442-PE	114 x 42	2	1	10	7,157	-	-	-	7,157	7,435	7,708	4,446	-	-	-
TFT-11448-PE	114 x 48	2	1	10	7,891	-	-	-	7,891	8,180	8,462	4,903	-	-	-
TFT-11454-PE	114 x 54	2	1	12	8,751	-	-	-	8,751	9,054	9,348	5,437	-	-	-
TFT-12042-PE	120 x 42	2	1	10	7,361	-	-	-	7,361	7,641	7,914	4,581	-	-	-
TFT-12048-PE	120 x 48	2	1	10	8,129	-	-	-	8,129	8,419	8,701	5,057	-	-	-
TFT-12054-PE	120 x 54	2	1	12	9,027	-	-	-	9,027	9,329	9,624	5,615	-	-	-
TFT-13242-PE	132 x 42	2	2	10	8,097	-	-	-	8,097	8,387	8,672	5,050	-	-	-
TFT-13248-PE	132 x 48	2	2	10	8,965	-	-	-	8,965	9,265	9,560	5,589	-	-	-
TFT-13254-PE	132 x 54	2	2	12	9,977	-	-	-	9,977	10,292	10,599	6,220	-	-	-
TFT-14448-PE	144 x 48	2	2	12	9,838	-	-	-	9,838	10,152	10,458	6,147	-	-	-
TFT-14454-PE	144 x 54	2	2	14	10,973	-	-	-	10,973	11,300	11,620	6,854	-	-	-
TFT-14460-PE	144 x 60	2	2	14	12,291	-	-	-	12,291	12,637	12,973	7,675	-	-	-
TFT-15648-PE	156 x 48	3	2	14	-	12,541	12,541	12,541	12,541	13,016	13,479	-	7,850	7,850	7,850
TFT-15654-PE	156 x 54	3	2	14	-	13,861	13,861	13,861	13,861	14,357	14,841	-	8,673	8,673	8,673
TFT-15660-PE	156 x 60	3	2	14	-	15,402	15,402	15,402	15,402	15,924	16,434	-	9,633	9,633	9,633
TFT-16854-PE	168 x 54	3	2	16	-	14,540	14,540	14,540	14,540	15,035	15,520	-	9,123	9,123	9,123
TFT-16860-PE	168 x 60	3	2	16	-	16,179	16,179	16,179	16,179	16,700	17,210	-	10,146	10,146	10,146
TFT-18054-PE	180 x 54	3	2	16	-	15,217	15,217	15,217	15,217	15,713	16,197	-	9,574	9,574	9,574
TFT-18060-PE	180 x 60	3	2	16	-	16,955	16,955	16,955	16,955	17,476	17,986	-	10,659	10,659	10,659
TFT-19254-PE	192 x 54	3	2	18	-	15,895	15,895	15,895	15,895	16,392	16,876	-	10,025	10,025	10,025
TFT-19260-PE	192 x 60	3	2	18	-	17,731	17,731	17,731	17,731	18,253	18,763	-	11,173	11,173	11,173
TFT-20454-PE	204 x 54	3	2	18	-	17,248	17,248	17,248	17,248	17,764	18,267	-	10,900	10,900	10,900
TFT-20460-PE	204 x 60	3	2	18	-	19,259	19,259	19,259	19,259	19,802	20,332	-	12,159	12,159	12,159
TFT-21654-PE	216 x 54	3	2	20	-	18,390	18,390	18,390	18,390	18,919	19,435	-	11,646	11,646	11,646
TFT-21660-PE	216 x 60	3	2	20	-	20,555	20,555	20,555	20,555	21,112	21,655	-	13,003	13,003	13,003
TFT-22854-PE	228 x 54	3	2	20	-	19,296	19,296	19,296	19,296	19,830	20,350	-	12,243	12,243	12,243
TFT-22860-PE	228 x 60	3	2	20	-	21,587	21,587	21,587	21,587	22,149	22,697	-	13,679	13,679	13,679
TFT-24054-PE	240 x 54	3	2	20	-	20,253	20,253	20,253	20,253	20,792	21,318	-	12,871	12,871	12,871
TFT-24060-PE	240 x 60	3	2	20	-	22,676	22,676	22,676	22,676	23,245	23,799	-	14,391	14,391	14,391



# LAMINATE TOP WITH ABS SQUARE EDGE

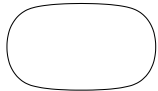

SOFT RECTANGLE TOP

**BASE KEY**

- OF Open Frame
- OFX Open Frame with X Center Base
- OFRP Open Frame with Painted Rectangle Center Base
- OFRV Open Frame with Veneer Rectangle Center Base
- RCL Laminate Racetrack Base
- RCP Painted Racetrack Base
- RCV Veneer Racetrack Base
- ML Post Metal Leg
- MLX Post Metal Leg with X Center Base
- MLRP Post Metal Leg with Painted Rectangle Center Base
- MLRV Post Metal Leg with Veneer Rectangle Center Base

**SOFT RECTANGLE TABLES**

MODEL #	L x W	BASE QTY	TOP SECTIONS	SEATING CAPACITY	-OF	-OFX	-OFRP	-OFRV	-RCL	-RCP	-RCV	-ML	-MLX	-MLRP	-MLRV
TFF-6030-PE	60 x 30	2	1	4	3,352	-	-	-	-	-	-	2,045	-	-	-
TFF-6036-PE	60 x 36	2	1	4	3,525	-	-	-	-	-	-	2,153	-	-	-
TFF-6042-PE	60 x 42	2	1	4	4,022	-	-	-	-	-	-	2,457	-	-	-
TFF-6048-PE	60 x 48	2	1	4	4,355	-	-	-	-	-	-	2,663	-	-	-
TFF-6630-PE	66 x 30	2	1	4	3,654	-	-	-	-	-	-	2,234	-	-	-
TFF-6636-PE	66 x 36	2	1	4	3,855	-	-	-	-	-	-	2,359	-	-	-
TFF-6642-PE	66 x 42	2	1	4	4,410	-	-	-	-	-	-	2,702	-	-	-
TFF-6648-PE	66 x 48	2	1	4	4,789	-	-	-	-	-	-	2,935	-	-	-
TFF-7230-PE	72 x 30	2	1	6	3,769	-	-	-	-	-	-	2,310	-	-	-
TFF-7236-PE	72 x 36	2	1	6	3,988	-	-	-	-	-	-	2,446	-	-	-
TFF-7242-PE	72 x 42	2	1	6	4,575	-	-	-	4,575	4,799	5,016	2,808	-	-	-
TFF-7248-PE	72 x 48	2	1	6	4,979	-	-	-	4,979	5,210	5,436	3,058	-	-	-
TFF-7830-PE	78 x 30	2	1	6	4,153	-	-	-	-	-	-	2,552	-	-	-
TFF-7836-PE	78 x 36	2	1	6	4,407	-	-	-	-	-	-	2,709	-	-	-
TFF-7842-PE	78 x 42	2	1	6	5,067	-	-	-	5,067	5,307	5,540	3,117	-	-	-
TFF-7848-PE	78 x 48	2	1	6	5,529	-	-	-	5,529	5,776	6,018	3,402	-	-	-
TFF-8430-PE	84 x 30	2	1	8	4,275	-	-	-	-	-	-	2,632	-	-	-
TFF-8436-PE	84 x 36	2	1	8	4,549	-	-	-	-	-	-	2,802	-	-	-
TFF-8442-PE	84 x 42	2	1	8	5,243	-	-	-	5,243	5,483	5,716	3,232	-	-	-
TFF-8448-PE	84 x 48	2	1	8	5,733	-	-	-	5,733	5,980	6,222	3,535	-	-	-
TFF-9030-PE	90 x 30	2	1	8	4,626	-	-	-	-	-	-	2,855	-	-	-
TFF-9036-PE	90 x 36	2	1	8	4,935	-	-	-	-	-	-	3,046	-	-	-
TFF-9042-PE	90 x 42	2	1	8	5,701	-	-	-	5,701	5,952	6,198	3,520	-	-	-
TFF-9048-PE	90 x 48	2	1	8	6,245	-	-	-	6,245	6,505	6,759	3,857	-	-	-
TFF-9630-PE	96 x 30	2	1	8	4,755	-	-	-	-	-	-	2,939	-	-	-
TFF-9636-PE	96 x 36	2	1	8	5,083	-	-	-	-	-	-	3,144	-	-	-
TFF-9642-PE	96 x 42	2	1	8	5,886	-	-	-	5,886	6,137	6,383	3,641	-	-	-
TFF-9648-PE	96 x 48	2	1	8	6,459	-	-	-	6,459	6,719	6,973	3,996	-	-	-
TFF-10242-PE	102 x 42	2	1	8	6,409	-	-	-	6,409	6,674	6,933	3,970	-	-	-
TFF-10248-PE	102 x 48	2	1	8	7,044	-	-	-	7,044	7,318	7,587	4,364	-	-	-
TFF-10842-PE	108 x 42	2	1	10	6,603	-	-	-	6,603	6,868	7,128	4,097	-	-	-
TFF-10848-PE	108 x 48	2	1	10	7,271	-	-	-	7,271	7,545	7,813	4,511	-	-	-
TFF-10854-PE	108 x 54	2	1	10	8,052	-	-	-	8,052	8,339	8,619	6,120	-	-	-
TFF-11442-PE	114 x 42	2	1	10	7,157	-	-	-	7,157	7,435	7,708	4,446	-	-	-
TFF-11448-PE	114 x 48	2	1	10	7,891	-	-	-	7,891	8,180	8,462	4,903	-	-	-
TFF-11454-PE	114 x 54	2	1	12	8,751	-	-	-	8,751	9,054	9,348	5,437	-	-	-
TFF-12042-PE	120 x 42	2	1	10	7,361	-	-	-	7,361	7,641	7,914	4,581	-	-	-
TFF-12048-PE	120 x 48	2	1	10	8,129	-	-	-	8,129	8,419	8,701	5,057	-	-	-
TFF-12054-PE	120 x 54	2	1	12	9,027	-	-	-	9,027	9,329	9,624	5,615	-	-	-
TFF-13242-PE	132 x 42	2	2	10	8,097	-	-	-	8,097	8,387	8,672	5,050	-	-	-
TFF-13248-PE	132 x 48	2	2	10	8,965	-	-	-	8,965	9,265	9,560	5,589	-	-	-
TFF-13254-PE	132 x 54	2	2	12	9,977	-	-	-	9,977	10,292	10,599	6,220	-	-	-
TFF-14448-PE	144 x 48	2	2	12	9,838	-	-	-	9,838	10,152	10,458	6,147	-	-	-
TFF-14454-PE	144 x 54	2	2	14	10,973	-	-	-	10,973	11,300	11,620	6,854	-	-	-
TFF-14460-PE	144 x 60	2	2	14	12,291	-	-	-	12,291	12,637	12,973	7,675	-	-	-
TFF-15648-PE	156 x 48	3	2	14	-	12,541	12,541	12,541	12,541	13,016	13,479	-	7,850	7,850	7,850
TFF-15654-PE	156 x 54	3	2	14	-	13,861	13,861	13,861	13,861	14,357	14,841	-	8,673	8,673	8,673
TFF-15660-PE	156 x 60	3	2	14	-	15,402	15,402	15,402	15,402	15,924	16,434	-	9,633	9,633	9,633
TFF-16854-PE	168 x 54	3	2	16	-	14,540	14,540	14,540	14,540	15,035	15,520	-	9,123	9,123	9,123
TFF-16860-PE	168 x 60	3	2	16	-	16,179	16,179	16,179	16,179	16,700	17,210	-	10,146	10,146	10,146
TFF-18054-PE	180 x 54	3	2	16	-	15,217	15,217	15,217	15,217	15,713	16,197	-	9,574	9,574	9,574
TFF-18060-PE	180 x 60	3	2	16	-	16,955	16,955	16,955	16,955	17,476	17,986	-	10,659	10,659	10,659
TFF-19254-PE	192 x 54	3	2	18	-	15,895	15,895	15,895	15,895	16,392	16,876	-	10,025	10,025	10,025
TFF-19260-PE	192 x 60	3	2	18	-	17,731	17,731	17,731	17,731	18,253	18,763	-	11,173	11,173	11,173
TFF-20454-PE	204 x 54	3	2	18	-	17,248	17,248	17,248	17,248	17,764	18,267	-	10,900	10,900	10,900
TFF-20460-PE	204 x 60	3	2	18	-	19,259	19,259	19,259	19,259	19,802	20,332	-	12,159	12,159	12,159
TFF-21654-PE	216 x 54	3	2	20	-	18,390	18,390	18,390	18,390	18,919	19,435	-	11,646	11,646	11,646
TFF-21660-PE	216 x 60	3	2	20	-	20,555	20,555	20,555	20,555	21,112	21,655	-	13,003	13,003	13,003
TFF-22854-PE	228 x 54	3	2	20	-	19,296	19,296	19,296	19,296	19,830	20,350	-	12,243	12,243	12,243
TFF-22860-PE	228 x 60	3	2	20	-	21,587	21,587	21,587	21,587	22,149	22,697	-	13,679	13,679	13,679
TFF-24054-PE	240 x 54	3	2	20	-	20,253	20,253	20,253	20,253	20,792	21,318	-	12,871	12,871	12,871
TFF-24060-PE	240 x 60	3	2	20	-	22,676	22,676	22,676	22,676	23,245	23,799	-	14,391	14,391	14,391





# LAMINATE TOP WITH ABS SQUARE EDGE

OPTIONS	CODE	PRICE	NOTES
Power & Data Options			See pages 121-131
<b>Polished Chrome Finish Options:</b>			
Polished Chrome Open Frame Base	Add -PCOF-TWB	\$2,256	
Polished Chrome Post Metal Legs	Add -PCML-TWB	\$1,211	
Polished Chrome Open Frame with X-Center Base	Add -PCOFX-TWB	\$3,383	
Polished Chrome Post Metal Legs with X-Center Base	Add -PCMLX-TWB	\$2,337	
<b>Multi-Section Tops:</b>			
102", 108", 114" and 120" one-piece tops split into two sections	Specify -2	\$795	Note: Power Matrix (center of table location only) cannot be specified when this option is selected
204", 216", 228" or 240" two-piece tops split into four sections	Specify -4	\$1,585	

## EDGE PROFILE



Two4Six Square Edge

## GENERAL INFORMATION

- Tops are 1-1/8"-thick
- Seating capacity based on 27" per person
- Overall table height 29.5"
- Standard with quarter cut veneer
- One section of wire management channel provided per table with Post Metal Leg and Open Frame Square Bases
- Racetrack Bases have a removable access door

### REQUIRED INFORMATION (ORDER CANNOT BE ENTERED WITHOUT THIS INFORMATION)

See appendix pages vi-vii for surface material options.

- Choose Laminate Finish
- Choose ABS Finish or Coordinating Woodgrain Edgeband finish
- Choose Metal Finish only if -OF or -ML bases specified (Clear Anodized (-CA) is an option on the Post Metal Leg only)
- Choose Beam Metal Finish for tables 102"-240"L, with a Racetrack Base (-RCL, -RCP, -RCV)



# GLASS TOP



RECTANGLE TOP

### BASE KEY

OF	Open Frame	RCL	Laminate Racetrack Base
OFX	Open Frame with X Center Base	RCP	Painted Racetrack Base
OFRP	Open Frame with Painted Rectangle Center Base	RCV	Veneer Racetrack Base
OFRV	Open Frame with Veneer Rectangle Center Base		

### RECTANGLE TABLES

MODEL #	L x W	BASE QTY	GLASS SECTIONS	SEATING CAPACITY	-OF	-OFX	-OFRP	-OFRV	-RCL	-RCP	-RCV
TFT-6030-G	60 x 30	2	1	4	6,152	-	-	-	-	-	-
TFT-6036-G	60 x 36	2	1	4	6,470	-	-	-	-	-	-
TFT-6042-G	60 x 42	2	1	4	7,381	-	-	-	-	-	-
TFT-6048-G	60 x 48	2	1	4	7,992	-	-	-	-	-	-
TFT-6630-G	66 x 30	2	1	4	6,705	-	-	-	-	-	-
TFT-6636-G	66 x 36	2	1	4	7,075	-	-	-	-	-	-
TFT-6642-G	66 x 42	2	1	4	8,094	-	-	-	-	-	-
TFT-6648-G	66 x 48	2	1	4	8,788	-	-	-	-	-	-
TFT-7230-G	72 x 30	2	1	6	6,916	-	-	-	-	-	-
TFT-7236-G	72 x 36	2	1	6	7,318	-	-	-	-	-	-
TFT-7242-G	72 x 42	2	1	6	8,396	-	-	-	8,396	8,807	9,206
TFT-7248-G	72 x 48	2	1	6	9,137	-	-	-	9,137	9,562	9,977
TFT-7830-G	78 x 30	2	1	6	7,621	-	-	-	-	-	-
TFT-7836-G	78 x 36	2	1	6	8,088	-	-	-	-	-	-
TFT-7842-G	78 x 42	2	1	6	9,300	-	-	-	9,300	9,740	10,167
TFT-7848-G	78 x 48	2	1	6	10,147	-	-	-	10,147	10,601	11,044
TFT-8430-G	84 x 30	2	1	8	7,846	-	-	-	-	-	-
TFT-8436-G	84 x 36	2	1	8	8,348	-	-	-	-	-	-
TFT-8442-G	84 x 42	2	1	8	9,623	-	-	-	9,623	10,062	10,490
TFT-8448-G	84 x 48	2	1	8	10,521	-	-	-	10,521	10,975	11,418
TFT-9030-G	90 x 30	2	1	8	8,490	-	-	-	-	-	-
TFT-9036-G	90 x 36	2	1	8	9,056	-	-	-	-	-	-
TFT-9042-G	90 x 42	2	1	8	10,462	-	-	-	10,462	10,924	11,374
TFT-9048-G	90 x 48	2	1	8	11,460	-	-	-	11,460	11,938	12,404
TFT-9630-G	96 x 30	2	1	8	8,726	-	-	-	-	-	-
TFT-9636-G	96 x 36	2	1	8	9,329	-	-	-	-	-	-
TFT-9642-G	96 x 42	2	1	8	10,802	-	-	-	10,802	11,264	11,715
TFT-9648-G	96 x 48	2	1	8	11,853	-	-	-	11,853	12,331	12,797
TFT-10242-G	102 x 42	2	2	8	11,761	-	-	-	11,761	12,248	12,724
TFT-10248-G	102 x 48	2	2	8	12,927	-	-	-	12,927	13,431	13,923
TFT-10842-G	108 x 42	2	2	10	12,119	-	-	-	12,119	12,605	13,081
TFT-10848-G	108 x 48	2	2	10	13,343	-	-	-	13,343	13,847	14,338
TFT-10854-G	108 x 54	2	2	10	14,777	-	-	-	14,777	15,304	15,817
TFT-11442-G	114 x 42	2	2	10	13,134	-	-	-	13,134	13,646	14,147
TFT-11448-G	114 x 48	2	2	10	14,482	-	-	-	14,482	15,012	15,530
TFT-11454-G	114 x 54	2	2	12	16,061	-	-	-	16,061	16,616	17,156
TFT-12042-G	120 x 42	2	2	10	13,510	-	-	-	13,510	14,023	14,524
TFT-12048-G	120 x 48	2	2	10	14,919	-	-	-	14,919	15,451	15,969
TFT-12054-G	120 x 54	2	2	12	16,566	-	-	-	16,566	17,121	17,663
TFT-13242-G	132 x 42	2	3	10	14,859	-	-	-	14,859	15,393	15,916
TFT-13248-G	132 x 48	2	3	10	16,452	-	-	-	16,452	17,004	17,544
TFT-13254-G	132 x 54	2	3	12	18,310	-	-	-	18,310	18,889	19,452
TFT-14448-G	144 x 48	2	3	12	18,056	-	-	-	18,056	18,632	19,193
TFT-14454-G	144 x 54	2	2	14	20,139	-	-	-	20,139	20,739	21,326
TFT-14460-G	144 x 60	2	3	14	22,558	-	-	-	22,558	23,191	23,809
TFT-15648-G	156 x 48	3	3	14	-	23,017	23,017	23,017	23,017	23,887	24,737
TFT-15654-G	156 x 54	3	3	14	-	25,439	25,439	25,439	25,439	26,349	27,237
TFT-15660-G	156 x 60	3	3	14	-	28,266	28,266	28,266	28,266	29,226	30,160
TFT-16854-G	168 x 54	3	3	16	-	26,684	26,684	26,684	26,684	27,594	28,483
TFT-16860-G	168 x 60	3	3	16	-	29,692	29,692	29,692	29,692	30,650	31,586
TFT-18054-G	180 x 54	3	3	16	-	27,928	27,928	27,928	27,928	28,837	29,726
TFT-18060-G	180 x 60	3	3	16	-	31,116	31,116	31,116	31,116	32,074	33,010
TFT-19254-G	192 x 54	3	4	18	-	29,172	29,172	29,172	29,172	30,084	30,971
TFT-19260-G	192 x 60	3	4	18	-	32,541	32,541	32,541	32,541	33,500	34,436
TFT-20454-G	204 x 54	3	4	18	-	31,654	31,654	31,654	31,654	32,601	33,525
TFT-20460-G	204 x 60	3	4	18	-	35,345	35,345	35,345	35,345	36,342	37,316
TFT-21654-G	216 x 54	3	4	20	-	33,751	33,751	33,751	33,751	34,721	35,668
TFT-21660-G	216 x 60	3	4	20	-	37,724	37,724	37,724	37,724	38,746	39,743
TFT-22854-G	228 x 54	3	4	20	-	35,414	35,414	35,414	35,414	36,394	37,348
TFT-22860-G	228 x 60	3	4	20	-	39,618	39,618	39,618	39,618	40,649	41,656
TFT-24054-G	240 x 54	3	4	20	-	37,169	37,169	37,169	37,169	38,160	39,125
TFT-24060-G	240 x 60	3	4	20	-	41,617	41,617	41,617	41,617	42,660	43,677



# GLASS TOP

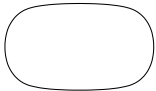

SOFT RECTANGLE TOP

### BASE KEY

OF	Open Frame	RCL	Laminate Racetrack Base
OFX	Open Frame with X Center Base	RCP	Painted Racetrack Base
OFRP	Open Frame with Painted Rectangle Center Base	RCV	Veneer Racetrack Base
OFRV	Open Frame with Veneer Rectangle Center Base		

### SOFT RECTANGLE TABLES

MODEL #	L x W	BASE QTY	GLASS SECTIONS	SEATING CAPACITY	-OF	-OFX	-OFRP	-OFRV	-RCL	-RCP	-RCV
TFF-6030-G	60 x 30	2	1	4	6,152	-	-	-	-	-	-
TFF-6036-G	60 x 36	2	1	4	6,470	-	-	-	-	-	-
TFF-6042-G	60 x 42	2	1	4	7,381	-	-	-	-	-	-
TFF-6048-G	60 x 48	2	1	4	7,992	-	-	-	-	-	-
TFF-6630-G	66 x 30	2	1	4	6,705	-	-	-	-	-	-
TFF-6636-G	66 x 36	2	1	4	7,075	-	-	-	-	-	-
TFF-6642-G	66 x 42	2	1	4	8,094	-	-	-	-	-	-
TFF-6648-G	66 x 48	2	1	4	8,788	-	-	-	-	-	-
TFF-7230-G	72 x 30	2	1	6	6,916	-	-	-	-	-	-
TFF-7236-G	72 x 36	2	1	6	7,318	-	-	-	-	-	-
TFF-7242-G	72 x 42	2	1	6	8,396	-	-	-	8,396	8,807	9,206
TFF-7248-G	72 x 48	2	1	6	9,137	-	-	-	9,137	9,562	9,977
TFF-7830-G	78 x 30	2	1	6	7,621	-	-	-	-	-	-
TFF-7836-G	78 x 36	2	1	6	8,088	-	-	-	-	-	-
TFF-7842-G	78 x 42	2	1	6	9,300	-	-	-	9,300	9,740	10,167
TFF-7848-G	78 x 48	2	1	6	10,147	-	-	-	10,147	10,601	11,044
TFF-8430-G	84 x 30	2	1	8	7,846	-	-	-	-	-	-
TFF-8436-G	84 x 36	2	1	8	8,348	-	-	-	-	-	-
TFF-8442-G	84 x 42	2	1	8	9,623	-	-	-	9,623	10,062	10,490
TFF-8448-G	84 x 48	2	1	8	10,521	-	-	-	10,521	10,975	11,418
TFF-9030-G	90 x 30	2	1	8	8,490	-	-	-	-	-	-
TFF-9036-G	90 x 36	2	1	8	9,056	-	-	-	-	-	-
TFF-9042-G	90 x 42	2	1	8	10,462	-	-	-	10,462	10,924	11,374
TFF-9048-G	90 x 48	2	1	8	11,460	-	-	-	11,460	11,938	12,404
TFF-9630-G	96 x 30	2	1	8	8,726	-	-	-	-	-	-
TFF-9636-G	96 x 36	2	1	8	9,329	-	-	-	-	-	-
TFF-9642-G	96 x 42	2	1	8	10,802	-	-	-	10,802	11,264	11,715
TFF-9648-G	96 x 48	2	1	8	11,853	-	-	-	11,853	12,331	12,797
TFF-10242-G	102 x 42	2	2	8	11,761	-	-	-	11,761	12,248	12,724
TFF-10248-G	102 x 48	2	2	8	12,927	-	-	-	12,927	13,431	13,923
TFF-10842-G	108 x 42	2	2	10	12,119	-	-	-	12,119	12,605	13,081
TFF-10848-G	108 x 48	2	2	10	13,343	-	-	-	13,343	13,847	14,338
TFF-10854-G	108 x 54	2	2	10	14,777	-	-	-	14,777	15,304	15,817
TFF-11442-G	114 x 42	2	2	10	13,134	-	-	-	13,134	13,646	14,147
TFF-11448-G	114 x 48	2	2	10	14,482	-	-	-	14,482	15,012	15,530
TFF-11454-G	114 x 54	2	2	12	16,061	-	-	-	16,061	16,616	17,156
TFF-12042-G	120 x 42	2	2	10	13,510	-	-	-	13,510	14,023	14,524
TFF-12048-G	120 x 48	2	2	10	14,919	-	-	-	14,919	15,451	15,969
TFF-12054-G	120 x 54	2	2	12	16,566	-	-	-	16,566	17,121	17,663
TFF-13242-G	132 x 42	2	3	10	14,859	-	-	-	14,859	15,393	15,916
TFF-13248-G	132 x 48	2	3	10	16,452	-	-	-	16,452	17,004	17,544
TFF-13254-G	132 x 54	2	3	12	18,310	-	-	-	18,310	18,889	19,452
TFF-14448-G	144 x 48	2	3	12	18,056	-	-	-	18,056	18,632	19,193
TFF-14454-G	144 x 54	2	2	14	20,139	-	-	-	20,139	20,739	21,326
TFF-14460-G	144 x 60	2	3	14	22,558	-	-	-	22,558	23,191	23,809
TFF-15648-G	156 x 48	3	3	14	-	23,017	23,017	23,017	23,017	23,887	24,737
TFF-15654-G	156 x 54	3	3	14	-	25,439	25,439	25,439	25,439	26,349	27,237
TFF-15660-G	156 x 60	3	3	14	-	28,266	28,266	28,266	28,266	29,226	30,160
TFF-16854-G	168 x 54	3	3	16	-	26,684	26,684	26,684	26,684	27,594	28,483
TFF-16860-G	168 x 60	3	3	16	-	29,692	29,692	29,692	29,692	30,650	31,586
TFF-18054-G	180 x 54	3	3	16	-	27,928	27,928	27,928	27,928	28,837	29,726
TFF-18060-G	180 x 60	3	3	16	-	31,116	31,116	31,116	31,116	32,074	33,010
TFF-19254-G	192 x 54	3	4	18	-	29,172	29,172	29,172	29,172	30,084	30,971
TFF-19260-G	192 x 60	3	4	18	-	32,541	32,541	32,541	32,541	33,500	34,436
TFF-20454-G	204 x 54	3	4	18	-	31,654	31,654	31,654	31,654	32,601	33,525
TFF-20460-G	204 x 60	3	4	18	-	35,345	35,345	35,345	35,345	36,342	37,316
TFF-21654-G	216 x 54	3	4	20	-	33,751	33,751	33,751	33,751	34,721	35,668
TFF-21660-G	216 x 60	3	4	20	-	37,724	37,724	37,724	37,724	38,746	39,743
TFF-22854-G	228 x 54	3	4	20	-	35,414	35,414	35,414	35,414	36,394	37,348
TFF-22860-G	228 x 60	3	4	20	-	39,618	39,618	39,618	39,618	40,649	41,656
TFF-24054-G	240 x 54	3	4	20	-	37,169	37,169	37,169	37,169	38,160	39,125
TFF-24060-G	240 x 60	3	4	20	-	41,617	41,617	41,617	41,617	42,660	43,677



# GLASS TOP

OPTIONS	CODE	PRICE	NOTES
Power & Data Options			See pages 121-131
<b>Polished Chrome Finish Options:</b>			
Polished Chrome Open Frame Base	Add -PCOF-TWB	\$2,256	
Polished Chrome Open Frame with X-Center Base	Add -PCOFX-TWB	\$3,383	
<b>Satin Glass Options:</b>			
60"-96" Tables	Add -TFSG	\$655	
102"-132" Tables	Add -TFSG	\$872	
144"-180" Tables	Add -TFSG	\$1,092	
192"-228" Tables	Add -TFSG	\$1,403	
240" Tables	Add -TFSG	\$1,610	
<b>Multi-Section Tops:</b>			
102", 108", 114" and 120" one-piece tops split into two sections	Specify -2	\$795	Note: Power Matrix (center of table location only) cannot be specified when this option is selected
204", 216", 228" or 240" two-piece tops split into four sections	Specify -4	\$1,585	

## EDGE PROFILE

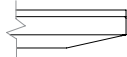

Two4Six Glass Edge

## GENERAL INFORMATION

- Tops are 1-1/8"-thick with 3/16"-thick hardwood edge band
- Seating capacity based on 27" per person
- Overall table height 29.5"
- One section of wire management channel provided per table with Post Metal Leg and Open Frame Square Bases
- Racetrack Bases have a removable access door

### REQUIRED INFORMATION (ORDER CANNOT BE ENTERED WITHOUT THIS INFORMATION)

See appendix pages vi-vii for surface material options.

- Choose Glass Finish
- Choose Veneer Finish, if applicable
- Choose Metal Finish, if applicable
- Choose Paint Finish, if applicable
- Choose Sub-Top Finish: Paint Finish or Wood Species & Finish
- Choose ABS Finish or Coordinating Woodgrain Edgeband finish if -RCL base specified
- Choose Beam Metal Finish for tables 102"-240" L, with a Racetrack Base (-RCL, -RCP, -RCV)



# SOLID SURFACE TOP



RECTANGLE TOP

**BASE KEY**

- OF Open Frame
- OFX Open Frame with X Center Base
- OFRP Open Frame with Painted Rectangle Center Base
- OFRV Open Frame with Veneer Rectangle Center Base
- RCL Laminate Racetrack Base
- RCP Painted Racetrack Base
- RCV Veneer Racetrack Base

**RECTANGLE TABLES**

MODEL #	L x W	BASE QTY	GLASS SECTIONS	SEATING CAPACITY	-OF	-OFX	-OFRP	-OFRV	-RCL	-RCP	-RCV
TFT-6030-SS	60 x 30	2	1	4	6,428	-	-	-	-	-	-
TFT-6036-SS	60 x 36	2	1	4	6,760	-	-	-	-	-	-
TFT-6042-SS	60 x 42	2	1	4	7,712	-	-	-	-	-	-
TFT-6048-SS	60 x 48	2	1	4	8,351	-	-	-	-	-	-
TFT-6630-SS	66 x 30	2	1	4	7,006	-	-	-	-	-	-
TFT-6636-SS	66 x 36	2	1	4	7,393	-	-	-	-	-	-
TFT-6642-SS	66 x 42	2	1	4	8,457	-	-	-	-	-	-
TFT-6648-SS	66 x 48	2	1	4	9,182	-	-	-	-	-	-
TFT-7230-SS	72 x 30	2	1	6	7,226	-	-	-	-	-	-
TFT-7236-SS	72 x 36	2	1	6	7,647	-	-	-	-	-	-
TFT-7242-SS	72 x 42	2	1	6	8,773	-	-	-	8,773	9,202	9,619
TFT-7248-SS	72 x 48	2	1	6	9,547	-	-	-	9,547	9,991	10,424
TFT-7830-SS	78 x 30	2	1	6	7,963	-	-	-	-	-	-
TFT-7836-SS	78 x 36	2	1	6	8,450	-	-	-	-	-	-
TFT-7842-SS	78 x 42	2	1	6	9,717	-	-	-	9,717	10,177	10,623
TFT-7848-SS	78 x 48	2	1	6	10,602	-	-	-	10,602	11,076	11,539
TFT-8430-SS	84 x 30	2	1	8	8,198	-	-	-	-	-	-
TFT-8436-SS	84 x 36	2	1	8	8,723	-	-	-	-	-	-
TFT-8442-SS	84 x 42	2	1	8	10,054	-	-	-	10,054	10,514	10,961
TFT-8448-SS	84 x 48	2	1	8	10,993	-	-	-	10,993	11,468	11,930
TFT-9030-SS	90 x 30	2	1	8	8,871	-	-	-	-	-	-
TFT-9036-SS	90 x 36	2	1	8	9,463	-	-	-	-	-	-
TFT-9042-SS	90 x 42	2	1	8	10,931	-	-	-	10,931	11,414	11,885
TFT-9048-SS	90 x 48	2	1	8	11,974	-	-	-	11,974	12,473	12,961
TFT-9630-SS	96 x 30	2	1	8	9,117	-	-	-	-	-	-
TFT-9636-SS	96 x 36	2	1	8	9,748	-	-	-	-	-	-
TFT-9642-SS	96 x 42	2	1	8	11,287	-	-	-	11,287	11,769	12,240
TFT-9648-SS	96 x 48	2	1	8	12,385	-	-	-	12,385	12,884	13,371
TFT-10242-SS	102 x 42	2	2	8	12,289	-	-	-	12,289	12,798	13,295
TFT-10248-SS	102 x 48	2	2	8	13,507	-	-	-	13,507	14,033	14,548
TFT-10842-SS	108 x 42	2	2	10	12,662	-	-	-	12,662	13,171	13,668
TFT-10848-SS	108 x 48	2	2	10	13,942	-	-	-	13,942	14,468	14,982
TFT-10854-SS	108 x 54	2	2	10	15,440	-	-	-	15,440	15,991	16,527
TFT-11442-SS	114 x 42	2	2	10	13,723	-	-	-	13,723	14,258	14,781
TFT-11448-SS	114 x 48	2	2	10	15,132	-	-	-	15,132	15,686	16,227
TFT-11454-SS	114 x 54	2	2	12	16,781	-	-	-	16,781	17,362	17,926
TFT-12042-SS	120 x 42	2	2	10	14,116	-	-	-	14,116	14,653	15,176
TFT-12048-SS	120 x 48	2	2	10	15,588	-	-	-	15,588	16,144	16,685
TFT-12054-SS	120 x 54	2	2	12	17,309	-	-	-	17,309	17,890	18,455
TFT-13242-SS	132 x 42	2	3	10	15,526	-	-	-	15,526	16,084	16,630
TFT-13248-SS	132 x 48	2	3	10	17,190	-	-	-	17,190	17,767	18,331
TFT-13254-SS	132 x 54	2	3	12	19,132	-	-	-	19,132	19,737	20,325
TFT-14448-SS	144 x 48	2	3	12	18,866	-	-	-	18,866	19,468	20,054
TFT-14454-SS	144 x 54	2	2	14	21,042	-	-	-	21,042	21,670	22,283
TFT-14460-SS	144 x 60	2	3	14	23,570	-	-	-	23,570	24,232	24,878
TFT-15648-SS	156 x 48	3	3	14	-	24,050	24,050	24,050	24,050	24,959	25,847
TFT-15654-SS	156 x 54	3	3	14	-	26,581	26,581	26,581	26,581	27,531	28,459
TFT-15660-SS	156 x 60	3	3	14	-	29,534	29,534	29,534	29,534	30,537	31,513
TFT-16854-SS	168 x 54	3	3	16	-	27,882	27,882	27,882	27,882	28,832	29,761
TFT-16860-SS	168 x 60	3	3	16	-	31,024	31,024	31,024	31,024	32,025	33,003
TFT-18054-SS	180 x 54	3	3	16	-	29,181	29,181	29,181	29,181	30,131	31,060
TFT-18060-SS	180 x 60	3	3	16	-	32,512	32,512	32,512	32,512	33,513	34,491
TFT-19254-SS	192 x 54	3	4	18	-	30,481	30,481	30,481	30,481	31,433	32,361
TFT-19260-SS	192 x 60	3	4	18	-	34,001	34,001	34,001	34,001	35,003	35,981
TFT-20454-SS	204 x 54	3	4	18	-	33,075	33,075	33,075	33,075	34,064	35,029
TFT-20460-SS	204 x 60	3	4	18	-	36,931	36,931	36,931	36,931	37,973	38,990
TFT-21654-SS	216 x 54	3	4	20	-	35,266	35,266	35,266	35,266	36,279	37,269
TFT-21660-SS	216 x 60	3	4	20	-	39,417	39,417	39,417	39,417	40,485	41,526
TFT-22854-SS	228 x 54	3	4	20	-	37,003	37,003	37,003	37,003	38,027	39,024
TFT-22860-SS	228 x 60	3	4	20	-	41,396	41,396	41,396	41,396	42,473	43,525
TFT-24054-SS	240 x 54	3	4	20	-	38,837	38,837	38,837	38,837	39,872	40,881
TFT-24060-SS	240 x 60	3	4	20	-	43,484	43,484	43,484	43,484	44,574	45,637



# SOLID SURFACE TOP

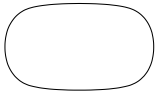

SOFT RECTANGLE TOP

**BASE KEY**

- OF Open Frame
- OFX Open Frame with X Center Base
- OFRP Open Frame with Painted Rectangle Center Base
- OFRV Open Frame with Veneer Rectangle Center Base
- RCL Laminate Racetrack Base
- RCP Painted Racetrack Base
- RCV Veneer Racetrack Base

**SOFT RECTANGLE TABLES**

MODEL #	L x W	BASE QTY	GLASS SECTIONS	SEATING CAPACITY	-OF	-OFX	-OFRP	-OFRV	-RCL	-RCP	-RCV
TFF-6030-SS	60 x 30	2	1	4	6,428	-	-	-	-	-	-
TFF-6036-SS	60 x 36	2	1	4	6,760	-	-	-	-	-	-
TFF-6042-SS	60 x 42	2	1	4	7,712	-	-	-	-	-	-
TFF-6048-SS	60 x 48	2	1	4	8,351	-	-	-	-	-	-
TFF-6630-SS	66 x 30	2	1	4	7,006	-	-	-	-	-	-
TFF-6636-SS	66 x 36	2	1	4	7,393	-	-	-	-	-	-
TFF-6642-SS	66 x 42	2	1	4	8,457	-	-	-	-	-	-
TFF-6648-SS	66 x 48	2	1	4	9,182	-	-	-	-	-	-
TFF-7230-SS	72 x 30	2	1	6	7,226	-	-	-	-	-	-
TFF-7236-SS	72 x 36	2	1	6	7,647	-	-	-	-	-	-
TFF-7242-SS	72 x 42	2	1	6	8,773	-	-	-	8,773	9,202	9,619
TFF-7248-SS	72 x 48	2	1	6	9,547	-	-	-	9,547	9,991	10,424
TFF-7830-SS	78 x 30	2	1	6	7,963	-	-	-	-	-	-
TFF-7836-SS	78 x 36	2	1	6	8,450	-	-	-	-	-	-
TFF-7842-SS	78 x 42	2	1	6	9,717	-	-	-	9,717	10,177	10,623
TFF-7848-SS	78 x 48	2	1	6	10,602	-	-	-	10,602	11,076	11,539
TFF-8430-SS	84 x 30	2	1	8	8,198	-	-	-	-	-	-
TFF-8436-SS	84 x 36	2	1	8	8,723	-	-	-	-	-	-
TFF-8442-SS	84 x 42	2	1	8	10,054	-	-	-	10,054	10,514	10,961
TFF-8448-SS	84 x 48	2	1	8	10,993	-	-	-	10,993	11,468	11,930
TFF-9030-SS	90 x 30	2	1	8	8,871	-	-	-	-	-	-
TFF-9036-SS	90 x 36	2	1	8	9,463	-	-	-	-	-	-
TFF-9042-SS	90 x 42	2	1	8	10,931	-	-	-	10,931	11,414	11,885
TFF-9048-SS	90 x 48	2	1	8	11,974	-	-	-	11,974	12,473	12,961
TFF-9630-SS	96 x 30	2	1	8	9,117	-	-	-	-	-	-
TFF-9636-SS	96 x 36	2	1	8	9,748	-	-	-	-	-	-
TFF-9642-SS	96 x 42	2	1	8	11,287	-	-	-	11,287	11,769	12,240
TFF-9648-SS	96 x 48	2	1	8	12,385	-	-	-	12,385	12,884	13,371
TFF-10242-SS	102 x 42	2	2	8	12,289	-	-	-	12,289	12,798	13,295
TFF-10248-SS	102 x 48	2	2	8	13,507	-	-	-	13,507	14,033	14,548
TFF-10842-SS	108 x 42	2	2	10	12,662	-	-	-	12,662	13,171	13,668
TFF-10848-SS	108 x 48	2	2	10	13,942	-	-	-	13,942	14,468	14,982
TFF-10854-SS	108 x 54	2	2	10	15,440	-	-	-	15,440	15,991	16,527
TFF-11442-SS	114 x 42	2	2	10	13,723	-	-	-	13,723	14,258	14,781
TFF-11448-SS	114 x 48	2	2	10	15,132	-	-	-	15,132	15,686	16,227
TFF-11454-SS	114 x 54	2	2	12	16,781	-	-	-	16,781	17,362	17,926
TFF-12042-SS	120 x 42	2	2	10	14,116	-	-	-	14,116	14,653	15,176
TFF-12048-SS	120 x 48	2	2	10	15,588	-	-	-	15,588	16,144	16,685
TFF-12054-SS	120 x 54	2	2	12	17,309	-	-	-	17,309	17,890	18,455
TFF-13242-SS	132 x 42	2	3	10	15,526	-	-	-	15,526	16,084	16,630
TFF-13248-SS	132 x 48	2	3	10	17,190	-	-	-	17,190	17,767	18,331
TFF-13254-SS	132 x 54	2	3	12	19,132	-	-	-	19,132	19,737	20,325
TFF-14448-SS	144 x 48	2	3	12	18,866	-	-	-	18,866	19,468	20,054
TFF-14454-SS	144 x 54	2	2	14	21,042	-	-	-	21,042	21,670	22,283
TFF-14460-SS	144 x 60	2	3	14	23,570	-	-	-	23,570	24,232	24,878
TFF-15648-SS	156 x 48	3	3	14	-	24,050	24,050	24,050	24,050	24,959	25,847
TFF-15654-SS	156 x 54	3	3	14	-	26,581	26,581	26,581	26,581	27,531	28,459
TFF-15660-SS	156 x 60	3	3	14	-	29,534	29,534	29,534	29,534	30,537	31,513
TFF-16854-SS	168 x 54	3	3	16	-	27,882	27,882	27,882	27,882	28,832	29,761
TFF-16860-SS	168 x 60	3	3	16	-	31,024	31,024	31,024	31,024	32,025	33,003
TFF-18054-SS	180 x 54	3	3	16	-	29,181	29,181	29,181	29,181	30,131	31,060
TFF-18060-SS	180 x 60	3	3	16	-	32,512	32,512	32,512	32,512	33,513	34,491
TFF-19254-SS	192 x 54	3	4	18	-	30,481	30,481	30,481	30,481	31,433	32,361
TFF-19260-SS	192 x 60	3	4	18	-	34,001	34,001	34,001	34,001	35,003	35,981
TFF-20454-SS	204 x 54	3	4	18	-	33,075	33,075	33,075	33,075	34,064	35,029
TFF-20460-SS	204 x 60	3	4	18	-	36,931	36,931	36,931	36,931	37,973	38,990
TFF-21654-SS	216 x 54	3	4	20	-	35,266	35,266	35,266	35,266	36,279	37,269
TFF-21660-SS	216 x 60	3	4	20	-	39,417	39,417	39,417	39,417	40,485	41,526
TFF-22854-SS	228 x 54	3	4	20	-	37,003	37,003	37,003	37,003	38,027	39,024
TFF-22860-SS	228 x 60	3	4	20	-	41,396	41,396	41,396	41,396	42,473	43,525
TFF-24054-SS	240 x 54	3	4	20	-	38,837	38,837	38,837	38,837	39,872	40,881
TFF-24060-SS	240 x 60	3	4	20	-	43,484	43,484	43,484	43,484	44,574	45,637



# SOLID SURFACE TOP

OPTIONS	CODE	PRICE	NOTES
Power & Data Options			See pages 121-131
<b>Polished Chrome Finish Options:</b>			
Polished Chrome Open Frame Base	Add -PCOF-TWB	\$2,256	
Polished Chrome Open Frame with X-Center Base	Add -PCOFX-TWB	\$3,383	
<b>Multi-Section Tops:</b>			
102", 108", 114" and 120" one-piece tops split into two sections	Specify -2	\$795	Note: Power Matrix (center of table location only) cannot be specified when this option is selected
204", 216", 228" or 240" two-piece tops split into four sections	Specify -4	\$1,585	

## EDGE PROFILE



Two4Six Solid Surface Edge

## GENERAL INFORMATION

- Seating capacity based on 27" per person
- Overall table height 29.5"
- One section of wire management channel provided per table with Post Metal Leg and Open Frame Square Bases
- Racetrack Bases have a removable access door

### REQUIRED INFORMATION (ORDER CANNOT BE ENTERED WITHOUT THIS INFORMATION)

See appendix pages vi-vii for surface material options.

- Choose Solid Surface Finish
- Choose Metal Finish
- Choose ABS Finish or Coordinating Woodgrain Edgeband finish if -RCL base specified
- Choose Beam Metal Finish for tables 102"-240"L, with a Racetrack Base (-RCL, -RCP, -RCV)



# VENEER TOP WITH HARDWOOD EDGE / VENEER CASE



D-SHAPE TOP

### BASE KEY

OF	Open Frame	RCL	Laminate Racetrack Base
ML	Post Metal Leg	RCP	Painted Racetrack Base
		RCV	Veneer Racetrack Base

## D-SHAPE TOP // 60" CREDENZA BASE // SEATED HEIGHT

MODEL #	LENGTH	WIDTH	HEIGHT	CREDENZA BASE	SEATING CAPACITY	-OF	-ML	-RCL	-RCP	-RCV
TFL-3060-V	60	30	29-1/2	60	3	8,947	8,947	-	-	-
TFL-3660-V	60	36	29-1/2	60	3	9,151	9,151	-	-	-
TFL-4260-V	60	42	29-1/2	60	3	10,172	10,172	-	-	-
TFL-4860-V	60	48	29-1/2	60	3	10,751	10,751	-	-	-
TFL-3066-V	66	30	29-1/2	60	3	9,580	9,580	-	-	-
TFL-3666-V	66	36	29-1/2	60	3	9,817	9,817	-	-	-
TFL-4266-V	66	42	29-1/2	60	3	10,932	10,932	-	-	-
TFL-4866-V	66	48	29-1/2	60	3	11,575	11,575	-	-	-
TFL-3072-V	72	30	29-1/2	60	3	9,715	9,715	-	-	-
TFL-3672-V	72	36	29-1/2	60	3	9,973	9,973	-	-	-
TFL-4272-V	72	42	29-1/2	60	3	11,126	11,126	11,126	11,671	12,247
TFL-4872-V	72	48	29-1/2	60	3	11,799	11,799	11,799	12,363	12,959
TFL-3078-V	78	30	29-1/2	60	5	10,533	10,533	-	-	-
TFL-3678-V	78	36	29-1/2	60	5	10,832	10,832	-	-	-
TFL-4278-V	78	42	29-1/2	60	5	12,104	12,104	12,104	12,687	13,304
TFL-4878-V	78	48	29-1/2	60	5	12,858	12,858	12,858	13,461	14,099
TFL-3084-V	84	30	29-1/2	60	5	10,678	10,678	-	-	-
TFL-3684-V	84	36	29-1/2	60	5	11,000	11,000	-	-	-
TFL-4284-V	84	42	29-1/2	60	5	12,311	12,311	12,311	12,894	13,510
TFL-4884-V	84	48	29-1/2	60	5	13,098	13,098	13,098	13,701	14,339
TFL-3090-V	90	30	29-1/2	60	5	11,384	11,384	-	-	-
TFL-3690-V	90	36	29-1/2	60	5	11,747	11,747	-	-	-
TFL-4290-V	90	42	29-1/2	60	5	13,168	13,168	13,168	13,781	14,430
TFL-4890-V	90	48	29-1/2	60	5	14,031	14,031	14,031	14,665	15,336
TFL-3096-V	96	30	29-1/2	60	5	11,536	11,536	-	-	-
TFL-3696-V	96	36	29-1/2	60	5	11,923	11,923	-	-	-
TFL-4296-V	96	42	29-1/2	60	5	13,386	13,386	13,386	13,999	14,647
TFL-4896-V	96	48	29-1/2	60	5	14,283	14,283	14,283	14,917	15,588

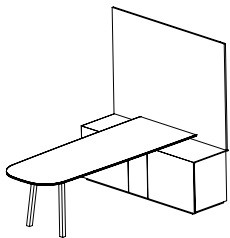

Shown with optional Monitor Panel (-MP)

### OPTIONS

Power & Data Options

See pages 121-131

#### Polished Chrome Finish Options:

Polished Chrome Open Frame Base	Add -PCOF-TWA	\$1,280
Polished Chrome Post Metal Legs	Add -PCML-TWA	\$590

#### Credenza Base Options:

60"-wide Monitor Panel	Add -MP	\$2,717
Pull-out Waste/Recycling Unit (Left End Opening)	Add -TE	\$479
Locks	Add -L	\$242

### EDGE PROFILE



Two4Six Cutback Edge

### GENERAL INFORMATION

- Tops are 1-1/8" -thick with 3/16" -thick hardwood edge band
- Seating capacity based on 27" per person
- Overall table height 29.5". Overall height 78" if Monitor Panel is specified.
- Standard with quarter cut veneer
- Pull-Out Waste/Recycling option is located on left side of unit if specified
- Adjustable shelves standard
- Access door on the credenza base standard with a lock. All doors will be keyed alike if locks are specified.
- Credenza base is 22" -deep, the Monitor Panel adds 2" making the depth 24"
- Plinth base is veneer and recessed 1" on all sides
- One section of wire management channel provided per table with Post Metal Leg and Open Frame Bases
- Pull-Out Waste/Recycling Bin size: 14" x 10-1/2" x 18"
- Only Woodgrain Laminate options are available for the Racetrack Base
- Racetrack Bases have a removable access door

#### REQUIRED INFORMATION (ORDER CANNOT BE ENTERED WITHOUT THIS INFORMATION)

See appendix pages vi-vii for surface material options.

- Choose Veneer Finish
- Choose ABS Finish or Coordinating Woodgrain Edgeband finish if -RCL base specified
- Choose Metal Finish, if -OF or -ML Base is specified (Clear Anodized (-CA) is an option on the Post Metal Leg only)





# INSET LAMINATE TOP WITH HARDWOOD EDGE / VENEER CASE



D-SHAPE TOP

**BASE KEY**

OF	Open Frame	RCL	Laminate Racetrack Base
ML	Post Metal Leg	RCP	Painted Racetrack Base
		RCV	Veneer Racetrack Base

**D-SHAPE TOP // 60" CREDENZA BASE // SEATED HEIGHT**

MODEL #	LENGTH	WIDTH	HEIGHT	CREDENZA BASE	SEATING CAPACITY	-OF	-ML	-RCL	-RCP	-RCV
TFL-3060-P	60	30	29-1/2	60	3	8,455	8,455	-	-	-
TFL-3660-P	60	36	29-1/2	60	3	8,648	8,648	-	-	-
TFL-4260-P	60	42	29-1/2	60	3	9,613	9,613	-	-	-
TFL-4860-P	60	48	29-1/2	60	3	10,160	10,160	-	-	-
TFL-3066-P	66	30	29-1/2	60	3	9,054	9,054	-	-	-
TFL-3666-P	66	36	29-1/2	60	3	9,278	9,278	-	-	-
TFL-4266-P	66	42	29-1/2	60	3	10,331	10,331	-	-	-
TFL-4866-P	66	48	29-1/2	60	3	10,939	10,939	-	-	-
TFL-3072-P	72	30	29-1/2	60	3	9,181	9,181	-	-	-
TFL-3672-P	72	36	29-1/2	60	3	9,425	9,425	-	-	-
TFL-4272-P	72	42	29-1/2	60	3	10,515	10,515	10,515	11,030	11,574
TFL-4872-P	72	48	29-1/2	60	3	11,151	11,151	11,151	11,684	12,247
TFL-3078-P	78	30	29-1/2	60	5	9,954	9,954	-	-	-
TFL-3678-P	78	36	29-1/2	60	5	10,237	10,237	-	-	-
TFL-4278-P	78	42	29-1/2	60	5	11,439	11,439	11,439	11,990	12,573
TFL-4878-P	78	48	29-1/2	60	5	12,151	12,151	12,151	12,721	13,324
TFL-3084-P	84	30	29-1/2	60	5	10,091	10,091	-	-	-
TFL-3684-P	84	36	29-1/2	60	5	10,395	10,395	-	-	-
TFL-4284-P	84	42	29-1/2	60	5	11,634	11,634	11,634	12,185	12,767
TFL-4884-P	84	48	29-1/2	60	5	12,378	12,378	12,378	12,948	13,551
TFL-3090-P	90	30	29-1/2	60	5	10,758	10,758	-	-	-
TFL-3690-P	90	36	29-1/2	60	5	11,101	11,101	-	-	-
TFL-4290-P	90	42	29-1/2	60	5	12,444	12,444	12,444	13,024	13,637
TFL-4890-P	90	48	29-1/2	60	5	13,260	13,260	13,260	13,859	14,493
TFL-3096-P	96	30	29-1/2	60	5	10,902	10,902	-	-	-
TFL-3696-P	96	36	29-1/2	60	5	11,268	11,268	-	-	-
TFL-4296-P	96	42	29-1/2	60	5	12,650	12,650	12,650	13,230	13,842
TFL-4896-P	96	48	29-1/2	60	5	13,498	13,498	13,498	14,097	14,731

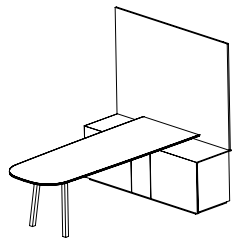

Shown with optional Monitor Panel (-MP)

**OPTIONS**

Power & Data Options

See pages 121-131

**Polished Chrome Finish Options:**

Polished Chrome Open Frame Base	Add <b>-PCOF-TWA</b>	\$1,280
Polished Chrome Post Metal Legs	Add <b>-PCML-TWA</b>	\$590

**Credenza Base Options:**

60"-wide Monitor Panel	Add <b>-MP</b>	\$2,717
Pull-out Waste/Recycling Unit (Left End Opening)	Add <b>-TE</b>	\$479
Locks	Add <b>-L</b>	\$242

**EDGE PROFILE**



Two4Six Cutback Edge

**GENERAL INFORMATION**

- Tops are 1-1/8" -thick with 3/16" -thick hardwood edge band
- Seating capacity based on 27" per person
- Overall table height 29.5". Overall height 78" if Monitor Panel is specified.
- Standard with quarter cut veneer
- Pull-Out Waste/Recycling option is located on left side of unit if specified
- Adjustable shelves standard
- Access door on the credenza base standard with a lock. All doors will be keyed alike if locks are specified.
- Credenza base is 22" -deep, the Monitor Panel adds 2" making the depth 24"
- Plinth base is veneer and recessed 1" on all sides
- One section of wire management channel provided per table with Post Metal Leg and Open Frame Bases
- Pull-Out Waste/Recycling Bin size: 14" x 10-1/2" x 18"
- Only Woodgrain Laminate options are available for the Racetrack Base
- Racetrack Bases have a removable access door

**REQUIRED INFORMATION (ORDER CANNOT BE ENTERED WITHOUT THIS INFORMATION)**

See appendix pages vi-vii for surface material options.

- Choose Laminate Finish
- Choose Wood Species & Finish for Hardwood Edge
- Choose Veneer Finish
- Choose Metal Finish, if -OF or -ML Base is specified (Clear Anodized (-CA) is an option on the Post Metal Leg only)
- Choose ABS Finish or Coordinating Woodgrain Edgeband finish if -RCL base specified



# LAMINATE TOP WITH ABS CUTBACK EDGE / VENEER CASE



D-SHAPE TOP

### BASE KEY

OF	Open Frame	RCL	Laminate Racetrack Base
ML	Post Metal Leg	RCP	Painted Racetrack Base
		RCV	Veneer Racetrack Base

## D-SHAPE TOP // 60" CREDENZA BASE // SEATED HEIGHT

MODEL #	LENGTH	WIDTH	HEIGHT	CREDENZA BASE	SEATING CAPACITY	-OF	-ML	-RCL	-RCP	-RCV
TFL-3060-PA	60	30	29-1/2	60	3	8,455	8,455	-	-	-
TFL-3660-PA	60	36	29-1/2	60	3	8,648	8,648	-	-	-
TFL-4260-PA	60	42	29-1/2	60	3	9,613	9,613	-	-	-
TFL-4860-PA	60	48	29-1/2	60	3	10,160	10,160	-	-	-
TFL-3066-PA	66	30	29-1/2	60	3	9,054	9,054	-	-	-
TFL-3666-PA	66	36	29-1/2	60	3	9,278	9,278	-	-	-
TFL-4266-PA	66	42	29-1/2	60	3	10,331	10,331	-	-	-
TFL-4866-PA	66	48	29-1/2	60	3	10,939	10,939	-	-	-
TFL-3072-PA	72	30	29-1/2	60	3	9,181	9,181	-	-	-
TFL-3672-PA	72	36	29-1/2	60	3	9,425	9,425	-	-	-
TFL-4272-PA	72	42	29-1/2	60	3	10,515	10,515	10,515	11,030	11,574
TFL-4872-PA	72	48	29-1/2	60	3	11,151	11,151	11,151	11,684	12,247
TFL-3078-PA	78	30	29-1/2	60	5	9,954	9,954	-	-	-
TFL-3678-PA	78	36	29-1/2	60	5	10,237	10,237	-	-	-
TFL-4278-PA	78	42	29-1/2	60	5	11,439	11,439	11,439	11,990	12,573
TFL-4878-PA	78	48	29-1/2	60	5	12,151	12,151	12,151	12,721	13,324
TFL-3084-PA	84	30	29-1/2	60	5	10,091	10,091	-	-	-
TFL-3684-PA	84	36	29-1/2	60	5	10,395	10,395	-	-	-
TFL-4284-PA	84	42	29-1/2	60	5	11,634	11,634	11,634	12,185	12,767
TFL-4884-PA	84	48	29-1/2	60	5	12,378	12,378	12,378	12,948	13,551
TFL-3090-PA	90	30	29-1/2	60	5	10,758	10,758	-	-	-
TFL-3690-PA	90	36	29-1/2	60	5	11,101	11,101	-	-	-
TFL-4290-PA	90	42	29-1/2	60	5	12,444	12,444	12,444	13,024	13,637
TFL-4890-PA	90	48	29-1/2	60	5	13,260	13,260	13,260	13,859	14,493
TFL-3096-PA	96	30	29-1/2	60	5	10,902	10,902	-	-	-
TFL-3696-PA	96	36	29-1/2	60	5	11,268	11,268	-	-	-
TFL-4296-PA	96	42	29-1/2	60	5	12,650	12,650	12,650	13,230	13,842
TFL-4896-PA	96	48	29-1/2	60	5	13,498	13,498	13,498	14,097	14,731

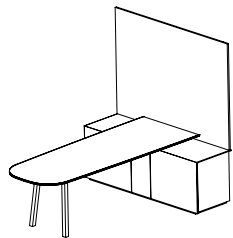

Shown with optional Monitor Panel (-MP)

### OPTIONS

Power & Data Options

See pages 121-131

#### Polished Chrome Finish Options:

Polished Chrome Open Frame Base	Add -PCOF-TWA	\$1,280
Polished Chrome Post Metal Legs	Add -PCML-TWA	\$590

#### Credenza Base Options:

60"-wide Monitor Panel	Add -MP	\$2,717
Pull-out Waste/Recycling Unit (Left End Opening)	Add -TE	\$479
Locks	Add -L	\$242

### EDGE PROFILE



Two4Six Cutback Edge

### GENERAL INFORMATION

- Tops are 1-1/8" -thick
- Seating capacity based on 27" per person
- Overall table height 29.5". Overall height 78" if Monitor Panel is specified.
- Standard with quarter cut veneer
- Pull-Out Waste/Recycling option is located on left side of unit if specified
- Adjustable shelves standard
- Access door on the credenza base standard with a lock. All doors will be keyed alike if locks are specified.
- Credenza base is 22"-deep, the Monitor Panel adds 2" making the depth 24"
- Plinth base is veneer and recessed 1" on all sides
- One section of wire management channel provided per table with Post Metal Leg and Open Frame Bases
- Pull-Out Waste/Recycling Bin size: 14" x 10-1/2" x 18"
- Only Woodgrain Laminate options are available for the Racetrack Base
- Racetrack Bases have a removable access door

#### REQUIRED INFORMATION (ORDER CANNOT BE ENTERED WITHOUT THIS INFORMATION)

See appendix pages vi-vii for surface material options.

- Choose Laminate Finish
- Choose Veneer Finish
- Choose Metal Finish, if -OF or -ML Base is specified (Clear Anodized (-CA) is an option on the Post Metal Leg only)
- Choose ABS Edge Finish or Coordinating Woodgrain Edgeband finish



# LAMINATE TOP WITH ABS SQUARE EDGE / VENEER CASE



D-SHAPE TOP

### BASE KEY

OF	Open Frame	RCL	Laminate Racetrack Base
ML	Post Metal Leg	RCP	Painted Racetrack Base
		RCV	Veneer Racetrack Base

## D-SHAPE TOP // 60" CREDENZA BASE // SEATED HEIGHT

MODEL #	LENGTH	WIDTH	HEIGHT	CREDENZA BASE	SEATING CAPACITY	-OF	-ML	-RCL	-RCP	-RCV
TFL-3060-PE	60	30	29-1/2	60	3	8,035	8,035	-	-	-
TFL-3660-PE	60	36	29-1/2	60	3	8,218	8,218	-	-	-
TFL-4260-PE	60	42	29-1/2	60	3	9,135	9,135	-	-	-
TFL-4860-PE	60	48	29-1/2	60	3	9,655	9,655	-	-	-
TFL-3066-PE	66	30	29-1/2	60	3	8,603	8,603	-	-	-
TFL-3666-PE	66	36	29-1/2	60	3	8,816	8,816	-	-	-
TFL-4266-PE	66	42	29-1/2	60	3	9,817	9,817	-	-	-
TFL-4866-PE	66	48	29-1/2	60	3	10,395	10,395	-	-	-
TFL-3072-PE	72	30	29-1/2	60	3	8,725	8,725	-	-	-
TFL-3672-PE	72	36	29-1/2	60	3	8,956	8,956	-	-	-
TFL-4272-PE	72	42	29-1/2	60	3	9,992	9,992	9,992	10,481	10,998
TFL-4872-PE	72	48	29-1/2	60	3	10,596	10,596	10,596	11,102	11,638
TFL-3078-PE	78	30	29-1/2	60	5	9,459	9,459	-	-	-
TFL-3678-PE	78	36	29-1/2	60	5	9,728	9,728	-	-	-
TFL-4278-PE	78	42	29-1/2	60	5	10,870	10,870	10,870	11,393	11,947
TFL-4878-PE	78	48	29-1/2	60	5	11,547	11,547	11,547	12,088	12,661
TFL-3084-PE	84	30	29-1/2	60	5	9,589	9,589	-	-	-
TFL-3684-PE	84	36	29-1/2	60	5	9,878	9,878	-	-	-
TFL-4284-PE	84	42	29-1/2	60	5	11,056	11,056	11,056	11,579	12,132
TFL-4884-PE	84	48	29-1/2	60	5	11,763	11,763	11,763	12,304	12,877
TFL-3090-PE	90	30	29-1/2	60	5	10,223	10,223	-	-	-
TFL-3690-PE	90	36	29-1/2	60	5	10,549	10,549	-	-	-
TFL-4290-PE	90	42	29-1/2	60	5	11,825	11,825	11,825	12,376	12,959
TFL-4890-PE	90	48	29-1/2	60	5	12,600	12,600	12,600	13,170	13,772
TFL-3096-PE	96	30	29-1/2	60	5	10,360	10,360	-	-	-
TFL-3696-PE	96	36	29-1/2	60	5	10,707	10,707	-	-	-
TFL-4296-PE	96	42	29-1/2	60	5	12,021	12,021	12,021	12,572	13,154
TFL-4896-PE	96	48	29-1/2	60	5	12,827	12,827	12,827	13,396	13,999

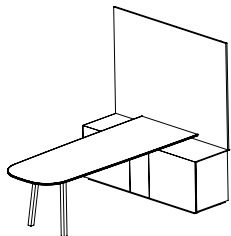

Shown with optional Monitor Panel (-MP)

### OPTIONS

Power & Data Options

See pages 121-131

#### Polished Chrome Finish Options:

Polished Chrome Open Frame Base	Add -PCOF-TWA	\$1,280
Polished Chrome Post Metal Legs	Add -PCML-TWA	\$590

#### Credenza Base Options:

60"-wide Monitor Panel	Add -MP	\$2,717
Pull-out Waste/Recycling Unit (Left End Opening)	Add -TE	\$479
Locks	Add -L	\$242

### EDGE PROFILE



Two4Six Square Edge

### GENERAL INFORMATION

- Tops are 1-1/8"-thick
- Seating capacity based on 27" per person
- Overall table height 29.5". Overall height 78" if Monitor Panel is specified.
- Standard with quarter cut veneer
- Pull-Out Waste/Recycling option is located on left side of unit if specified
- Adjustable shelves standard
- Access door on the credenza base standard with a lock. All doors will be keyed alike if locks are specified.
- Credenza base is 22"-deep, the Monitor Panel adds 2" making the depth 24"
- Plinth base is veneer and recessed 1" on all sides
- One section of wire management channel provided per table with Post Metal Leg and Open Frame Bases
- Pull-Out Waste/Recycling Bin size: 14" x 10-1/2" x 18"
- Only Woodgrain Laminate options are available for the Racetrack Base
- Racetrack Bases have a removable access door

#### REQUIRED INFORMATION (ORDER CANNOT BE ENTERED WITHOUT THIS INFORMATION)

See appendix pages vi-vii for surface material options.

- Choose Laminate Finish
- Choose ABS Edge Finish or Coordinating Woodgrain Edgeband finish
- Choose Veneer Finish
- Choose Metal Finish, if -OF or -ML Base is specified (Clear Anodized (-CA) is an option on the Post Metal Leg only)



# GLASS TOP / VENEER CASE



D-SHAPE TOP

### BASE KEY

OF Open Frame

RCL Laminate Racetrack Base  
RCP Painted Racetrack Base  
RCV Veneer Racetrack Base

## D-SHAPE TOP // 60" CREDENZA BASE // SEATED HEIGHT

MODEL #	LENGTH	WIDTH	HEIGHT	CREDENZA BASE	SEATING CAPACITY	-OF	-RCL	-RCP	-RCV
TFL-3060-G	60	30	29-1/2	60	3	13,958	-	-	-
TFL-3660-G	60	36	29-1/2	60	3	14,276	-	-	-
TFL-4260-G	60	42	29-1/2	60	3	15,869	-	-	-
TFL-4860-G	60	48	29-1/2	60	3	16,772	-	-	-
TFL-3066-G	66	30	29-1/2	60	3	14,945	-	-	-
TFL-3666-G	66	36	29-1/2	60	3	15,315	-	-	-
TFL-4266-G	66	42	29-1/2	60	3	17,054	-	-	-
TFL-4866-G	66	48	29-1/2	60	3	18,057	-	-	-
TFL-3072-G	72	30	29-1/2	60	3	15,156	-	-	-
TFL-3672-G	72	36	29-1/2	60	3	15,558	-	-	-
TFL-4272-G	72	42	29-1/2	60	3	17,357	17,357	18,207	19,106
TFL-4872-G	72	48	29-1/2	60	3	18,407	18,407	19,287	20,217
TFL-3078-G	78	30	29-1/2	60	5	16,432	-	-	-
TFL-3678-G	78	36	29-1/2	60	5	16,898	-	-	-
TFL-4278-G	78	42	29-1/2	60	5	18,883	18,883	19,792	20,755
TFL-4878-G	78	48	29-1/2	60	5	20,059	20,059	21,000	21,995
TFL-3084-G	84	30	29-1/2	60	5	16,658	-	-	-
TFL-3684-G	84	36	29-1/2	60	5	17,160	-	-	-
TFL-4284-G	84	42	29-1/2	60	5	19,206	19,206	20,115	21,076
TFL-4884-G	84	48	29-1/2	60	5	20,433	20,433	21,374	22,369
TFL-3090-G	90	30	29-1/2	60	5	17,760	-	-	-
TFL-3690-G	90	36	29-1/2	60	5	18,326	-	-	-
TFL-4290-G	90	42	29-1/2	60	5	20,543	20,543	21,499	22,511
TFL-4890-G	90	48	29-1/2	60	5	21,889	21,889	22,878	23,925
TFL-3096-G	96	30	29-1/2	60	5	17,997	-	-	-
TFL-3696-G	96	36	29-1/2	60	5	18,600	-	-	-
TFL-4296-G	96	42	29-1/2	60	5	20,883	20,883	21,839	22,850
TFL-4896-G	96	48	29-1/2	60	5	22,282	22,282	23,271	24,318

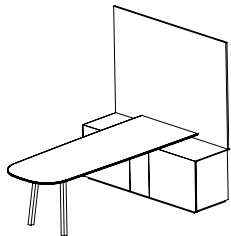

Shown with optional Monitor Panel (-MP)

### OPTIONS

Power & Data Options

See pages 121-131

#### Polished Chrome Finish Options:

Polished Chrome Open Frame Base Add **-PCOF-TWA** \$1,280

#### Satin Glass Options:

Satin Glass Add **-TFSG** \$661

#### Credenza Base Options:

60" -wide Monitor Panel Add **-MP** \$2,717  
Pull-out Waste/Recycling Unit (Left End Opening) Add **-TE** \$479  
Locks Add **-L** \$242

### EDGE PROFILE

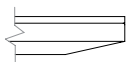

Two4Six Glass Edge

### GENERAL INFORMATION

- Tops are 1-1/8"-thick with 3/16"-thick hardwood edge band
- Seating capacity based on 27" per person
- Overall table height 29.5". Overall height 78" if Monitor Panel is specified.
- Standard with quarter cut veneer
- Pull-Out Waste/Recycling option is located on left side of unit if specified
- Adjustable shelves standard
- All doors will be keyed alike if locks are specified
- Lock color will default to metal color
- Access door on the credenza base standard with a lock
- Credenza base is 22"-deep, the Monitor Panel adds 2" making the depth 24"
- Plinth base is veneer and recessed 1" on all sides
- One section of wire management channel provided per table
- Pull-Out Waste/Recycling Bin size: 14" x 10-1/2" x 18"
- Only Woodgrain Laminate options are available for the Racetrack Base
- Racetrack Bases have a removable access door

### REQUIRED INFORMATION (ORDER CANNOT BE ENTERED WITHOUT THIS INFORMATION)

See appendix pages vi-vii for surface material options.

- Choose Glass Finish
- Choose Veneer Finish, if applicable
- Choose Paint Finish if -PA is specified
- Choose Metal Finish
- Choose ABS Finish or Coordinating Woodgrain Edgeband finish if -RCL base specified
- Choose Sub-Top Finish: Paint Finish or Wood Species & Finish



# SOLID SURFACE TOP / VENEER CASE



D-SHAPE TOP

### BASE KEY

OF Open Frame

RCL Laminate Racetrack Base  
RCP Painted Racetrack Base  
RCV Veneer Racetrack Base

## D-SHAPE TOP // 60" CREDENZA BASE // SEATED HEIGHT

MODEL #	LENGTH	WIDTH	HEIGHT	CREDENZA BASE	SEATING CAPACITY	-OF	-RCL	-RCP	-RCV
TFL-3060-SS	60	30	29-1/2	60	3	14,584	-	-	-
TFL-3660-SS	60	36	29-1/2	60	3	14,917	-	-	-
TFL-4260-SS	60	42	29-1/2	60	3	16,581	-	-	-
TFL-4860-SS	60	48	29-1/2	60	3	17,525	-	-	-
TFL-3066-SS	66	30	29-1/2	60	3	15,616	-	-	-
TFL-3666-SS	66	36	29-1/2	60	3	16,002	-	-	-
TFL-4266-SS	66	42	29-1/2	60	3	17,820	-	-	-
TFL-4866-SS	66	48	29-1/2	60	3	18,868	-	-	-
TFL-3072-SS	72	30	29-1/2	60	3	15,836	-	-	-
TFL-3672-SS	72	36	29-1/2	60	3	16,256	-	-	-
TFL-4272-SS	72	42	29-1/2	60	3	18,136	18,136	19,024	19,963
TFL-4872-SS	72	48	29-1/2	60	3	19,233	19,233	20,152	21,124
TFL-3078-SS	78	30	29-1/2	60	5	17,169	-	-	-
TFL-3678-SS	78	36	29-1/2	60	5	17,657	-	-	-
TFL-4278-SS	78	42	29-1/2	60	5	19,730	19,730	20,680	21,686
TFL-4878-SS	78	48	29-1/2	60	5	20,959	20,959	21,942	22,982
TFL-3084-SS	84	30	29-1/2	60	5	17,406	-	-	-
TFL-3684-SS	84	36	29-1/2	60	5	17,930	-	-	-
TFL-4284-SS	84	42	29-1/2	60	5	20,067	20,067	21,018	22,022
TFL-4884-SS	84	48	29-1/2	60	5	21,350	21,350	22,333	23,373
TFL-3090-SS	90	30	29-1/2	60	5	18,556	-	-	-
TFL-3690-SS	90	36	29-1/2	60	5	19,148	-	-	-
TFL-4290-SS	90	42	29-1/2	60	5	21,464	21,464	22,464	23,521
TFL-4890-SS	90	48	29-1/2	60	5	22,871	22,871	23,904	24,998
TFL-3096-SS	96	30	29-1/2	60	5	18,804	-	-	-
TFL-3696-SS	96	36	29-1/2	60	5	19,435	-	-	-
TFL-4296-SS	96	42	29-1/2	60	5	21,820	21,820	22,819	23,875
TFL-4896-SS	96	48	29-1/2	60	5	23,282	23,282	24,315	25,409

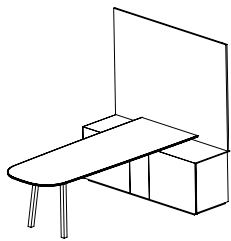

Shown with optional Monitor Panel (-MP)

### OPTIONS

Power & Data Options

See pages 121-131

#### Polished Chrome Finish Options:

Polished Chrome Open Frame Base Add **-PCOF-TWA** \$1,280

#### Credenza Base Options:

60"-wide Monitor Panel Add **-MP** \$2,717  
Pull-out Waste/Recycling Unit (Left End Opening) Add **-TE** \$479  
Locks Add **-L** \$242

### EDGE PROFILE

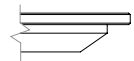

Two4Six Solid Surface Edge

### GENERAL INFORMATION

- Seating capacity based on 27" per person
- Overall table height 29.5". Overall height 78" if Monitor Panel is specified.
- Standard with quarter cut veneer
- Pull-Out Waste/Recycling option is located on left side of unit if specified
- Adjustable shelves standard
- All doors will be keyed alike if locks are specified
- Lock color will default to metal color
- Access door on the credenza base standard with a lock
- Credenza base is 22"-deep, the Monitor Panel adds 2" making the depth 24"
- Plinth base is veneer and recessed 1" on all sides
- One section of wire management channel provided per table
- Pull-Out Waste/Recycling Bin size: 14" x 10-1/2" x 18"
- Only Woodgrain Laminate options are available for the Racetrack Base
- Racetrack Bases have a removable access door

### REQUIRED INFORMATION (ORDER CANNOT BE ENTERED WITHOUT THIS INFORMATION)

See appendix pages vi-vii for surface material options.

- Choose Solid Surface Finish
- Choose Veneer Finish, if applicable
- Choose Paint Finish if -PA is specified
- Choose Metal Finish
- Choose ABS Finish or Coordinating Woodgrain Edgeband finish if -RCL base specified



# VENEER TOP WITH HARDWOOD EDGE / VENEER CASE



D-SHAPE TOP

### BASE KEY

OF	Open Frame	RCL	Laminate Racetrack Base
ML	Post Metal Leg	RCP	Painted Racetrack Base
		RCV	Veneer Racetrack Base

## D-SHAPE TOP // 72" CREDENZA BASE // SEATED HEIGHT

MODEL #	LENGTH	WIDTH	HEIGHT	CREDENZA BASE	SEATING CAPACITY	-OF	-ML	-RCL	-RCP	-RCV
TFX-3060-V	60	30	29-1/2	72	3	9,356	9,356	-	-	-
TFX-3660-V	60	36	29-1/2	72	3	9,560	9,560	-	-	-
TFX-4260-V	60	42	29-1/2	72	3	10,617	10,617	-	-	-
TFX-4860-V	60	48	29-1/2	72	3	11,212	11,212	-	-	-
TFX-3066-V	66	30	29-1/2	72	3	10,012	10,012	-	-	-
TFX-3666-V	66	36	29-1/2	72	3	10,249	10,249	-	-	-
TFX-4266-V	66	42	29-1/2	72	3	11,402	11,402	-	-	-
TFX-4866-V	66	48	29-1/2	72	3	12,061	12,061	-	-	-
TFX-3072-V	72	30	29-1/2	72	3	10,147	10,147	-	-	-
TFX-3672-V	72	36	29-1/2	72	3	10,405	10,405	-	-	-
TFX-4272-V	72	42	29-1/2	72	3	11,595	11,595	11,595	12,162	12,817
TFX-4872-V	72	48	29-1/2	72	3	12,285	12,285	12,285	12,872	13,549
TFX-3078-V	78	30	29-1/2	72	5	10,995	10,995	-	-	-
TFX-3678-V	78	36	29-1/2	72	5	11,294	11,294	-	-	-
TFX-4278-V	78	42	29-1/2	72	5	12,607	12,607	12,607	13,213	13,913
TFX-4878-V	78	48	29-1/2	72	5	13,378	13,378	13,378	14,005	14,729
TFX-3084-V	84	30	29-1/2	72	5	11,140	11,140	-	-	-
TFX-3684-V	84	36	29-1/2	72	5	11,462	11,462	-	-	-
TFX-4284-V	84	42	29-1/2	72	5	12,814	12,814	12,814	13,420	14,120
TFX-4884-V	84	48	29-1/2	72	5	13,618	13,618	13,618	14,245	14,969
TFX-3090-V	90	30	29-1/2	72	5	11,870	11,870	-	-	-
TFX-3690-V	90	36	29-1/2	72	5	12,233	12,233	-	-	-
TFX-4290-V	90	42	29-1/2	72	5	13,697	13,697	13,697	14,335	15,071
TFX-4890-V	90	48	29-1/2	72	5	14,578	14,578	14,578	15,237	15,999
TFX-3096-V	96	30	29-1/2	72	5	12,022	12,022	-	-	-
TFX-3696-V	96	36	29-1/2	72	5	12,409	12,409	-	-	-
TFX-4296-V	96	42	29-1/2	72	5	13,914	13,914	13,914	14,552	15,289
TFX-4896-V	96	48	29-1/2	72	5	14,829	14,829	14,829	15,489	16,251

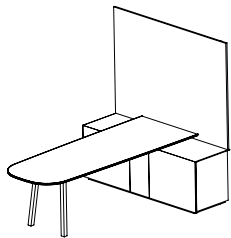

Shown with optional Monitor Panel (-MP)

### OPTIONS

Power & Data Options

See pages 121-131

#### Polished Chrome Finish Options:

Polished Chrome Open Frame Base	Add <b>-PCOF-TWA</b>	\$1,280
Polished Chrome Post Metal Legs	Add <b>-PCML-TWA</b>	\$590

#### Credenza Base Options:

72"-wide Monitor Panel	Add <b>-MP</b>	\$2,930
Pull-out Waste/Recycling Unit (Left End Opening)	Add <b>-TE</b>	\$479
Sliding Equipment Rack (Right End Opening)	Add <b>-R1</b>	\$3,455
Locks	Add <b>-L</b>	\$242

### EDGE PROFILE



Two4Six Cutback Edge

### GENERAL INFORMATION

- Tops are 1-1/8"-thick with 3/16"-thick hardwood edge band
- Seating capacity based on 27" per person
- Overall table height 29.5". Overall height 78" if Monitor Panel is specified.
- Standard with quarter cut veneer
- Pull-Out Waste/Recycling option is located on left side of unit if specified
- Sliding Equipment Rack is located on the right end of the unit if specified
- Adjustable shelves standard
- Access door on the credenza base standard with a lock
- All doors will be keyed alike if locks are specified
- Equipment Rack - 12RU with thermostatically controlled fan
- Thermostatically-controlled fan activates automatically at 87° F and turns off at 85° F
- Credenza base is 22"-deep, the Monitor Panel adds 2" making the depth 24"
- Plinth base is veneer and recessed 1" on all sides
- One section of wire management channel provided per table with Post Metal Leg and Open Frame Bases
- Pull-Out Waste/Recycling Bin size: 14" x 10-1/2" x 18"
- Only Woodgrain Laminate options are available for the Racetrack Base
- Racetrack Bases have a removable access door

#### REQUIRED INFORMATION (ORDER CANNOT BE ENTERED WITHOUT THIS INFORMATION)

See appendix pages vi-vii for surface material options.

- Choose Veneer Finish
- Choose Metal Finish, if -OF or -ML Base is specified (Clear Anodized (-CA) is an option on the Post Metal Leg only)
- Choose ABS Finish or Coordinating Woodgrain Edgeband finish if -RCL base specified



# INSET LAMINATE TOP WITH HARDWOOD EDGE / VENEER CASE



D-SHAPE TOP

**BASE KEY**

OF	Open Frame	RCL	Laminate Racetrack Base
ML	Post Metal Leg	RCP	Painted Racetrack Base
		RCV	Veneer Racetrack Base

**D-SHAPE TOP // 72" CREDENZA BASE // SEATED HEIGHT**

MODEL #	LENGTH	WIDTH	HEIGHT	CREDENZA BASE	SEATING CAPACITY	-OF	-ML	-RCL	-RCP	-RCV
TFX-3060-P	60	30	29-1/2	72	3	8,842	8,842	-	-	-
TFX-3660-P	60	36	29-1/2	72	3	9,035	9,035	-	-	-
TFX-4260-P	60	42	29-1/2	72	3	10,034	10,034	-	-	-
TFX-4860-P	60	48	29-1/2	72	3	10,596	10,596	-	-	-
TFX-3066-P	66	30	29-1/2	72	3	9,462	9,462	-	-	-
TFX-3666-P	66	36	29-1/2	72	3	9,686	9,686	-	-	-
TFX-4266-P	66	42	29-1/2	72	3	10,775	10,775	-	-	-
TFX-4866-P	66	48	29-1/2	72	3	11,398	11,398	-	-	-
TFX-3072-P	72	30	29-1/2	72	3	9,589	9,589	-	-	-
TFX-3672-P	72	36	29-1/2	72	3	9,833	9,833	-	-	-
TFX-4272-P	72	42	29-1/2	72	3	10,958	10,958	10,958	11,494	12,113
TFX-4872-P	72	48	29-1/2	72	3	11,610	11,610	11,610	12,165	12,804
TFX-3078-P	78	30	29-1/2	72	5	10,391	10,391	-	-	-
TFX-3678-P	78	36	29-1/2	72	5	10,673	10,673	-	-	-
TFX-4278-P	78	42	29-1/2	72	5	11,914	11,914	11,914	12,487	13,148
TFX-4878-P	78	48	29-1/2	72	5	12,643	12,643	12,643	13,235	13,919
TFX-3084-P	84	30	29-1/2	72	5	10,528	10,528	-	-	-
TFX-3684-P	84	36	29-1/2	72	5	10,832	10,832	-	-	-
TFX-4284-P	84	42	29-1/2	72	5	12,110	12,110	12,110	12,682	13,344
TFX-4884-P	84	48	29-1/2	72	5	12,870	12,870	12,870	13,462	14,146
TFX-3090-P	90	30	29-1/2	72	5	11,218	11,218	-	-	-
TFX-3690-P	90	36	29-1/2	72	5	11,561	11,561	-	-	-
TFX-4290-P	90	42	29-1/2	72	5	12,944	12,944	12,944	13,547	14,243
TFX-4890-P	90	48	29-1/2	72	5	13,777	13,777	13,777	14,399	15,120
TFX-3096-P	96	30	29-1/2	72	5	11,361	11,361	-	-	-
TFX-3696-P	96	36	29-1/2	72	5	11,727	11,727	-	-	-
TFX-4296-P	96	42	29-1/2	72	5	13,149	13,149	13,149	13,752	14,449
TFX-4896-P	96	48	29-1/2	72	5	14,014	14,014	14,014	14,638	15,358

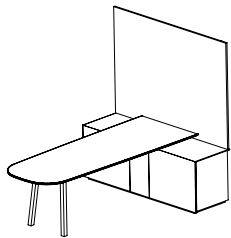

Shown with optional Monitor Panel (-MP)

**OPTIONS**

Power & Data Options

See pages 121-131

**Polished Chrome Finish Options:**

Polished Chrome Open Frame Base	Add -PCOF-TWA	\$1,280
Polished Chrome Post Metal Legs	Add -PCML-TWA	\$590

**Credenza Base Options:**

72"-wide Monitor Panel	Add -MP	\$2,930
Pull-out Waste/Recycling Unit (Left End Opening)	Add -TE	\$479
Sliding Equipment Rack (Right End Opening)	Add -R1	\$3,455
Locks	Add -L	\$242

**EDGE PROFILE**

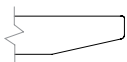

Two4Six Cutback Edge

**GENERAL INFORMATION**

- Tops are 1-1/8"-thick
- Seating capacity based on 27" per person
- Overall table height 29.5". Overall height 78" if Monitor Panel is specified.
- Standard with quarter cut veneer
- Pull-Out Waste/Recycling option is located on left side of unit if specified
- Sliding Equipment Rack is located on the right end of the unit if specified
- Adjustable shelves standard
- Access door on the credenza base standard with a lock
- All doors will be keyed alike if locks are specified
- Equipment Rack - 12RU with thermostatically controlled fan
- Thermostatically-controlled fan activates automatically at 87° F and turns off at 85° F
- Credenza base is 22"-deep, the Monitor Panel adds 2" making the depth 24"
- Plinth base is veneer and recessed 1" on all sides
- One section of wire management channel provided per table with Post Metal Leg and Open Frame Bases
- Pull-Out Waste/Recycling Bin size: 14" x 10-1/2" x 18"
- Only Woodgrain Laminate options are available for the Racetrack Base
- Racetrack Bases have a removable access door

**REQUIRED INFORMATION (ORDER CANNOT BE ENTERED WITHOUT THIS INFORMATION)**

See appendix pages vi-vii for surface material options.

- Choose Laminate Finish
- Choose Wood Species & Finish for Hardwood Edge
- Choose Veneer Finish
- Choose Metal Finish, if -OF or -ML Base is specified (Clear Anodized (-CA) is an option on the Post Metal Leg only)
- Choose ABS Finish or Coordinating Woodgrain Edgeband finish if -RCL base specified



# LAMINATE TOP WITH ABS CUTBACK EDGE / VENEER CASE



D-SHAPE TOP

### BASE KEY

OF	Open Frame	RCL	Laminate Racetrack Base
ML	Post Metal Leg	RCP	Painted Racetrack Base
		RCV	Veneer Racetrack Base

## D-SHAPE TOP // 72" CREDENZA BASE // SEATED HEIGHT

MODEL #	LENGTH	WIDTH	HEIGHT	CREDENZA BASE	SEATING CAPACITY	-OF	-ML	-RCL	-RCP	-RCV
TFX-3060-PA	60	30	29-1/2	72	3	8,842	8,842	-	-	-
TFX-3660-PA	60	36	29-1/2	72	3	9,035	9,035	-	-	-
TFX-4260-PA	60	42	29-1/2	72	3	10,034	10,034	-	-	-
TFX-4860-PA	60	48	29-1/2	72	3	10,596	10,596	-	-	-
TFX-3066-PA	66	30	29-1/2	72	3	9,462	9,462	-	-	-
TFX-3666-PA	66	36	29-1/2	72	3	9,686	9,686	-	-	-
TFX-4266-PA	66	42	29-1/2	72	3	10,775	10,775	-	-	-
TFX-4866-PA	66	48	29-1/2	72	3	11,398	11,398	-	-	-
TFX-3072-PA	72	30	29-1/2	72	3	9,589	9,589	-	-	-
TFX-3672-PA	72	36	29-1/2	72	3	9,833	9,833	-	-	-
TFX-4272-PA	72	42	29-1/2	72	3	10,958	10,958	10,958	11,494	12,113
TFX-4872-PA	72	48	29-1/2	72	3	11,610	11,610	11,610	12,165	12,804
TFX-3078-PA	78	30	29-1/2	72	5	10,391	10,391	-	-	-
TFX-3678-PA	78	36	29-1/2	72	5	10,673	10,673	-	-	-
TFX-4278-PA	78	42	29-1/2	72	5	11,914	11,914	11,914	12,487	13,148
TFX-4878-PA	78	48	29-1/2	72	5	12,643	12,643	12,643	13,235	13,919
TFX-3084-PA	84	30	29-1/2	72	5	10,528	10,528	-	-	-
TFX-3684-PA	84	36	29-1/2	72	5	10,832	10,832	-	-	-
TFX-4284-PA	84	42	29-1/2	72	5	12,110	12,110	12,110	12,682	13,344
TFX-4884-PA	84	48	29-1/2	72	5	12,870	12,870	12,870	13,462	14,146
TFX-3090-PA	90	30	29-1/2	72	5	11,218	11,218	-	-	-
TFX-3690-PA	90	36	29-1/2	72	5	11,561	11,561	-	-	-
TFX-4290-PA	90	42	29-1/2	72	5	12,944	12,944	12,944	13,547	14,243
TFX-4890-PA	90	48	29-1/2	72	5	13,777	13,777	13,777	14,399	15,120
TFX-3096-PA	96	30	29-1/2	72	5	11,361	11,361	-	-	-
TFX-3696-PA	96	36	29-1/2	72	5	11,727	11,727	-	-	-
TFX-4296-PA	96	42	29-1/2	72	5	13,149	13,149	13,149	13,752	14,449
TFX-4896-PA	96	48	29-1/2	72	5	14,014	14,014	14,014	14,638	15,358

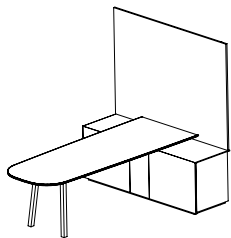

Shown with optional Monitor Panel (-MP)

### OPTIONS

Power & Data Options

See pages 121-131

#### Polished Chrome Finish Options:

Polished Chrome Open Frame Base	Add -PCOF-TWA	\$1,280
Polished Chrome Post Metal Legs	Add -PCML-TWA	\$590

#### Credenza Base Options:

72"-wide Monitor Panel	Add -MP	\$2,930
Pull-out Waste/Recycling Unit (Left End Opening)	Add -TE	\$479
Sliding Equipment Rack (Right End Opening)	Add -R1	\$3,455
Locks	Add -L	\$242

### EDGE PROFILE

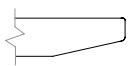

Two4Six Cutback Edge

### GENERAL INFORMATION

- Tops are 1-1/8"-thick
- Seating capacity based on 27" per person
- Overall table height 29.5". Overall height 78" if Monitor Panel is specified.
- Standard with quarter cut veneer
- Pull-Out Waste/Recycling option is located on left side of unit if specified
- Sliding Equipment Rack is located on the right end of the unit if specified
- Adjustable shelves standard
- Access door on the credenza base standard with a lock
- All doors will be keyed alike if locks are specified
- Equipment Rack - 12RU with thermostatically controlled fan
- Thermostatically-controlled fan activates automatically at 87° F and turns off at 85° F
- Credenza base is 22"-deep, the Monitor Panel adds 2" making the depth 24"
- Plinth base is veneer and recessed 1" on all sides
- One section of wire management channel provided per table with Post Metal Leg and Open Frame Bases
- Pull-Out Waste/Recycling Bin size: 14" x 10-1/2" x 18"
- Only Woodgrain Laminate options are available for the Racetrack Base
- Racetrack Bases have a removable access door

#### REQUIRED INFORMATION (ORDER CANNOT BE ENTERED WITHOUT THIS INFORMATION)

See appendix pages vi-vii for surface material options.

- Choose Laminate Finish
- Choose ABS Edge Finish or Coordinating Woodgrain Edgeband finish
- Choose Veneer Finish
- Choose Metal Finish, if -OF or -ML Base is specified (Clear Anodized (-CA) is an option on the Post Metal Leg only)





# LAMINATE TOP WITH ABS SQUARE EDGE / VENEER CASE



D-SHAPE TOP

**BASE KEY**

OF	Open Frame	RCL	Laminate Racetrack Base
ML	Post Metal Leg	RCP	Painted Racetrack Base
		RCV	Veneer Racetrack Base

**D-SHAPE TOP // 72" CREDENZA BASE // SEATED HEIGHT**

MODEL #	LENGTH	WIDTH	HEIGHT	CREDENZA BASE	SEATING CAPACITY	-OF	-ML	-RCL	-RCP	-RCV
TFX-3060-PE	60	30	29-1/2	72	3	8,402	8,402	-	-	-
TFX-3660-PE	60	36	29-1/2	72	3	8,585	8,585	-	-	-
TFX-4260-PE	60	42	29-1/2	72	3	9,535	9,535	-	-	-
TFX-4860-PE	60	48	29-1/2	72	3	10,069	10,069	-	-	-
TFX-3066-PE	66	30	29-1/2	72	3	8,991	8,991	-	-	-
TFX-3666-PE	66	36	29-1/2	72	3	9,204	9,204	-	-	-
TFX-4266-PE	66	42	29-1/2	72	3	10,239	10,239	-	-	-
TFX-4866-PE	66	48	29-1/2	72	3	10,831	10,831	-	-	-
TFX-3072-PE	72	30	29-1/2	72	3	9,113	9,113	-	-	-
TFX-3672-PE	72	36	29-1/2	72	3	9,344	9,344	-	-	-
TFX-4272-PE	72	42	29-1/2	72	3	10,413	10,413	10,413	10,922	11,510
TFX-4872-PE	72	48	29-1/2	72	3	11,032	11,032	11,032	11,560	12,168
TFX-3078-PE	78	30	29-1/2	72	5	9,874	9,874	-	-	-
TFX-3678-PE	78	36	29-1/2	72	5	10,143	10,143	-	-	-
TFX-4278-PE	78	42	29-1/2	72	5	11,322	11,322	11,322	11,866	12,494
TFX-4878-PE	78	48	29-1/2	72	5	12,014	12,014	12,014	12,577	13,227
TFX-3084-PE	84	30	29-1/2	72	5	10,004	10,004	-	-	-
TFX-3684-PE	84	36	29-1/2	72	5	10,293	10,293	-	-	-
TFX-4284-PE	84	42	29-1/2	72	5	11,507	11,507	11,507	12,052	12,680
TFX-4884-PE	84	48	29-1/2	72	5	12,229	12,229	12,229	12,793	13,443
TFX-3090-PE	90	30	29-1/2	72	5	10,660	10,660	-	-	-
TFX-3690-PE	90	36	29-1/2	72	5	10,986	10,986	-	-	-
TFX-4290-PE	90	42	29-1/2	72	5	12,300	12,300	12,300	12,873	13,534
TFX-4890-PE	90	48	29-1/2	72	5	13,092	13,092	13,092	13,683	14,368
TFX-3096-PE	96	30	29-1/2	72	5	10,796	10,796	-	-	-
TFX-3696-PE	96	36	29-1/2	72	5	11,144	11,144	-	-	-
TFX-4296-PE	96	42	29-1/2	72	5	12,495	12,495	12,495	13,068	13,730
TFX-4896-PE	96	48	29-1/2	72	5	13,317	13,317	13,317	13,910	14,594

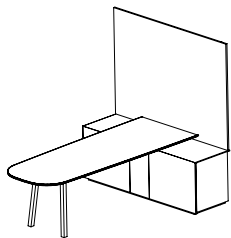

Shown with optional Monitor Panel (-MP)

**OPTIONS**

Power & Data Options

See pages 121-131

**Polished Chrome Finish Options:**

Polished Chrome Open Frame Base	Add -PCOF-TWA	\$1,280
Polished Chrome Post Metal Legs	Add -PCML-TWA	\$590

**Credenza Base Options:**

72"-wide Monitor Panel	Add -MP	\$2,930
Pull-out Waste/Recycling Unit (Left End Opening)	Add -TE	\$479
Sliding Equipment Rack (Right End Opening)	Add -R1	\$3,455
Locks	Add -L	\$242

**GENERAL INFORMATION**

- Tops are 1-1/8"-thick
- Seating capacity based on 27" per person
- Overall table height 29.5". Overall height 78" if Monitor Panel is specified.
- Standard with quarter cut veneer
- Pull-Out Waste/Recycling option is located on left side of unit if specified
- Sliding Equipment Rack is located on the right end of the unit if specified
- Adjustable shelves standard
- Access door on the credenza base standard with a lock
- All doors will be keyed alike if locks are specified
- Equipment Rack - 12RU with thermostatically controlled fan
- Thermostatically-controlled fan activates automatically at 87° F and turns off at 85° F
- Credenza base is 22"-deep, the Monitor Panel adds 2" making the depth 24"
- Plinth base is veneer and recessed 1" on all sides
- One section of wire management channel provided per table with Post Metal Leg and Open Frame Bases
- Pull-Out Waste/Recycling Bin size: 14" x 10-1/2" x 18"
- Only Woodgrain Laminate options are available for the Racetrack Base
- Racetrack Bases have a removable access door

**REQUIRED INFORMATION (ORDER CANNOT BE ENTERED WITHOUT THIS INFORMATION)**

See appendix pages vi-vii for surface material options.

- Choose Laminate Finish
- Choose ABS Edge Finish or Coordinating Woodgrain Edgeband finish
- Choose Veneer Finish
- Choose Metal Finish, if -OF or -ML Base is specified (Clear Anodized (-CA) is an option on the Post Metal Leg only)

**EDGE PROFILE**



Two4Six Square Edge



# GLASS TOP / VENEER CASE



D-SHAPE TOP

### BASE KEY

OF Open Frame

RCL Laminate Racetrack Base  
RCP Painted Racetrack Base  
RCV Veneer Racetrack Base

## D-SHAPE TOP // 72" CREDENZA BASE // SEATED HEIGHT

MODEL #	LENGTH	WIDTH	HEIGHT	CREDENZA BASE	SEATING CAPACITY	-OF	-RCL	-RCP	-RCV
TFX-3060-G	60	30	29-1/2	72	3	14,596	-	-	-
TFX-3660-G	60	36	29-1/2	72	3	14,914	-	-	-
TFX-4260-G	60	42	29-1/2	72	3	16,563	-	-	-
TFX-4860-G	60	48	29-1/2	72	3	17,491	-	-	-
TFX-3066-G	66	30	29-1/2	72	3	15,619	-	-	-
TFX-3666-G	66	36	29-1/2	72	3	15,989	-	-	-
TFX-4266-G	66	42	29-1/2	72	3	17,788	-	-	-
TFX-4866-G	66	48	29-1/2	72	3	18,816	-	-	-
TFX-3072-G	72	30	29-1/2	72	3	15,830	-	-	-
TFX-3672-G	72	36	29-1/2	72	3	16,232	-	-	-
TFX-4272-G	72	42	29-1/2	72	3	18,089	18,089	18,973	19,995
TFX-4872-G	72	48	29-1/2	72	3	19,165	19,165	20,081	21,137
TFX-3078-G	78	30	29-1/2	72	5	17,153	-	-	-
TFX-3678-G	78	36	29-1/2	72	5	17,619	-	-	-
TFX-4278-G	78	42	29-1/2	72	5	19,667	19,667	20,613	21,705
TFX-4878-G	78	48	29-1/2	72	5	20,870	20,870	21,848	22,978
TFX-3084-G	84	30	29-1/2	72	5	17,379	-	-	-
TFX-3684-G	84	36	29-1/2	72	5	17,881	-	-	-
TFX-4284-G	84	42	29-1/2	72	5	19,990	19,990	20,936	22,028
TFX-4884-G	84	48	29-1/2	72	5	21,245	21,245	22,223	23,352
TFX-3090-G	90	30	29-1/2	72	5	18,518	-	-	-
TFX-3690-G	90	36	29-1/2	72	5	19,084	-	-	-
TFX-4290-G	90	42	29-1/2	72	5	21,368	21,368	22,363	23,511
TFX-4890-G	90	48	29-1/2	72	5	22,742	22,742	23,770	24,959
TFX-3096-G	96	30	29-1/2	72	5	18,755	-	-	-
TFX-3696-G	96	36	29-1/2	72	5	19,359	-	-	-
TFX-4296-G	96	42	29-1/2	72	5	21,706	21,706	22,702	23,851
TFX-4896-G	96	48	29-1/2	72	5	23,134	23,134	24,163	25,352

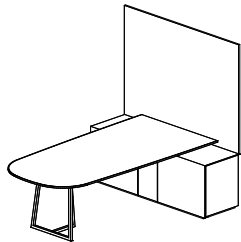

Shown with optional Monitor Panel (-MP)

### OPTIONS

Power & Data Options

See pages 121-131

#### Polished Chrome Finish Options:

Polished Chrome Open Frame Base Add **-PCOF-TWA** \$1,280

#### Satin Glass Options:

Satin Glass Add **-TFSG** \$661

#### Credenza Base Options:

72"-wide Monitor Panel Add **-MP** \$2,930  
 Pull-out Waste/Recycling Unit (Left End Opening) Add **-TE** \$479  
 Sliding Equipment Rack (Right End Opening) Add **-R1** \$3,455  
 Locks Add **-L** \$242

### CODE

### PRICE

### NOTES

### EDGE PROFILE

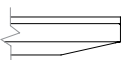

Two4Six Glass Edge

### GENERAL INFORMATION

- Tops are 1-1/8"-thick
- Seating capacity based on 27" per person
- Overall table height 29.5". Overall height 78" if Monitor Panel is specified.
- Standard with quarter cut veneer
- Pull-Out Waste/Recycling option is located on left side of unit if specified
- Sliding Equipment Rack is located on the right end of the unit if specified
- Adjustable shelves standard
- Access door on the credenza base standard with a lock
- All doors will be keyed alike if locks are specified
- Equipment Rack - 12RU with thermostatically controlled fan
- Thermostatically-controlled fan activates automatically at 87° F and turns off at 85° F
- Credenza base is 22"-deep, the Monitor Panel adds 2" making the depth 24"
- Plinth base is veneer and recessed 1" on all sides
- One section of wire management channel provided per table with Post Metal Leg and Open Frame Bases
- Pull-Out Waste/Recycling Bin size: 14" x 10-1/2" x 18"
- Only Woodgrain Laminate options are available for the Racetrack Base
- Racetrack Bases have a removable access door

### REQUIRED INFORMATION (ORDER CANNOT BE ENTERED WITHOUT THIS INFORMATION)

See appendix pages vi-vii for surface material options.

- Choose Glass Finish
- Choose Veneer Finish, if applicable
- Choose Paint Finish if -PA is specified
- Choose Metal Finish
- Choose ABS Finish or Coordinating Woodgrain Edgeband finish if -RCL base specified
- Choose Sub-Top Finish: Paint Finish or Wood Species & Finish



# SOLID SURFACE TOP / VENEER CASE



D-SHAPE TOP

**BASE KEY**

OF Open Frame

RCL Laminate Racetrack Base  
RCP Painted Racetrack Base  
RCV Veneer Racetrack Base

**D-SHAPE TOP // 72" CREDENZA BASE // SEATED HEIGHT**

MODEL #	LENGTH	WIDTH	HEIGHT	CREDENZA BASE	SEATING CAPACITY	-OF	-RCL	-RCP	-RCV
TFX-3060-SS	60	30	29-1/2	72	3	15,251	-	-	-
TFX-3660-SS	60	36	29-1/2	72	3	15,583	-	-	-
TFX-4260-SS	60	42	29-1/2	72	3	17,306	-	-	-
TFX-4860-SS	60	48	29-1/2	72	3	18,276	-	-	-
TFX-3066-SS	66	30	29-1/2	72	3	16,320	-	-	-
TFX-3666-SS	66	36	29-1/2	72	3	16,706	-	-	-
TFX-4266-SS	66	42	29-1/2	72	3	18,586	-	-	-
TFX-4866-SS	66	48	29-1/2	72	3	19,660	-	-	-
TFX-3072-SS	72	30	29-1/2	72	3	16,540	-	-	-
TFX-3672-SS	72	36	29-1/2	72	3	16,961	-	-	-
TFX-4272-SS	72	42	29-1/2	72	3	18,900	18,900	19,825	20,892
TFX-4872-SS	72	48	29-1/2	72	3	20,025	20,025	20,982	22,085
TFX-3078-SS	78	30	29-1/2	72	5	17,922	-	-	-
TFX-3678-SS	78	36	29-1/2	72	5	18,410	-	-	-
TFX-4278-SS	78	42	29-1/2	72	5	20,550	20,550	21,538	22,679
TFX-4878-SS	78	48	29-1/2	72	5	21,807	21,807	22,829	24,009
TFX-3084-SS	84	30	29-1/2	72	5	18,159	-	-	-
TFX-3684-SS	84	36	29-1/2	72	5	18,684	-	-	-
TFX-4284-SS	84	42	29-1/2	72	5	20,887	20,887	21,875	23,016
TFX-4884-SS	84	48	29-1/2	72	5	22,198	22,198	23,220	24,400
TFX-3090-SS	90	30	29-1/2	72	5	19,349	-	-	-
TFX-3690-SS	90	36	29-1/2	72	5	19,940	-	-	-
TFX-4290-SS	90	42	29-1/2	72	5	22,327	22,327	23,367	24,566
TFX-4890-SS	90	48	29-1/2	72	5	23,763	23,763	24,837	26,079
TFX-3096-SS	96	30	29-1/2	72	5	19,596	-	-	-
TFX-3696-SS	96	36	29-1/2	72	5	20,227	-	-	-
TFX-4296-SS	96	42	29-1/2	72	5	22,680	22,680	23,720	24,922
TFX-4896-SS	96	48	29-1/2	72	5	24,172	24,172	25,248	26,490

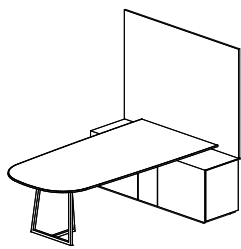

Shown with optional Monitor Panel (-MP)

**OPTIONS**

Power & Data Options

See pages 121-131

**Polished Chrome Finish Options:**

Polished Chrome Open Frame Base Add **-PCOF-TWA** \$1,280

**Credenza Base Options:**

72"-wide Monitor Panel Add **-MP** \$2,930  
 Pull-out Waste/Recycling Unit (Left End Opening) Add **-TE** \$479  
 Sliding Equipment Rack (Right End Opening) Add **-R1** \$3,455  
 Locks Add **-L** \$242

**EDGE PROFILE**



Two4Six Solid Surface Edge

**GENERAL INFORMATION**

- Seating capacity based on 27" per person
- Overall table height 29.5". Overall height 78" if Monitor Panel is specified.
- Standard with quarter cut veneer
- Pull-Out Waste/Recycling option is located on left side of unit if specified
- Sliding Equipment Rack is located on the right end of the unit if specified
- Adjustable shelves standard
- Access door on the credenza base standard with a lock.
- All doors will be keyed alike if locks are specified.
- Equipment Rack - 12RU with thermostatically controlled fan
- Thermostatically-controlled fan activates automatically at 87° F and turns off at 85° F
- Credenza base is 22"-deep, the Monitor Panel adds 2" making the depth 4"
- Plinth base is veneer and recessed 1" on all sides
- One section of wire management channel provided per table with Post Metal Leg and Open Frame Bases
- Pull-Out Waste/Recycling Bin size: 14" x 10-1/2" x 18"
- Only Woodgrain Laminate options are available for the Racetrack Base
- Racetrack Bases have a removable access door

**REQUIRED INFORMATION (ORDER CANNOT BE ENTERED WITHOUT THIS INFORMATION)**

See appendix pages vi-vii for surface material options.

- Choose Solid Surface Finish
- Choose Veneer Finish, if applicable
- Choose Paint Finish if -PA is specified
- Choose Metal Finish
- Choose ABS Finish or Coordinating Woodgrain Edgeband finish if -RCL base specified



# VENEER TOP WITH HARDWOOD EDGE



D-SHAPE TOP

### BASE KEY

OF	Open Frame	RCL	Laminate Racetrack Base
ML	Post Metal Leg	RCP	Painted Racetrack Base
		RCV	Veneer Racetrack Base

## D-SHAPE TOP // SLAB BASE // SEATED HEIGHT

MODEL #	LENGTH	WIDTH	HEIGHT	SEATING CAPACITY	-OF	-ML	-RCL	-RCP	-RCV
TFE-3060-V [ ]	60	30	29-1/2	4	3,930	3,930	-	-	-
TFE-3066-V [ ]	66	30	29-1/2	5	4,283	4,283	-	-	-
TFE-3072-V [ ]	72	30	29-1/2	5	4,419	4,419	-	-	-
TFE-3078-V [ ]	78	30	29-1/2	5	4,869	4,869	-	-	-
TFE-3084-V [ ]	84	30	29-1/2	7	5,014	5,014	-	-	-
TFE-3090-V [ ]	90	30	29-1/2	7	5,425	5,425	-	-	-
TFE-3096-V [ ]	96	30	29-1/2	7	5,577	5,577	-	-	-
TFE-3660-V [ ]	60	36	29-1/2	5	4,134	4,134	-	-	-
TFE-3666-V [ ]	66	36	29-1/2	5	4,520	4,520	-	-	-
TFE-3672-V [ ]	72	36	29-1/2	5	4,677	4,677	-	-	-
TFE-3678-V [ ]	78	36	29-1/2	5	5,168	5,168	-	-	-
TFE-3684-V [ ]	84	36	29-1/2	7	5,336	5,336	-	-	-
TFE-3690-V [ ]	90	36	29-1/2	7	5,788	5,788	-	-	-
TFE-3696-V [ ]	96	36	29-1/2	7	5,964	5,964	-	-	-
TFE-4260-V [ ]	60	42	29-1/2	5	4,717	4,717	-	-	-
TFE-4266-V [ ]	66	42	29-1/2	5	5,172	5,172	-	-	-
TFE-4272-V [ ]	72	42	29-1/2	5	5,366	5,366	5,366	5,616	5,898
TFE-4278-V [ ]	78	42	29-1/2	5	5,945	5,945	5,945	6,213	6,514
TFE-4284-V [ ]	84	42	29-1/2	7	6,152	6,152	6,152	6,420	6,721
TFE-4290-V [ ]	90	42	29-1/2	7	6,689	6,689	6,689	6,970	7,288
TFE-4296-V [ ]	96	42	29-1/2	7	6,906	6,906	6,906	7,188	7,505
TFE-4860-V [ ]	60	48	29-1/2	5	5,107	5,107	-	-	-
TFE-4866-V [ ]	66	48	29-1/2	5	5,617	5,617	-	-	-
TFE-4872-V [ ]	72	48	29-1/2	5	5,841	5,841	5,841	6,100	6,392
TFE-4878-V [ ]	78	48	29-1/2	7	6,486	6,486	6,486	6,763	7,075
TFE-4884-V [ ]	84	48	29-1/2	7	6,726	6,726	6,726	7,003	7,315
TFE-4890-V [ ]	90	48	29-1/2	7	7,328	7,328	7,328	7,619	7,947
TFE-4896-V [ ]	96	48	29-1/2	7	7,580	7,580	7,580	7,871	8,199

[ ] Slab Base, Specify Paint (-PS) or Veneer (-V)

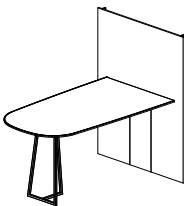

Shown with optional Monitor Panel (-MP)

OPTIONS	CODE	PRICE	NOTES
Power & Data Options			See pages 121-131
Remove Slab Base	Add <b>-WM</b>	Deduct \$699	Mounted directly to wall
<b>Polished Chrome Finish Options:</b>			
Polished Chrome Open Frame Base	Add <b>-PCOF-TWA</b>	\$1,280	
Polished Chrome Post Metal Legs	Add <b>-PCML-TWA</b>	\$590	
<b>Monitor Panel Options:</b>			
42"-Wide Monitor Panel	Add <b>-MP30</b>	\$2,076	For use with 30"-Wide Tables
48"-Wide Monitor Panel	Add <b>-MP36</b>	\$2,288	For use with 36"-Wide Tables
54"-Wide Monitor Panel	Add <b>-MP42</b>	\$2,502	For use with 42"-Wide Tables
60"-Wide Monitor Panel	Add <b>-MP48</b>	\$2,717	For use with 48"-Wide Tables

### EDGE PROFILE



Two4Six Cutback Edge

### GENERAL INFORMATION

- Tops are 1-1/8"-thick with 3/16"-thick hardwood edge band
- Seating capacity based on 27" per person
- Overall table height 29.5"
- Standard with quarter cut veneer
- Must be anchored to a wall, with or without Slab Base
- One section of wire management channel provided per table with Post Metal Leg and Open Frame Bases
- Monitor Panel will be 12" wider than the table specified
- Monitor Panel mounts directly to the wall
- Monitor Panel is 78" high
- Only Woodgrain Laminate options are available for the Racetrack Base
- Racetrack Bases have a removable access door

### REQUIRED INFORMATION (ORDER CANNOT BE ENTERED WITHOUT THIS INFORMATION)

- See appendix pages vi-vii for surface material options.
- Choose Veneer Finish. If -V option is specified for the Slab Base, the finish will be the same as the table top.
    - Choose Paint Finish, if -PS Slab Base is specified
    - Choose Metal Finish, if -OF or -ML Base is specified (Clear Anodized (-CA) is an option on the Post Metal Leg only)
    - Choose ABS Finish or Coordinating Woodgrain Edgeband finish if -RCL base specified



# INSET LAMINATE TOP WITH HARDWOOD EDGE



D-SHAPE TOP

**BASE KEY**

OF	Open Frame	RCL	Laminate Racetrack Base
ML	Post Metal Leg	RCP	Painted Racetrack Base
		RCV	Veneer Racetrack Base

**D-SHAPE TOP // SLAB BASE // SEATED HEIGHT**

MODEL #	LENGTH	WIDTH	HEIGHT	SEATING CAPACITY	-OF	-ML	-RCL	-RCP	-RCV
TFE-3060-P [ ]	60	30	29-1/2	4	3,714	3,714	-	-	-
TFE-3066-P [ ]	66	30	29-1/2	5	4,048	4,048	-	-	-
TFE-3072-P [ ]	72	30	29-1/2	5	4,176	4,176	-	-	-
TFE-3078-P [ ]	78	30	29-1/2	5	4,602	4,602	-	-	-
TFE-3084-P [ ]	84	30	29-1/2	7	4,739	4,739	-	-	-
TFE-3090-P [ ]	90	30	29-1/2	7	5,127	5,127	-	-	-
TFE-3096-P [ ]	96	30	29-1/2	7	5,271	5,271	-	-	-
TFE-3660-P [ ]	60	36	29-1/2	5	3,907	3,907	-	-	-
TFE-3666-P [ ]	66	36	29-1/2	5	4,272	4,272	-	-	-
TFE-3672-P [ ]	72	36	29-1/2	5	4,420	4,420	-	-	-
TFE-3678-P [ ]	78	36	29-1/2	5	4,884	4,884	-	-	-
TFE-3684-P [ ]	84	36	29-1/2	7	5,043	5,043	-	-	-
TFE-3690-P [ ]	90	36	29-1/2	7	5,470	5,470	-	-	-
TFE-3696-P [ ]	96	36	29-1/2	7	5,636	5,636	-	-	-
TFE-4260-P [ ]	60	42	29-1/2	5	4,458	4,458	-	-	-
TFE-4266-P [ ]	66	42	29-1/2	5	4,888	4,888	-	-	-
TFE-4272-P [ ]	72	42	29-1/2	5	5,071	5,071	5,071	5,308	5,574
TFE-4278-P [ ]	78	42	29-1/2	5	5,619	5,619	5,619	5,872	6,156
TFE-4284-P [ ]	84	42	29-1/2	7	5,814	5,814	5,814	6,067	6,352
TFE-4290-P [ ]	90	42	29-1/2	7	6,322	6,322	6,322	6,587	6,888
TFE-4296-P [ ]	96	42	29-1/2	7	6,527	6,527	6,527	6,793	7,093
TFE-4860-P [ ]	60	48	29-1/2	5	4,827	4,827	-	-	-
TFE-4866-P [ ]	66	48	29-1/2	5	5,309	5,309	-	-	-
TFE-4872-P [ ]	72	48	29-1/2	5	5,520	5,520	5,520	5,765	6,041
TFE-4878-P [ ]	78	48	29-1/2	7	6,130	6,130	6,130	6,392	6,686
TFE-4884-P [ ]	84	48	29-1/2	7	6,357	6,357	6,357	6,618	6,913
TFE-4890-P [ ]	90	48	29-1/2	7	6,925	6,925	6,925	7,200	7,510
TFE-4896-P [ ]	96	48	29-1/2	7	7,164	7,164	7,164	7,439	7,749

[ ] Slab Base, Specify Paint (-PS) or Veneer (-V)

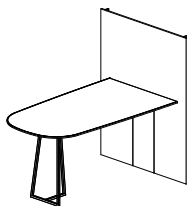

Shown with optional Monitor Panel (-MP)

**OPTIONS**

Power & Data Options

See pages 121-131

Remove Slab Base

Add **-WM**

Deduct \$699

Mounted directly to wall

**Polished Chrome Finish Options:**

Polished Chrome Open Frame Base

Add **-PCOF-TWA**

\$1,280

Polished Chrome Post Metal Legs

Add **-PCML-TWA**

\$590

**Monitor Panel Options:**

42"-Wide Monitor Panel

Add **-MP30**

\$2,076

For use with 30"-Wide Tables

48"-Wide Monitor Panel

Add **-MP36**

\$2,288

For use with 36"-Wide Tables

54"-Wide Monitor Panel

Add **-MP42**

\$2,502

For use with 42"-Wide Tables

60"-Wide Monitor Panel

Add **-MP48**

\$2,717

For use with 48"-Wide Tables

**EDGE PROFILE**



Two4Six Cutback Edge

**GENERAL INFORMATION**

- Tops are 1-1/8"-thick with 3/16"-thick hardwood edge band
- Seating capacity based on 27" per person
- Overall table height 29.5"
- Standard with quarter cut veneer
- Must be anchored to a wall, with or without Slab Base
- One section of wire management channel provided per table with Post Metal Leg and Open Frame Bases
- Monitor Panel will be 12" wider than the table specified
- Monitor Panel mounts directly to the wall
- Monitor Panel is 78" high
- Monitor panel available in Paint or Veneer Finish options only
- Only Woodgrain Laminate options are available for the Racetrack Base
- Racetrack Bases have a removable access door

**REQUIRED INFORMATION (ORDER CANNOT BE ENTERED WITHOUT THIS INFORMATION)**

See appendix pages vi-vii for surface material options.

- Choose Laminate Finish
- Choose Wood Species & Finish for Hardwood Edge
- Choose Paint Finish, if -PS Slab Base is specified
- Choose Veneer Finish, if -V Slab Base is specified
- Choose Metal Finish, if -OF or -ML Base is specified (Clear Anodized (-CA) is an option on the Post Metal Leg only)
- Choose ABS Finish or Coordinating Woodgrain Edgeband finish if -RCL base specified



# LAMINATE TOP WITH ABS CUTBACK EDGE



D-SHAPE TOP

### BASE KEY

OF	Open Frame	RCL	Laminate Racetrack Base
ML	Post Metal Leg	RCP	Painted Racetrack Base
		RCV	Veneer Racetrack Base

## D-SHAPE TOP // SLAB BASE // SEATED HEIGHT

MODEL #	LENGTH	WIDTH	HEIGHT	SEATING CAPACITY	-OF	-ML	-RCL	-RCP	-RCV
TFE-3060-PA [ ]	60	30	29-1/2	5	3,714	3,714	-	-	-
TFE-3066-PA [ ]	66	30	29-1/2	5	4,048	4,048	-	-	-
TFE-3072-PA [ ]	72	30	29-1/2	5	4,176	4,176	-	-	-
TFE-3078-PA [ ]	78	30	29-1/2	5	4,602	4,602	-	-	-
TFE-3084-PA [ ]	84	30	29-1/2	7	4,739	4,739	-	-	-
TFE-3090-PA [ ]	90	30	29-1/2	7	5,127	5,127	-	-	-
TFE-3096-PA [ ]	96	30	29-1/2	7	5,271	5,271	-	-	-
TFE-3660-PA [ ]	60	36	29-1/2	5	3,907	3,907	-	-	-
TFE-3666-PA [ ]	66	36	29-1/2	5	4,272	4,272	-	-	-
TFE-3672-PA [ ]	72	36	29-1/2	5	4,420	4,420	-	-	-
TFE-3678-PA [ ]	78	36	29-1/2	5	4,884	4,884	-	-	-
TFE-3684-PA [ ]	84	36	29-1/2	7	5,043	5,043	-	-	-
TFE-3690-PA [ ]	90	36	29-1/2	7	5,470	5,470	-	-	-
TFE-3696-PA [ ]	96	36	29-1/2	7	5,636	5,636	-	-	-
TFE-4260-PA [ ]	60	42	29-1/2	5	4,458	4,458	-	-	-
TFE-4266-PA [ ]	66	42	29-1/2	5	4,888	4,888	-	-	-
TFE-4272-PA [ ]	72	42	29-1/2	5	5,071	5,071	5,071	5,308	5,574
TFE-4278-PA [ ]	78	42	29-1/2	5	5,619	5,619	5,619	5,872	6,156
TFE-4284-PA [ ]	84	42	29-1/2	7	5,814	5,814	5,814	6,067	6,352
TFE-4290-PA [ ]	90	42	29-1/2	7	6,322	6,322	6,322	6,587	6,888
TFE-4296-PA [ ]	96	42	29-1/2	7	6,527	6,527	6,527	6,793	7,093
TFE-4860-PA [ ]	60	48	29-1/2	5	4,827	4,827	-	-	-
TFE-4866-PA [ ]	66	48	29-1/2	5	5,309	5,309	-	-	-
TFE-4872-PA [ ]	72	48	29-1/2	5	5,520	5,520	5,520	5,765	6,041
TFE-4878-PA [ ]	78	48	29-1/2	5	6,130	6,130	6,130	6,392	6,686
TFE-4884-PA [ ]	84	48	29-1/2	7	6,357	6,357	6,357	6,618	6,913
TFE-4890-PA [ ]	90	48	29-1/2	7	6,925	6,925	6,925	7,200	7,510
TFE-4896-PA [ ]	96	48	29-1/2	7	7,164	7,164	7,164	7,439	7,749

[ ] Slab Base, Specify Paint (-PS) or Veneer (-V)

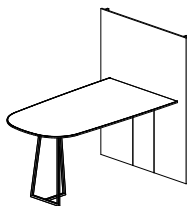

Shown with optional Monitor Panel (-MP)

### OPTIONS

Power & Data Options

See pages 121-131

Remove Slab Base

Add **-WM**

Deduct \$699

Mounted directly to wall

### Polished Chrome Finish Options:

Polished Chrome Open Frame Base

Add **-PCOF-TWA**

\$1,280

Polished Chrome Post Metal Legs

Add **-PCML-TWA**

\$590

### Monitor Panel Options:

42"-Wide Monitor Panel

Add **-MP30**

\$2,076

For use with 30"-Wide Tables

48"-Wide Monitor Panel

Add **-MP36**

\$2,288

For use with 36"-Wide Tables

54"-Wide Monitor Panel

Add **-MP42**

\$2,502

For use with 42"-Wide Tables

60"-Wide Monitor Panel

Add **-MP48**

\$2,717

For use with 48"-Wide Tables

### EDGE PROFILE

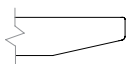

Two4Six Cutback Edge

### GENERAL INFORMATION

- Tops are 1-1/8"-thick with 3/16"-thick hardwood edge band
- Seating capacity based on 27" per person
- Overall table height 29.5"
- Standard with quarter cut veneer
- Must be anchored to a wall, with or without Slab Base
- One section of wire management channel provided per table with Post Metal Leg and Open Frame Bases

- Monitor Panel will be 12" wider than the table specified
- Monitor Panel mounts directly to the wall
- Monitor Panel is 78" high
- Monitor panel available in Paint or Veneer Finish options only
- Only Woodgrain Laminate options are available for the Racetrack Base
- Racetrack Bases have a removable access door

### REQUIRED INFORMATION (ORDER CANNOT BE ENTERED WITHOUT THIS INFORMATION)

See appendix pages vi-vii for surface material options.

- Choose Laminate Finish
- Choose ABS Edge Finish
- Choose Paint Finish, if -PS Slab Base is specified
- Choose Veneer Finish, if -V Slab Base is specified
- Choose Metal Finish, if -OF or -ML Base is specified (Clear Anodized (-CA) is an option on the Post Metal Leg only)
- Choose ABS Finish or Coordinating Woodgrain Edgeband finish if -RCL base specified



# LAMINATE TOP WITH ABS SQUARE EDGE



D-SHAPE TOP

### BASE KEY

OF	Open Frame	RCL	Laminate Racetrack Base
ML	Post Metal Leg	RCP	Painted Racetrack Base
		RCV	Veneer Racetrack Base

## D-SHAPE TOP // SLAB BASE // SEATED HEIGHT

MODEL #	LENGTH	WIDTH	HEIGHT	SEATING CAPACITY	-OF	-ML	-RCL	-RCP	-RCV
TFE-3060-PE [ ]	60	30	29-1/2	4	3,530	3,530	-	-	-
TFE-3066-PE [ ]	66	30	29-1/2	5	3,847	3,847	-	-	-
TFE-3072-PE [ ]	72	30	29-1/2	5	3,969	3,969	-	-	-
TFE-3078-PE [ ]	78	30	29-1/2	5	4,373	4,373	-	-	-
TFE-3084-PE [ ]	84	30	29-1/2	7	4,503	4,503	-	-	-
TFE-3090-PE [ ]	90	30	29-1/2	7	4,872	4,872	-	-	-
TFE-3096-PE [ ]	96	30	29-1/2	7	5,009	5,009	-	-	-
TFE-3660-PE [ ]	60	36	29-1/2	5	3,713	3,713	-	-	-
TFE-3666-PE [ ]	66	36	29-1/2	5	4,059	4,059	-	-	-
TFE-3672-PE [ ]	72	36	29-1/2	5	4,200	4,200	-	-	-
TFE-3678-PE [ ]	78	36	29-1/2	5	4,641	4,641	-	-	-
TFE-3684-PE [ ]	84	36	29-1/2	7	4,792	4,792	-	-	-
TFE-3690-PE [ ]	90	36	29-1/2	7	5,198	5,198	-	-	-
TFE-3696-PE [ ]	96	36	29-1/2	7	5,356	5,356	-	-	-
TFE-4260-PE [ ]	60	42	29-1/2	5	4,236	4,236	-	-	-
TFE-4266-PE [ ]	66	42	29-1/2	5	4,645	4,645	-	-	-
TFE-4272-PE [ ]	72	42	29-1/2	5	4,819	4,819	4,819	5,044	5,297
TFE-4278-PE [ ]	78	42	29-1/2	5	5,339	5,339	5,339	5,580	5,850
TFE-4284-PE [ ]	84	42	29-1/2	7	5,525	5,525	5,525	5,766	6,036
TFE-4290-PE [ ]	90	42	29-1/2	7	6,007	6,007	6,007	6,260	6,545
TFE-4296-PE [ ]	96	42	29-1/2	7	6,202	6,202	6,202	6,455	6,740
TFE-4860-PE [ ]	60	48	29-1/2	5	4,587	4,587	-	-	-
TFE-4866-PE [ ]	66	48	29-1/2	5	5,045	5,045	-	-	-
TFE-4872-PE [ ]	72	48	29-1/2	5	5,246	5,246	5,246	5,478	5,741
TFE-4878-PE [ ]	78	48	29-1/2	7	5,825	5,825	5,825	6,074	6,354
TFE-4884-PE [ ]	84	48	29-1/2	7	6,040	6,040	6,040	6,289	6,569
TFE-4890-PE [ ]	90	48	29-1/2	7	6,581	6,581	6,581	6,842	7,137
TFE-4896-PE [ ]	96	48	29-1/2	7	6,807	6,807	6,807	7,069	7,363

[ ] Slab Base, Specify Paint (-PS) or Veneer (-V)

### OPTIONS

CODE	PRICE	NOTES
Power & Data Options		
		See pages 121-131
Remove Slab Base	Add <b>-WM</b>	Deduct \$699
		Mounted directly to wall
<b>Polished Chrome Finish Options:</b>		
Polished Chrome Open Frame Base	Add <b>-PCOF-TWA</b>	\$1,280
Polished Chrome Post Metal Legs	Add <b>-PCML-TWA</b>	\$590
<b>Monitor Panel Options:</b>		
42"-Wide Monitor Panel	Add <b>-MP30</b>	\$2,076
48"-Wide Monitor Panel	Add <b>-MP36</b>	\$2,288
54"-Wide Monitor Panel	Add <b>-MP42</b>	\$2,502
60"-Wide Monitor Panel	Add <b>-MP48</b>	\$2,717

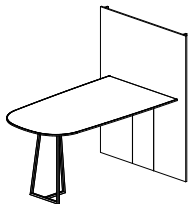

Shown with optional Monitor Panel (-MP)

### EDGE PROFILE



Two4Six Square Edge

### GENERAL INFORMATION

- Tops are 1-1/8"-thick
- Seating capacity based on 27" per person
- Overall table height 29.5"
- Standard with quarter cut veneer
- Must be anchored to a wall, with or without Slab Base
- One section of wire management channel provided per table with Post Metal Leg and Open Frame Bases
- Monitor Panel will be 12" wider than the table specified
- Monitor Panel mounts directly to the wall
- Monitor Panel is 78" high
- Monitor panel available in Paint or Veneer Finish options only
- Only Woodgrain Laminate options are available for the Racetrack Base
- Racetrack Bases have a removable access door

### REQUIRED INFORMATION (ORDER CANNOT BE ENTERED WITHOUT THIS INFORMATION)

See appendix pages vi-vii for surface material options.

- Choose Laminate Finish
- Choose ABS Edge Finish or Coordinating Woodgrain Edgeband finish
- Choose Paint Finish, if -PS Slab Base is specified
- Choose Veneer Finish, if -V Slab Base is specified
- Choose Metal Finish, if -OF or -ML Base is specified (Clear Anodized (-CA) is an option on the Post Metal Leg only)



# GLASS TOP



D-SHAPE TOP

### BASE KEY

OF	Open Frame	RCL	Laminate Racetrack Base
		RCP	Painted Racetrack Base
		RCV	Veneer Racetrack Base

## D-SHAPE TOP // SLAB BASE // SEATED HEIGHT

MODEL #	LENGTH	WIDTH	HEIGHT	SEATING CAPACITY	-OF	-RCL	-RCP	-RCV
TFE-3060-G [ ]	60	30	29-1/2	4	6,131	-	-	-
TFE-3066-G [ ]	66	30	29-1/2	5	6,682	-	-	-
TFE-3072-G [ ]	72	30	29-1/2	5	6,894	-	-	-
TFE-3078-G [ ]	78	30	29-1/2	5	7,596	-	-	-
TFE-3084-G [ ]	84	30	29-1/2	7	7,822	-	-	-
TFE-3090-G [ ]	90	30	29-1/2	7	8,463	-	-	-
TFE-3096-G [ ]	96	30	29-1/2	7	8,701	-	-	-
TFE-3660-G [ ]	60	36	29-1/2	5	6,450	-	-	-
TFE-3666-G [ ]	66	36	29-1/2	5	7,052	-	-	-
TFE-3672-G [ ]	72	36	29-1/2	5	7,297	-	-	-
TFE-3678-G [ ]	78	36	29-1/2	5	8,063	-	-	-
TFE-3684-G [ ]	84	36	29-1/2	7	8,325	-	-	-
TFE-3690-G [ ]	90	36	29-1/2	7	9,030	-	-	-
TFE-3696-G [ ]	96	36	29-1/2	7	9,304	-	-	-
TFE-4260-G [ ]	60	42	29-1/2	5	7,359	-	-	-
TFE-4266-G [ ]	66	42	29-1/2	5	8,069	-	-	-
TFE-4272-G [ ]	72	42	29-1/2	5	8,371	8,371	8,761	9,201
TFE-4278-G [ ]	78	42	29-1/2	5	9,275	9,275	9,693	10,162
TFE-4284-G [ ]	84	42	29-1/2	7	9,598	9,598	10,016	10,485
TFE-4290-G [ ]	90	42	29-1/2	7	10,435	10,435	10,874	11,370
TFE-4296-G [ ]	96	42	29-1/2	7	10,774	10,774	11,214	11,708
TFE-4860-G [ ]	60	48	29-1/2	5	7,967	-	-	-
TFE-4866-G [ ]	66	48	29-1/2	5	8,763	-	-	-
TFE-4872-G [ ]	72	48	29-1/2	5	9,112	9,112	9,516	9,972
TFE-4878-G [ ]	78	48	29-1/2	7	10,119	10,119	10,551	11,037
TFE-4884-G [ ]	84	48	29-1/2	7	10,493	10,493	10,925	11,412
TFE-4890-G [ ]	90	48	29-1/2	7	11,432	11,432	11,886	12,398
TFE-4896-G [ ]	96	48	29-1/2	7	11,825	11,825	12,279	12,791

[ ] Slab Base, Specify Paint (-PS) or Veneer (-V)

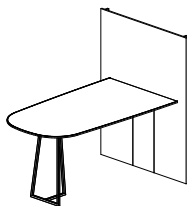

Shown with optional Monitor Panel (-MP)

OPTIONS	CODE	PRICE	NOTES
Power & Data Options			See pages 121-131
Remove Slab Base	Add <b>-WM</b>	Deduct \$699	Mounted directly to wall
<b>Polished Chrome Finish Options:</b>			
Polished Chrome Open Frame Base	Add <b>-PCOF-TWA</b>	\$1,280	
<b>Satin Glass Options:</b>			
Satin Glass	Add <b>-TFSG</b>	\$661	
<b>Monitor Panel Options:</b>			
42"-Wide Monitor Panel	Add <b>-MP30</b>	\$2,076	For use with 30"-Wide Tables
48"-Wide Monitor Panel	Add <b>-MP36</b>	\$2,288	For use with 36"-Wide Tables
54"-Wide Monitor Panel	Add <b>-MP42</b>	\$2,502	For use with 42"-Wide Tables
60"-Wide Monitor Panel	Add <b>-MP48</b>	\$2,717	For use with 48"-Wide Tables

### EDGE PROFILE

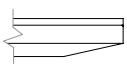

Two4Six Glass Edge

### GENERAL INFORMATION

- Tops are 1-1/8"-thick with 3/16"-thick hardwood edge band
- Seating capacity based on 27" per person
- Overall table height 29.5"
- Standard with quarter cut veneer
- Must be anchored to a wall, with or without Slab Base
- One section of wire management channel provided per table
- Monitor Panel will be 12" wider than the table specified
- Monitor Panel mounts directly to the wall
- Monitor Panel is 78" high
- Monitor panel available in Paint or Veneer Finish options only
- Only Woodgrain Laminate options are available for the Racetrack Base
- Racetrack Bases have a removable access door

### REQUIRED INFORMATION (ORDER CANNOT BE ENTERED WITHOUT THIS INFORMATION)

See appendix pages vi-vii for surface material options.

- Choose Glass Finish
- Choose Veneer Finish, if applicable
- Choose Paint Finish if -PS Base is specified
- Choose Metal Finish
- Choose ABS Finish or Coordinating Woodgrain Edgeband finish if -RCL base specified
- Choose Sub-Top Finish: Paint Finish or Wood Species & Finish





# SOLID SURFACE TOP



D-SHAPE TOP

### BASE KEY

OF	Open Frame	RCL	Laminate Racetrack Base
		RCP	Painted Racetrack Base
		RCV	Veneer Racetrack Base

## D-SHAPE TOP // SLAB BASE // SEATED HEIGHT

MODEL #	LENGTH	WIDTH	HEIGHT	SEATING CAPACITY	-OF	-RCL	-RCP	-RCV
TFE-3060-SS [ ]	60	30	29-1/2	4	6,406	-	-	-
TFE-3066-SS [ ]	66	30	29-1/2	5	6,982	-	-	-
TFE-3072-SS [ ]	72	30	29-1/2	5	7,203	-	-	-
TFE-3078-SS [ ]	78	30	29-1/2	5	7,937	-	-	-
TFE-3084-SS [ ]	84	30	29-1/2	7	8,173	-	-	-
TFE-3090-SS [ ]	90	30	29-1/2	7	8,843	-	-	-
TFE-3096-SS [ ]	96	30	29-1/2	7	9,091	-	-	-
TFE-3660-SS [ ]	60	36	29-1/2	5	6,739	-	-	-
TFE-3666-SS [ ]	66	36	29-1/2	5	7,368	-	-	-
TFE-3672-SS [ ]	72	36	29-1/2	5	7,624	-	-	-
TFE-3678-SS [ ]	78	36	29-1/2	5	8,424	-	-	-
TFE-3684-SS [ ]	84	36	29-1/2	7	8,698	-	-	-
TFE-3690-SS [ ]	90	36	29-1/2	7	9,435	-	-	-
TFE-3696-SS [ ]	96	36	29-1/2	7	9,722	-	-	-
TFE-4260-SS [ ]	60	42	29-1/2	5	7,689	-	-	-
TFE-4266-SS [ ]	66	42	29-1/2	5	8,431	-	-	-
TFE-4272-SS [ ]	72	42	29-1/2	5	8,747	8,747	9,155	9,614
TFE-4278-SS [ ]	78	42	29-1/2	5	9,691	9,691	10,128	10,618
TFE-4284-SS [ ]	84	42	29-1/2	7	10,028	10,028	10,465	10,956
TFE-4290-SS [ ]	90	42	29-1/2	7	10,904	10,904	11,362	11,880
TFE-4296-SS [ ]	96	42	29-1/2	7	11,257	11,257	11,717	12,234
TFE-4860-SS [ ]	60	48	29-1/2	5	8,325	-	-	-
TFE-4866-SS [ ]	66	48	29-1/2	5	9,156	-	-	-
TFE-4872-SS [ ]	72	48	29-1/2	5	9,521	9,521	9,943	10,419
TFE-4878-SS [ ]	78	48	29-1/2	7	10,573	10,573	11,024	11,533
TFE-4884-SS [ ]	84	48	29-1/2	7	10,964	10,964	11,415	11,924
TFE-4890-SS [ ]	90	48	29-1/2	7	11,945	11,945	12,419	12,954
TFE-4896-SS [ ]	96	48	29-1/2	7	12,356	12,356	12,830	13,365

[ ] Slab Base, Specify Paint (-PS) or Veneer (-V)

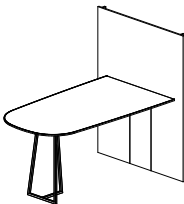

Shown with optional Monitor Panel (-MP)

OPTIONS	CODE	PRICE	NOTES
Power & Data Options			See pages 121-131
Remove Slab Base	Add <b>-WM</b>	Deduct \$699	Mounted directly to wall
<b>Polished Chrome Finish Options:</b>			
Polished Chrome Open Frame Base	Add <b>-PCOF-TWA</b>	\$1,280	
<b>Monitor Panel Options:</b>			
42"-Wide Monitor Panel	Add <b>-MP30</b>	\$2,076	For use with 30"-Wide Tables
48"-Wide Monitor Panel	Add <b>-MP36</b>	\$2,288	For use with 36"-Wide Tables
54"-Wide Monitor Panel	Add <b>-MP42</b>	\$2,502	For use with 42"-Wide Tables
60"-Wide Monitor Panel	Add <b>-MP48</b>	\$2,717	For use with 48"-Wide Tables

### EDGE PROFILE

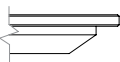

Two4Six Solid Surface Edge

### GENERAL INFORMATION

- Seating capacity based on 27" per person
- Overall table height 29.5"
- Standard with quarter cut veneer
- Must be anchored to a wall, with or without Slab Base
- One section of wire management channel provided per table
- Monitor Panel will be 12" wider than the table specified
- Monitor Panel mounts directly to the wall
- Monitor Panel is 78" high
- Monitor panel available in Paint or Veneer Finish options only
- Only Woodgrain Laminate options are available for the Racetrack Base
- Racetrack Bases have a removable access door

### REQUIRED INFORMATION (ORDER CANNOT BE ENTERED WITHOUT THIS INFORMATION)

See appendix pages vi-vii for surface material options.

- Choose Solid Surface Finish
- Choose Veneer Finish, if applicable
- Choose Paint Finish if -PS Base is specified
- Choose Metal Finish
- Choose ABS Finish or Coordinating Woodgrain Edgeband finish if -RCL base specified



# VENEER TOP WITH HARDWOOD EDGE



D-SHAPE TOP

**BASE KEY**

OF Open Frame

**D-SHAPE TOP // SLAB BASE // COUNTER HEIGHT**

MODEL #	LENGTH	WIDTH	HEIGHT	SEATING CAPACITY	-OF
TFH-3060-V [ ]	60	30	36	5	4,033
TFH-3660-V [ ]	60	36	36	5	4,237
TFH-4260-V [ ]	60	42	36	5	4,829
TFH-4860-V [ ]	60	48	36	5	5,224
TFH-3066-V [ ]	66	30	36	5	4,393
TFH-3666-V [ ]	66	36	36	5	4,630
TFH-4266-V [ ]	66	42	36	5	5,291
TFH-4866-V [ ]	66	48	36	5	5,740
TFH-3072-V [ ]	72	30	36	5	4,528
TFH-3672-V [ ]	72	36	36	5	4,786
TFH-4272-V [ ]	72	42	36	5	5,485
TFH-4872-V [ ]	72	48	36	5	5,964
TFH-3078-V [ ]	78	30	36	5	4,986
TFH-3678-V [ ]	78	36	36	5	5,285
TFH-4278-V [ ]	78	42	36	5	6,072
TFH-4878-V [ ]	78	48	36	5	6,618
TFH-3084-V [ ]	84	30	36	7	5,131
TFH-3684-V [ ]	84	36	36	7	5,453
TFH-4284-V [ ]	84	42	36	7	6,279
TFH-4884-V [ ]	84	48	36	7	6,858
TFH-3090-V [ ]	90	30	36	7	5,548
TFH-3690-V [ ]	90	36	36	7	5,911
TFH-4290-V [ ]	90	42	36	7	6,822
TFH-4890-V [ ]	90	48	36	7	7,466
TFH-3096-V [ ]	96	30	36	7	5,700
TFH-3696-V [ ]	96	36	36	7	6,087
TFH-4296-V [ ]	96	42	36	7	7,040
TFH-4896-V [ ]	96	48	36	7	7,718

[ ] Slab Base, Specify Paint (-PS) or Veneer (-V)

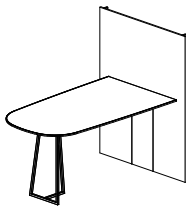

Shown with optional Monitor Panel (-MP)

**OPTIONS**

	CODE	PRICE	NOTES
Power & Data Options			See pages 121-131
Remove Slab Base	Add <b>-WM</b>	Deduct \$699	Mounted directly to wall
<b>Polished Chrome Finish Options:</b>			
Polished Chrome Open Frame Base	Add <b>-PCOF-TWC</b>	\$1,464	
<b>Monitor Panel Options:</b>			
42"-Wide Monitor Panel	Add <b>-MP30</b>	\$2,076	For use with 30"-Wide Tables
48"-Wide Monitor Panel	Add <b>-MP36</b>	\$2,288	For use with 36"-Wide Tables
54"-Wide Monitor Panel	Add <b>-MP42</b>	\$2,502	For use with 42"-Wide Tables
60"-Wide Monitor Panel	Add <b>-MP48</b>	\$2,717	For use with 48"-Wide Tables

**EDGE PROFILE**

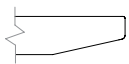

Two4Six Cutback Edge

**GENERAL INFORMATION**

- Tops are 1-1/8"-thick with 3/16"-thick hardwood edge band
- Seating capacity based on 27" per person
- Overall table height 36"
- Standard with quarter cut veneer
- Must be anchored to a wall, with or without Slab Base
- One section of wire management channel provided per table
- Monitor Panel will be 12" wider than the table specified
- Monitor Panel mounts directly to the wall
- Monitor Panel is 78" high

**REQUIRED INFORMATION (ORDER CANNOT BE ENTERED WITHOUT THIS INFORMATION)**

- See appendix pages vi-vii for surface material options.
- Choose Veneer Finish. If -V option is specified for the Slab Base, the finish will be the same as the table top.
  - Choose Paint Finish, if -PS Slab Base is specified
  - Choose Metal Finish



# INSET LAMINATE TOP WITH HARDWOOD EDGE



D-SHAPE TOP

**BASE KEY**

OF Open Frame

**D-SHAPE TOP // SLAB BASE // COUNTER HEIGHT**

MODEL #	LENGTH	WIDTH	HEIGHT	SEATING CAPACITY	-OF
TFH-3060-P [ ]	60	30	36	5	3,812
TFH-3660-P [ ]	60	36	36	5	4,004
TFH-4260-P [ ]	60	42	36	5	4,564
TFH-4860-P [ ]	60	48	36	5	4,937
TFH-3066-P [ ]	66	30	36	5	4,152
TFH-3666-P [ ]	66	36	36	5	4,376
TFH-4266-P [ ]	66	42	36	5	5,000
TFH-4866-P [ ]	66	48	36	5	5,425
TFH-3072-P [ ]	72	30	36	5	4,279
TFH-3672-P [ ]	72	36	36	5	4,523
TFH-4272-P [ ]	72	42	36	5	5,184
TFH-4872-P [ ]	72	48	36	5	5,636
TFH-3078-P [ ]	78	30	36	5	4,712
TFH-3678-P [ ]	78	36	36	5	4,995
TFH-4278-P [ ]	78	42	36	5	5,739
TFH-4878-P [ ]	78	48	36	5	6,255
TFH-3084-P [ ]	84	30	36	7	4,849
TFH-3684-P [ ]	84	36	36	7	5,154
TFH-4284-P [ ]	84	42	36	7	5,934
TFH-4884-P [ ]	84	48	36	7	6,481
TFH-3090-P [ ]	90	30	36	7	5,243
TFH-3690-P [ ]	90	36	36	7	5,586
TFH-4290-P [ ]	90	42	36	7	6,447
TFH-4890-P [ ]	90	48	36	7	7,056
TFH-3096-P [ ]	96	30	36	7	5,387
TFH-3696-P [ ]	96	36	36	7	5,753
TFH-4296-P [ ]	96	42	36	7	6,653
TFH-4896-P [ ]	96	48	36	7	7,294

[ ] Slab Base, Specify Paint (-PS) or Veneer (-V)

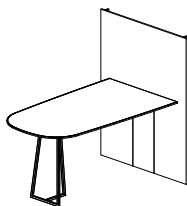

Shown with optional Monitor Panel (-MP)

**OPTIONS**

Power & Data Options

Remove Slab Base

**Polished Chrome Finish Options:**

Polished Chrome Open Frame Base

**Monitor Panel Options:**

42"-Wide Monitor Panel

48"-Wide Monitor Panel

54"-Wide Monitor Panel

60"-Wide Monitor Panel

**CODE**

Add **-WM**

Add **-PCOF-TWC**

Add **-MP30**

Add **-MP36**

Add **-MP42**

Add **-MP48**

**PRICE**

Deduct \$699

\$1,464

\$2,076

\$2,288

\$2,502

\$2,717

**NOTES**

See pages 121-131

Mounted directly to wall

For use with 30"-Wide Tables

For use with 36"-Wide Tables

For use with 42"-Wide Tables

For use with 48"-Wide Tables

**EDGE PROFILE**

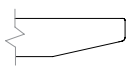

Two4Six Cutback Edge

**GENERAL INFORMATION**

- Tops are 1-1/8"-thick with 3/16"-thick hardwood edge band
- Seating capacity based on 27" per person
- Overall table height 36"
- Standard with quarter cut veneer
- Must be anchored to a wall, with or without Slab Base
- One section of wire management channel provided per table

- Monitor Panel will be 12" wider than the table specified
- Monitor Panel mounts directly to the wall
- Monitor Panel is 78" high
- Monitor panel available in Paint or Veneer Finish options only

**REQUIRED INFORMATION (ORDER CANNOT BE ENTERED WITHOUT THIS INFORMATION)**

See appendix pages vi-vii for surface material options.

- Choose Laminate Finish
- Choose Wood Species & Finish for Hardwood Edge
- Choose Metal Finish
- Choose Paint Finish, if -PS Slab Base is specified
- Choose Veneer Finish, if -V Slab Base is specified



## LAMINATE TOP WITH ABS CUTBACK EDGE



D-SHAPE TOP

## BASE KEY

OF Open Frame

## D-SHAPE TOP // SLAB BASE // COUNTER HEIGHT

MODEL #	LENGTH	WIDTH	HEIGHT	SEATING CAPACITY	-OF
TFH-3060-PA [ ]	60	30	36	5	3,812
TFH-3660-PA [ ]	60	36	36	5	4,004
TFH-4260-PA [ ]	60	42	36	5	4,564
TFH-4860-PA [ ]	60	48	36	5	4,937
TFH-3066-PA [ ]	66	30	36	5	4,152
TFH-3666-PA [ ]	66	36	36	5	4,376
TFH-4266-PA [ ]	66	42	36	5	5,000
TFH-4866-PA [ ]	66	48	36	5	5,425
TFH-3072-PA [ ]	72	30	36	5	4,279
TFH-3672-PA [ ]	72	36	36	5	4,523
TFH-4272-PA [ ]	72	42	36	5	5,184
TFH-4872-PA [ ]	72	48	36	5	5,636
TFH-3078-PA [ ]	78	30	36	5	4,712
TFH-3678-PA [ ]	78	36	36	5	4,995
TFH-4278-PA [ ]	78	42	36	5	5,739
TFH-4878-PA [ ]	78	48	36	5	6,255
TFH-3084-PA [ ]	84	30	36	7	4,849
TFH-3684-PA [ ]	84	36	36	7	5,154
TFH-4284-PA [ ]	84	42	36	7	5,934
TFH-4884-PA [ ]	84	48	36	7	6,481
TFH-3090-PA [ ]	90	30	36	7	5,243
TFH-3690-PA [ ]	90	36	36	7	5,586
TFH-4290-PA [ ]	90	42	36	7	6,447
TFH-4890-PA [ ]	90	48	36	7	7,056
TFH-3096-PA [ ]	96	30	36	7	5,387
TFH-3696-PA [ ]	96	36	36	7	5,753
TFH-4296-PA [ ]	96	42	36	7	6,653
TFH-4896-PA [ ]	96	48	36	7	7,294

[ ] Slab Base, Specify Paint (-PS) or Veneer (-V)

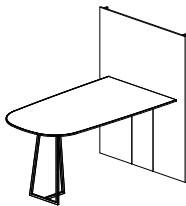

Shown with optional Monitor Panel (-MP)

## OPTIONS

Power &amp; Data Options

## CODE

## PRICE

## NOTES

Remove Slab Base

Add **-WM**

Deduct \$699

Mounted directly to wall

## Polished Chrome Finish Options:

Polished Chrome Open Frame Base

Add **-PCOF-TWC**

\$1,464

## Monitor Panel Options:

42"-Wide Monitor Panel

Add **-MP30**

\$2,076

For use with 30"-Wide Tables

48"-Wide Monitor Panel

Add **-MP36**

\$2,288

For use with 36"-Wide Tables

54"-Wide Monitor Panel

Add **-MP42**

\$2,502

For use with 42"-Wide Tables

60"-Wide Monitor Panel

Add **-MP48**

\$2,717

For use with 48"-Wide Tables

## EDGE PROFILE

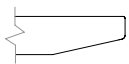

Two4Six Cutback Edge

## GENERAL INFORMATION

- Tops are 1-1/8"-thick
- Seating capacity based on 27" per person
- Overall table height 36"
- Standard with quarter cut veneer
- Must be anchored to a wall, with or without Slab Base
- One section of wire management channel provided per table

- Monitor Panel will be 12" wider than the table specified
- Monitor Panel mounts directly to the wall
- Monitor Panel is 78" high
- Monitor panel available in Paint or Veneer Finish options only

## REQUIRED INFORMATION (ORDER CANNOT BE ENTERED WITHOUT THIS INFORMATION)

See appendix pages vi-vii for surface material options.

- Choose Laminate Finish
- Choose ABS Edge Finish or Coordinating Woodgrain Edgeband finish
- Choose Metal Finish
- Choose Paint Finish, if -PS Slab Base is specified
- Choose Veneer Finish, if -V Slab Base is specified



## LAMINATE TOP WITH ABS SQUARE EDGE



D-SHAPE TOP

## BASE KEY

OF Open Frame

## D-SHAPE TOP // SLAB BASE // COUNTER HEIGHT

MODEL #	LENGTH	WIDTH	HEIGHT	SEATING CAPACITY	-OF
TFH-3060-PE [ ]	60	30	36	5	3,622
TFH-3660-PE [ ]	60	36	36	5	3,805
TFH-4260-PE [ ]	60	42	36	5	4,337
TFH-4860-PE [ ]	60	48	36	5	4,692
TFH-3066-PE [ ]	66	30	36	5	3,945
TFH-3666-PE [ ]	66	36	36	5	4,158
TFH-4266-PE [ ]	66	42	36	5	4,752
TFH-4866-PE [ ]	66	48	36	5	5,155
TFH-3072-PE [ ]	72	30	36	5	4,067
TFH-3672-PE [ ]	72	36	36	5	4,298
TFH-4272-PE [ ]	72	42	36	5	4,926
TFH-4872-PE [ ]	72	48	36	5	5,356
TFH-3078-PE [ ]	78	30	36	5	4,478
TFH-3678-PE [ ]	78	36	36	5	4,746
TFH-4278-PE [ ]	78	42	36	5	5,453
TFH-4878-PE [ ]	78	48	36	5	5,943
TFH-3084-PE [ ]	84	30	36	7	4,608
TFH-3684-PE [ ]	84	36	36	7	4,897
TFH-4284-PE [ ]	84	42	36	7	5,639
TFH-4884-PE [ ]	84	48	36	7	6,159
TFH-3090-PE [ ]	90	30	36	7	4,983
TFH-3690-PE [ ]	90	36	36	7	5,309
TFH-4290-PE [ ]	90	42	36	7	6,127
TFH-4890-PE [ ]	90	48	36	7	6,705
TFH-3096-PE [ ]	96	30	36	7	5,119
TFH-3696-PE [ ]	96	36	36	7	5,467
TFH-4296-PE [ ]	96	42	36	7	6,322
TFH-4896-PE [ ]	96	48	36	7	6,931

[ ] Slab Base, Specify Paint (-PS) or Veneer (-V)

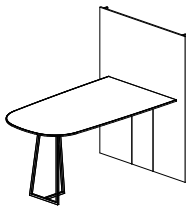

Shown with optional Monitor Panel (-MP)

## OPTIONS

Power &amp; Data Options

## CODE

## PRICE

## NOTES

See pages 121-131

Remove Slab Base

Add **-WM**

Deduct \$699

Mounted directly to wall

## Polished Chrome Finish Options:

Polished Chrome Open Frame Base

Add **-PCOF-TWC**

\$1,464

## Monitor Panel Options:

42"-Wide Monitor Panel

Add **-MP30**

\$2,076

For use with 30"-Wide Tables

48"-Wide Monitor Panel

Add **-MP36**

\$2,288

For use with 36"-Wide Tables

54"-Wide Monitor Panel

Add **-MP42**

\$2,502

For use with 42"-Wide Tables

60"-Wide Monitor Panel

Add **-MP48**

\$2,717

For use with 48"-Wide Tables

## EDGE PROFILE



Two4Six Square Edge

## GENERAL INFORMATION

- Tops are 1-1/8"-thick
- Seating capacity based on 27" per person
- Overall table height 36"
- Standard with quarter cut veneer
- Must be anchored to a wall, with or without Slab Base
- One section of wire management channel provided per table
- Monitor Panel will be 12" wider than the table specified
- Monitor Panel mounts directly to the wall
- Monitor Panel is 78" high
- Monitor panel available in Paint or Veneer Finish options only

## REQUIRED INFORMATION (ORDER CANNOT BE ENTERED WITHOUT THIS INFORMATION)

See appendix pages vi-vii for surface material options.

- Choose Laminate Finish
- Choose ABS Edge Finish or Coordinating Woodgrain Edgeband finish
- Choose Metal Finish
- Choose Paint Finish, if -PS Slab Base is specified
- Choose Veneer Finish, if -V Slab Base is specified



## GLASS TOP



D-SHAPE TOP

## BASE KEY

OF Open Frame

## D-SHAPE TOP // SLAB BASE // COUNTER HEIGHT

MODEL #	LENGTH	WIDTH	HEIGHT	SEATING CAPACITY	-OF
TFH-3060-G [ ]	60	30	36	5	6,292
TFH-3660-G [ ]	60	36	36	5	6,610
TFH-4260-G [ ]	60	42	36	5	7,534
TFH-4860-G [ ]	60	48	36	5	8,150
TFH-3066-G [ ]	66	30	36	5	6,854
TFH-3666-G [ ]	66	36	36	5	7,223
TFH-4266-G [ ]	66	42	36	5	8,254
TFH-4866-G [ ]	66	48	36	5	8,955
TFH-3072-G [ ]	72	30	36	5	7,064
TFH-3672-G [ ]	72	36	36	5	7,467
TFH-4272-G [ ]	72	42	36	5	8,557
TFH-4872-G [ ]	72	48	36	5	9,304
TFH-3078-G [ ]	78	30	36	5	7,779
TFH-3678-G [ ]	78	36	36	5	8,245
TFH-4278-G [ ]	78	42	36	5	9,473
TFH-4878-G [ ]	78	48	36	5	10,325
TFH-3084-G [ ]	84	30	36	7	8,005
TFH-3684-G [ ]	84	36	36	7	8,507
TFH-4284-G [ ]	84	42	36	7	9,796
TFH-4884-G [ ]	84	48	36	7	10,699
TFH-3090-G [ ]	90	30	36	7	8,655
TFH-3690-G [ ]	90	36	36	7	9,222
TFH-4290-G [ ]	90	42	36	7	10,643
TFH-4890-G [ ]	90	48	36	7	11,647
TFH-3096-G [ ]	96	30	36	7	8,892
TFH-3696-G [ ]	96	36	36	7	9,496
TFH-4296-G [ ]	96	42	36	7	10,983
TFH-4896-G [ ]	96	48	36	7	12,041

[ ] Slab Base, Specify Paint (-PS) or Veneer (-V)

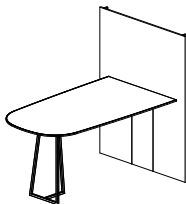

Shown with optional Monitor Panel (-MP)

## OPTIONS

Power &amp; Data Options

## CODE

## PRICE

## NOTES

See pages 121-131

Remove Slab Base

Add **-WM**

Deduct \$699

Mounted directly to wall

## Polished Chrome Finish Options:

Polished Chrome Open Frame Base

Add **-PCOF-TWC**

\$1,464

## Satin Glass Options:

Satin Glass

Add **-TFSG**

\$661

## Monitor Panel Options:

42"-Wide Monitor Panel

Add **-MP30**

\$2,076

For use with 30"-Wide Tables

48"-Wide Monitor Panel

Add **-MP36**

\$2,288

For use with 36"-Wide Tables

54"-Wide Monitor Panel

Add **-MP42**

\$2,502

For use with 42"-Wide Tables

60"-Wide Monitor Panel

Add **-MP48**

\$2,717

For use with 48"-Wide Tables

## EDGE PROFILE



Two4Six Glass Edge

## GENERAL INFORMATION

- Tops are 1-1/8"-thick with 3/16"-thick hardwood edge band
- Seating capacity based on 27" per person
- Overall table height 36"
- Standard with quarter cut veneer
- Must be anchored to a wall, with or without Slab Base
- One section of wire management channel provided per table

- Monitor Panel will be 12" wider than the table specified
- Monitor Panel mounts directly to the wall
- Monitor Panel is 78" high
- Monitor panel available in Paint or Veneer Finish options only

## REQUIRED INFORMATION (ORDER CANNOT BE ENTERED WITHOUT THIS INFORMATION)

See appendix pages vi-vii for surface material options.

- Choose Glass Finish
- Choose Metal Finish
- Choose Paint Finish, if -PS Slab Base is specified
- Choose Veneer Finish, if -V Slab Base is specified
- Choose Sub-Top Finish: Paint Finish or Wood Species & Finish



# SOLID SURFACE TOP



D-SHAPE TOP

**BASE KEY**

OF Open Frame

**D-SHAPE TOP // SLAB BASE // COUNTER HEIGHT**

MODEL #	LENGTH	WIDTH	HEIGHT	SEATING CAPACITY	-OF
TFH-3060-SS [ ]	60	30	36	5	6,574
TFH-3660-SS [ ]	60	36	36	5	6,907
TFH-4260-SS [ ]	60	42	36	5	7,872
TFH-4860-SS [ ]	60	48	36	5	8,516
TFH-3066-SS [ ]	66	30	36	5	7,161
TFH-3666-SS [ ]	66	36	36	5	7,547
TFH-4266-SS [ ]	66	42	36	5	8,625
TFH-4866-SS [ ]	66	48	36	5	9,357
TFH-3072-SS [ ]	72	30	36	5	7,381
TFH-3672-SS [ ]	72	36	36	5	7,802
TFH-4272-SS [ ]	72	42	36	5	8,941
TFH-4872-SS [ ]	72	48	36	5	9,722
TFH-3078-SS [ ]	78	30	36	5	8,128
TFH-3678-SS [ ]	78	36	36	5	8,615
TFH-4278-SS [ ]	78	42	36	5	9,898
TFH-4878-SS [ ]	78	48	36	5	10,788
TFH-3084-SS [ ]	84	30	36	7	8,364
TFH-3684-SS [ ]	84	36	36	7	8,889
TFH-4284-SS [ ]	84	42	36	7	10,235
TFH-4884-SS [ ]	84	48	36	7	11,179
TFH-3090-SS [ ]	90	30	36	7	9,044
TFH-3690-SS [ ]	90	36	36	7	9,635
TFH-4290-SS [ ]	90	42	36	7	11,120
TFH-4890-SS [ ]	90	48	36	7	12,170
TFH-3096-SS [ ]	96	30	36	7	9,291
TFH-3696-SS [ ]	96	36	36	7	9,922
TFH-4296-SS [ ]	96	42	36	7	11,476
TFH-4896-SS [ ]	96	48	36	7	12,581

[ ] Slab Base, Specify Paint (-PS) or Veneer (-V)

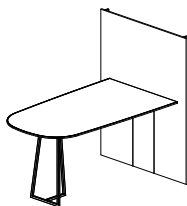

Shown with optional Monitor Panel (-MP)

OPTIONS	CODE	PRICE	NOTES
Power & Data Options			See pages 121-131
Remove Slab Base	Add <b>-WM</b>	Deduct \$699	Mounted directly to wall
<b>Polished Chrome Finish Options:</b>			
Polished Chrome Open Frame Base	Add <b>-PCOF-TWC</b>	\$1,464	
<b>Monitor Panel Options:</b>			
42"-Wide Monitor Panel	Add <b>-MP30</b>	\$2,076	For use with 30"-Wide Tables
48"-Wide Monitor Panel	Add <b>-MP36</b>	\$2,288	For use with 36"-Wide Tables
54"-Wide Monitor Panel	Add <b>-MP42</b>	\$2,502	For use with 42"-Wide Tables
60"-Wide Monitor Panel	Add <b>-MP48</b>	\$2,717	For use with 48"-Wide Tables

**EDGE PROFILE**



Two4Six Solid Surface Edge

**GENERAL INFORMATION**

- Seating capacity based on 27" per person
- Overall table height 36"
- Standard with quarter cut veneer
- Must be anchored to a wall, with or without Slab Base
- One section of wire management channel provided per table
- Monitor Panel will be 12" wider than the table specified
- Monitor Panel mounts directly to the wall
- Monitor Panel is 78" high
- Monitor panel available in Paint or Veneer Finish options only

**REQUIRED INFORMATION (ORDER CANNOT BE ENTERED WITHOUT THIS INFORMATION)**

See appendix pages vi-vii for surface material options.

- Choose Solid Surface Finish
- Choose Metal Finish
- Choose Paint Finish, if -PS Slab Base is specified
- Choose Veneer Finish, if -V Slab Base is specified



# VENEER TOP WITH HARDWOOD EDGE



D-SHAPE TOP

**BASE KEY**

OF	Open Frame	RCL	Laminate Racetrack Base
		RCP	Painted Racetrack Base
		RCV	Veneer Racetrack Base

**D-SHAPE TOP // SLAB BASE // STANDING HEIGHT**

MODEL #	LENGTH	WIDTH	HEIGHT	SEATING CAPACITY	-OF	-RCL	-RCP	-RCV [ ]
TFN-3060-V [ ]	60	30	42	5	4,137	-	-	-
TFN-3066-V [ ]	66	30	42	5	4,502	-	-	-
TFN-3072-V [ ]	72	30	42	5	4,638	-	-	-
TFN-3078-V [ ]	78	30	42	5	5,103	-	-	-
TFN-3084-V [ ]	84	30	42	7	5,248	-	-	-
TFN-3090-V [ ]	90	30	42	7	5,672	-	-	-
TFN-3096-V [ ]	96	30	42	7	5,823	-	-	-
TFN-3660-V [ ]	60	36	42	5	4,341	-	-	-
TFN-3666-V [ ]	66	36	42	5	4,739	-	-	-
TFN-3672-V [ ]	72	36	42	5	4,896	-	-	-
TFN-3678-V [ ]	78	36	42	5	5,402	-	-	-
TFN-3684-V [ ]	84	36	42	7	5,570	-	-	-
TFN-3690-V [ ]	90	36	42	7	6,035	-	-	-
TFN-3696-V [ ]	96	36	42	7	6,210	-	-	-
TFN-4260-V [ ]	60	42	42	5	4,942	-	-	-
TFN-4266-V [ ]	66	42	42	5	5,410	-	-	-
TFN-4272-V [ ]	72	42	42	5	5,604	5,604	6,027	6,390
TFN-4278-V [ ]	78	42	42	5	6,199	6,199	6,651	7,040
TFN-4284-V [ ]	84	42	42	7	6,406	6,406	6,858	7,247
TFN-4290-V [ ]	90	42	42	7	6,956	6,956	7,432	7,841
TFN-4296-V [ ]	96	42	42	7	7,174	7,174	7,650	8,058
TFN-4860-V [ ]	60	48	42	5	5,341	-	-	-
TFN-4866-V [ ]	66	48	42	5	5,863	-	-	-
TFN-4872-V [ ]	72	48	42	5	6,087	6,087	6,524	6,900
TFN-4878-V [ ]	78	48	42	5	6,750	6,750	7,217	7,619
TFN-4884-V [ ]	84	48	42	7	6,990	6,990	7,457	7,859
TFN-4890-V [ ]	90	48	42	7	7,605	7,605	8,097	8,520
TFN-4896-V [ ]	96	48	42	7	7,857	7,857	8,349	8,771

[ ] Slab Base, Specify Paint (-PS) or Veneer (-V)

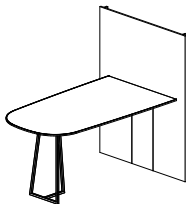

Shown with optional Monitor Panel (-MP)

**OPTIONS**

OPTIONS	CODE	PRICE	NOTES
Power & Data Options			See pages 121-131
Remove Slab Base	Add <b>-WM</b>	Deduct \$699	Mounted directly to wall
<b>Polished Chrome Finish Options:</b>			
Polished Chrome Open Frame Base	Add <b>-PCOF-TWD</b>	\$1,654	
<b>Monitor Panel Options:</b>			
42"-Wide Monitor Panel	Add <b>-MP30</b>	\$2,076	For use with 30"-Wide Tables
48"-Wide Monitor Panel	Add <b>-MP36</b>	\$2,288	For use with 36"-Wide Tables
54"-Wide Monitor Panel	Add <b>-MP42</b>	\$2,502	For use with 42"-Wide Tables
60"-Wide Monitor Panel	Add <b>-MP48</b>	\$2,717	For use with 48"-Wide Tables

**EDGE PROFILE**



Two4Six Cutback Edge

**GENERAL INFORMATION**

- Tops are 1-1/8"-thick with 3/16"-thick hardwood edge band
- Seating capacity based on 27" per person
- Overall table height 42"
- Standard with quarter cut veneer
- Must be anchored to a wall, with or without Slab Base
- One section of wire management channel provided per table
- Monitor Panel will be 12" wider than the table specified
- Monitor Panel mounts directly to the wall
- Monitor Panel is 78" high
- Not available with Power Matrix
- Only Woodgrain Laminate options are available for the Racetrack Base
- Racetrack Bases have a removable access door

**REQUIRED INFORMATION (ORDER CANNOT BE ENTERED WITHOUT THIS INFORMATION)**

- See appendix pages vi-vii for surface material options.
- Choose Veneer Finish. If -V option is specified for the Slab Base, the finish will be the same as the table top.
  - Choose Paint Finish, if -PS Slab Base is specified
  - Choose Metal Finish
  - Choose ABS Finish or Coordinating Woodgrain Edgeband finish if -RCL base specified





# INSET LAMINATE TOP WITH HARDWOOD EDGE



D-SHAPE TOP

**BASE KEY**

OF Open Frame

RCL Laminate Racetrack Base  
RCP Painted Racetrack Base  
RCV Veneer Racetrack Base

**D-SHAP [ ] E TOP [ ] // SLAB BASE // STANDING HEIGHT**

MODEL #	LENGTH	WIDTH	HEIGHT	SEATING CAP [ ] ACITY	-OF	-RCL	-RCP [ ]	-RCV
TFN-3060-P [ ]	60	30	42	5	3,910	-	-	-
TFN-3066-P [ ]	66	30	42	5	4,255	-	-	-
TFN-3072-P [ ]	72	30	42	5	4,383	-	-	-
TFN-3078-P [ ]	78	30	42	5	4,823	-	-	-
TFN-3084-P [ ]	84	30	42	7	4,960	-	-	-
TFN-3090-P [ ]	90	30	42	7	5,361	-	-	-
TFN-3096-P [ ]	96	30	42	7	5,503	-	-	-
TFN-3660-P [ ]	60	36	42	5	4,103	-	-	-
TFN-3666-P [ ]	66	36	42	5	4,479	-	-	-
TFN-3672-P [ ]	72	36	42	5	4,627	-	-	-
TFN-3678-P [ ]	78	36	42	5	5,105	-	-	-
TFN-3684-P [ ]	84	36	42	7	5,264	-	-	-
TFN-3690-P [ ]	90	36	42	7	5,704	-	-	-
TFN-3696-P [ ]	96	36	42	7	5,869	-	-	-
TFN-4260-P [ ]	60	42	42	5	4,671	-	-	-
TFN-4266-P [ ]	66	42	42	5	5,113	-	-	-
TFN-4272-P [ ]	72	42	42	5	5,296	5,296	5,696	6,039
TFN-4278-P [ ]	78	42	42	5	5,859	5,859	6,286	6,653
TFN-4284-P [ ]	84	42	42	7	6,054	6,054	6,481	6,849
TFN-4290-P [ ]	90	42	42	7	6,574	6,574	7,024	7,410
TFN-4296-P [ ]	96	42	42	7	6,780	6,780	7,230	7,615
TFN-4860-P [ ]	60	48	42	5	5,048	-	-	-
TFN-4866-P [ ]	66	48	42	5	5,541	-	-	-
TFN-4872-P [ ]	72	48	42	5	5,753	5,753	6,166	6,521
TFN-4878-P [ ]	78	48	42	5	6,379	6,379	6,821	7,200
TFN-4884-P [ ]	84	48	42	7	6,606	6,606	7,047	7,427
TFN-4890-P [ ]	90	48	42	7	7,187	7,187	7,652	8,052
TFN-4896-P [ ]	96	48	42	7	7,425	7,425	7,890	8,289

[ ] Slab Base, Specify Paint (-PS) or Veneer (-V)

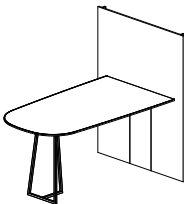

Shown with optional Monitor Panel (-MP)

**OPTIONS**

Power & Data Options

See pages 121-131

Remove Slab Base

Add **-WM**

Deduct \$699

Mounted directly to wall

**Polished Chrome Finish Options:**

Polished Chrome Open Frame Base

Add **-PCOF-TWD**

\$1,654

**Monitor Panel Options:**

42"-Wide Monitor Panel

Add **-MP30**

\$2,076

For use with 30"-Wide Tables

48"-Wide Monitor Panel

Add **-MP36**

\$2,288

For use with 36"-Wide Tables

54"-Wide Monitor Panel

Add **-MP42**

\$2,502

For use with 42"-Wide Tables

60"-Wide Monitor Panel

Add **-MP48**

\$2,717

For use with 48"-Wide Tables

**EDGE PROFILE**

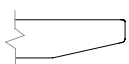

Two4Six Cutback Edge

**GENERAL INFORMATION**

- Tops are 1-1/8"-thick with 3/16"-thick hardwood edge band
- Seating capacity based on 27" per person
- Overall table height 42"
- Standard with quarter cut veneer
- Must be anchored to a wall, with or without Slab Base
- One section of wire management channel provided per table
- Monitor Panel will be 12" wider than the table specified

- Monitor Panel mounts directly to the wall
- Monitor Panel is 78" high
- Monitor panel available in Paint or Veneer Finish options only
- Not available with Power Matrix
- Only Woodgrain Laminate options are available for the Racetrack Base
- Racetrack Bases have a removable access door

**REQUIRED INFORMATION (ORDER CANNOT BE ENTERED WITHOUT THIS INFORMATION)**

See appendix pages vi-vii for surface material options.

- Choose Laminate Finish
- Choose Wood Species & Finish for Hardwood Edge
- Choose Metal Finish
- Choose Paint Finish, if -PS Slab Base is specified
- Choose Veneer Finish, if -V Slab Base is specified
- Choose ABS Finish or Coordinating Woodgrain Edgeband finish if -RCL base specified



# LAMINATE TOP WITH ABS CUTBACK EDGE



D-SHAPE TOP

### BASE KEY

OF Open Frame

RCL Laminate Racetrack Base  
RCP Painted Racetrack Base  
RCV Veneer Racetrack Base

## D-SHAPE TOP // SLAB BASE // STANDING HEIGHT

MODEL #	LENGTH	WIDTH	HEIGHT	SEATING CAPACITY	-OF	-RCL	-RCP	-RCV
TFN-3060-PA [ ]	60	30	42	5	3,910	-	-	-
TFN-3066-PA [ ]	66	30	42	5	4,255	-	-	-
TFN-3072-PA [ ]	72	30	42	5	4,383	-	-	-
TFN-3078-PA [ ]	78	30	42	5	4,823	-	-	-
TFN-3084-PA [ ]	84	30	42	7	4,960	-	-	-
TFN-3090-PA [ ]	90	30	42	7	5,361	-	-	-
TFN-3096-PA [ ]	96	30	42	7	5,503	-	-	-
TFN-3660-PA [ ]	60	36	42	5	4,103	-	-	-
TFN-3666-PA [ ]	66	36	42	5	4,479	-	-	-
TFN-3672-PA [ ]	72	36	42	5	4,627	-	-	-
TFN-3678-PA [ ]	78	36	42	5	5,105	-	-	-
TFN-3684-PA [ ]	84	36	42	7	5,264	-	-	-
TFN-3690-PA [ ]	90	36	42	7	5,704	-	-	-
TFN-3696-PA [ ]	96	36	42	7	5,869	-	-	-
TFN-4260-PA [ ]	60	42	42	5	4,671	-	-	-
TFN-4266-PA [ ]	66	42	42	5	5,113	-	-	-
TFN-4272-PA [ ]	72	42	42	5	5,296	5,296	5,696	6,039
TFN-4278-PA [ ]	78	42	42	5	5,859	5,859	6,286	6,653
TFN-4284-PA [ ]	84	42	42	7	6,054	6,054	6,481	6,849
TFN-4290-PA [ ]	90	42	42	7	6,574	6,574	7,024	7,410
TFN-4296-PA [ ]	96	42	42	7	6,780	6,780	7,230	7,615
TFN-4860-PA [ ]	60	48	42	5	5,048	-	-	-
TFN-4866-PA [ ]	66	48	42	5	5,541	-	-	-
TFN-4872-PA [ ]	72	48	42	5	5,753	5,753	6,166	6,521
TFN-4878-PA [ ]	78	48	42	5	6,379	6,379	6,821	7,200
TFN-4884-PA [ ]	84	48	42	7	6,606	6,606	7,047	7,427
TFN-4890-PA [ ]	90	48	42	7	7,187	7,187	7,652	8,052
TFN-4896-PA [ ]	96	48	42	7	7,425	7,425	7,890	8,289

[ ] Slab Base, Specify Paint (-PS) or Veneer (-V)

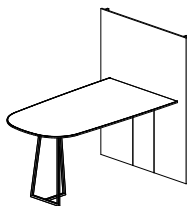

Shown with optional Monitor Panel (-MP)

### OPTIONS

Power & Data Options

See pages 121-131

Remove Slab Base

Add **-WM**

Deduct \$699

Mounted directly to wall

### Polished Chrome Finish Options:

Polished Chrome Open Frame Base

Add **-PCOF-TWD**

\$1,654

### Monitor Panel Options:

42"-Wide Monitor Panel

Add **-MP30**

\$2,076

For use with 30"-Wide Tables

48"-Wide Monitor Panel

Add **-MP36**

\$2,288

For use with 36"-Wide Tables

54"-Wide Monitor Panel

Add **-MP42**

\$2,502

For use with 42"-Wide Tables

60"-Wide Monitor Panel

Add **-MP48**

\$2,717

For use with 48"-Wide Tables

### EDGE PROFILE

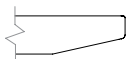

Two4Six Cutback Edge

### GENERAL INFORMATION

- Tops are 1-1/8"-thick
- Seating capacity based on 27" per person
- Overall table height 42"
- Standard with quarter cut veneer
- Must be anchored to a wall, with or without Slab Base
- One section of wire management channel provided per table
- Monitor Panel will be 12" wider than the table specified
- Monitor Panel mounts directly to the wall
- Monitor Panel is 78" high
- Monitor panel available in Paint or Veneer Finish options only
- Not available with Power Matrix
- Only Woodgrain Laminate options are available for the Racetrack Base
- Racetrack Bases have a removable access door

### REQUIRED INFORMATION (ORDER CANNOT BE ENTERED WITHOUT THIS INFORMATION)

See appendix pages vi-vii for surface material options.

- Choose Laminate Finish
- Choose ABS Edge Finish or Coordinating Woodgrain Edgeband finish
- Choose Metal Finish
- Choose Paint Finish, if -PS Slab Base is specified
- Choose Veneer Finish, if -V Slab Base is specified



# LAMINATE TOP WITH ABS SQUARE EDGE



D-SHAPE TOP

**BASE KEY**

OF Open Frame

RCL Laminate Racetrack Base  
RCP Painted Racetrack Base  
RCV Veneer Racetrack Base

**D-SHAPE TOP // SLAB BASE // STANDING HEIGHT**

MODEL #	LENGTH	WIDTH	HEIGHT	SEATING CAPACITY	-OF	-RCL	-RCP	-RCV
TFN-3060-PE [ ]	60	30	42	5	3,716	-	-	-
TFN-3066-PE [ ]	66	30	42	5	4,043	-	-	-
TFN-3072-PE [ ]	72	30	42	5	4,165	-	-	-
TFN-3078-PE [ ]	78	30	42	5	4,583	-	-	-
TFN-3084-PE [ ]	84	30	42	7	4,713	-	-	-
TFN-3090-PE [ ]	90	30	42	7	5,094	-	-	-
TFN-3096-PE [ ]	96	30	42	7	5,230	-	-	-
TFN-3660-PE [ ]	60	36	42	5	3,899	-	-	-
TFN-3666-PE [ ]	66	36	42	5	4,256	-	-	-
TFN-3672-PE [ ]	72	36	42	5	4,397	-	-	-
TFN-3678-PE [ ]	78	36	42	5	4,851	-	-	-
TFN-3684-PE [ ]	84	36	42	7	5,002	-	-	-
TFN-3690-PE [ ]	90	36	42	7	5,420	-	-	-
TFN-3696-PE [ ]	96	36	42	7	5,577	-	-	-
TFN-4260-PE [ ]	60	42	42	5	4,438	-	-	-
TFN-4266-PE [ ]	66	42	42	5	4,859	-	-	-
TFN-4272-PE [ ]	72	42	42	5	5,033	5,033	5,413	5,739
TFN-4278-PE [ ]	78	42	42	5	5,567	5,567	5,973	6,322
TFN-4284-PE [ ]	84	42	42	7	5,753	5,753	6,159	6,508
TFN-4290-PE [ ]	90	42	42	7	6,247	6,247	6,674	7,042
TFN-4296-PE [ ]	96	42	42	7	6,443	6,443	6,870	7,237
TFN-4860-PE [ ]	60	48	42	5	4,797	-	-	-
TFN-4866-PE [ ]	66	48	42	5	5,265	-	-	-
TFN-4872-PE [ ]	72	48	42	5	5,467	5,467	5,859	6,197
TFN-4878-PE [ ]	78	48	42	5	6,062	6,062	6,481	6,842
TFN-4884-PE [ ]	84	48	42	7	6,278	6,278	6,697	7,058
TFN-4890-PE [ ]	90	48	42	7	6,830	6,830	7,272	7,651
TFN-4896-PE [ ]	96	48	42	7	7,056	7,056	7,498	7,877

[ ] Slab Base, Specify Paint (-PS) or Veneer (-V)

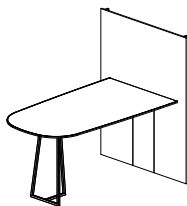

Shown with optional Monitor Panel (-MP)

**OPTIONS**

Power & Data Options

See pages 121-131

Remove Slab Base

Add **-WM**

Deduct \$699

Mounted directly to wall

**Polished Chrome Finish Options:**

Polished Chrome Open Frame Base

Add **-PCOF-TWD**

\$1,654

**Monitor Panel Options:**

42"-Wide Monitor Panel

Add **-MP30**

\$2,076

For use with 30"-Wide Tables

48"-Wide Monitor Panel

Add **-MP36**

\$2,288

For use with 36"-Wide Tables

54"-Wide Monitor Panel

Add **-MP42**

\$2,502

For use with 42"-Wide Tables

60"-Wide Monitor Panel

Add **-MP48**

\$2,717

For use with 48"-Wide Tables

**EDGE PROFILE**



Two4Six Square Edge

**GENERAL INFORMATION**

- Tops are 1-1/8"-thick
- Seating capacity based on 27" per person
- Overall table height 42"
- Standard with quarter cut veneer
- Must be anchored to a wall, with or without Slab Base
- One section of wire management channel provided per table
- Monitor Panel will be 12" wider than the table specified
- Monitor Panel mounts directly to the wall
- Monitor Panel is 78" high
- Monitor panel available in Paint or Veneer Finish options only
- Not available with Power Matrix
- Only Woodgrain Laminate options are available for the Racetrack Base
- Racetrack Bases have a removable access door

**REQUIRED INFORMATION (ORDER CANNOT BE ENTERED WITHOUT THIS INFORMATION)**

See appendix pages vi-vii for surface material options.

- Choose Laminate Finish
- Choose ABS Edge Finish or Coordinating Woodgrain Edgeband finish
- Choose Metal Finish
- Choose Paint Finish, if -PS Slab Base is specified
- Choose Veneer Finish, if -V Slab Base is specified



# GLASS TOP



D-SHAPE TOP

### BASE KEY

OF Open Frame

RCL Laminate Racetrack Base  
RCP Painted Racetrack Base  
RCV Veneer Racetrack Base

## D-SHAPE TOP // SLAB BASE // STANDING HEIGHT

MODEL #	LENGTH	WIDTH	HEIGHT	SEATING CAPACITY	-OF	-RCL	-RCP	-RCV
TFN-3060-G [ ]	60	30	42	5	6,454	-	-	-
TFN-3066-G [ ]	66	30	42	5	7,024	-	-	-
TFN-3072-G [ ]	72	30	42	5	7,236	-	-	-
TFN-3078-G [ ]	78	30	42	5	7,961	-	-	-
TFN-3084-G [ ]	84	30	42	7	8,187	-	-	-
TFN-3090-G [ ]	90	30	42	7	8,849	-	-	-
TFN-3096-G [ ]	96	30	42	7	9,084	-	-	-
TFN-3660-G [ ]	60	36	42	5	6,772	-	-	-
TFN-3666-G [ ]	66	36	42	5	7,393	-	-	-
TFN-3672-G [ ]	72	36	42	5	7,638	-	-	-
TFN-3678-G [ ]	78	36	42	5	8,428	-	-	-
TFN-3684-G [ ]	84	36	42	7	8,690	-	-	-
TFN-3690-G [ ]	90	36	42	7	9,415	-	-	-
TFN-3696-G [ ]	96	36	42	7	9,688	-	-	-
TFN-4260-G [ ]	60	42	42	5	7,710	-	-	-
TFN-4266-G [ ]	66	42	42	5	8,440	-	-	-
TFN-4272-G [ ]	72	42	42	5	8,743	8,743	9,403	9,969
TFN-4278-G [ ]	78	42	42	5	9,671	9,671	10,376	10,983
TFN-4284-G [ ]	84	42	42	7	9,994	9,994	10,699	11,306
TFN-4290-G [ ]	90	42	42	7	10,852	10,852	11,594	12,232
TFN-4296-G [ ]	96	42	42	7	11,192	11,192	11,934	12,571
TFN-4860-G [ ]	60	48	42	5	8,332	-	-	-
TFN-4866-G [ ]	66	48	42	5	9,147	-	-	-
TFN-4872-G [ ]	72	48	42	5	9,496	9,496	10,178	10,764
TFN-4878-G [ ]	78	48	42	5	10,530	10,530	11,259	11,886
TFN-4884-G [ ]	84	48	42	7	10,905	10,905	11,633	12,261
TFN-4890-G [ ]	90	48	42	7	11,864	11,864	12,632	13,292
TFN-4896-G [ ]	96	48	42	7	12,257	12,257	13,025	13,683

[ ] Slab Base, Specify Paint (-PS) or Veneer (-V)

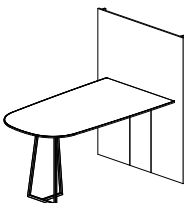

Shown with optional Monitor Panel (-MP)

### OPTIONS

Power & Data Options

See pages 121-131

Remove Slab Base

Add **-WM**

Deduct \$699

Mounted directly to wall

#### Polished Chrome Finish Options:

Polished Chrome Open Frame Base

Add **-PCOF-TWD**

\$1,654

#### Satin Glass Options:

Satin Glass

Add **-TFSG**

\$661

#### Monitor Panel Options:

42"-Wide Monitor Panel

Add **-MP30**

\$2,076

For use with 30"-Wide Tables

48"-Wide Monitor Panel

Add **-MP36**

\$2,288

For use with 36"-Wide Tables

54"-Wide Monitor Panel

Add **-MP42**

\$2,502

For use with 42"-Wide Tables

60"-Wide Monitor Panel

Add **-MP48**

\$2,717

For use with 48"-Wide Tables

### EDGE PROFILE



Two4Six Glass Edge

### GENERAL INFORMATION

- Tops are 1-1/8"-thick with 3/16"-thick hardwood edge band
- Seating capacity based on 27" per person
- Overall table height 42"
- Standard with quarter cut veneer
- Must be anchored to a wall, with or without Slab Base
- One section of wire management channel provided per table
- Monitor Panel will be 12" wider than the table specified

- Monitor Panel mounts directly to the wall
- Monitor Panel is 78" high
- Monitor panel available in Paint or Veneer Finish options only
- Not available with Power Matrix
- Only Woodgrain Laminate options are available for the Racetrack Base
- Racetrack Bases have a removable access door

#### REQUIRED INFORMATION (ORDER CANNOT BE ENTERED WITHOUT THIS INFORMATION)

See appendix pages vi-vii for surface material options.

- Choose Glass Finish
- Choose Paint Finish, if -PS Slab Base is specified
- Choose Veneer Finish, if -V Slab Base is specified
- Choose Metal Finish
- Choose ABS Finish or Coordinating Woodgrain Edgeband finish if -RCL base specified
- Choose Sub-Top Finish: Paint Finish or Wood Species & Finish



# SOLID SURFACE TOP



D-SHAPE TOP

### BASE KEY

OF Open Frame

RCL Laminate Racetrack Base  
RCP Painted Racetrack Base  
RCV Veneer Racetrack Base

## D-SHAPE TOP // SLAB BASE // STANDING HEIGHT

MODEL #	LENGTH	WIDTH	HEIGHT	SEATING CAPACITY	-OF	-RCL	-RCP	-RCV
TFN-3060-SS [ ]	60	30	42	5	6,744	-	-	-
TFN-3066-SS [ ]	66	30	42	5	7,339	-	-	-
TFN-3072-SS [ ]	72	30	42	5	7,560	-	-	-
TFN-3078-SS [ ]	78	30	42	5	8,318	-	-	-
TFN-3084-SS [ ]	84	30	42	7	8,555	-	-	-
TFN-3090-SS [ ]	90	30	42	7	9,246	-	-	-
TFN-3096-SS [ ]	96	30	42	7	9,492	-	-	-
TFN-3660-SS [ ]	60	36	42	5	7,076	-	-	-
TFN-3666-SS [ ]	66	36	42	5	7,725	-	-	-
TFN-3672-SS [ ]	72	36	42	5	7,981	-	-	-
TFN-3678-SS [ ]	78	36	42	5	8,806	-	-	-
TFN-3684-SS [ ]	84	36	42	7	9,080	-	-	-
TFN-3690-SS [ ]	90	36	42	7	9,838	-	-	-
TFN-3696-SS [ ]	96	36	42	7	10,123	-	-	-
TFN-4260-SS [ ]	60	42	42	5	8,056	-	-	-
TFN-4266-SS [ ]	66	42	42	5	8,819	-	-	-
TFN-4272-SS [ ]	72	42	42	5	9,135	9,135	9,825	10,416
TFN-4278-SS [ ]	78	42	42	5	10,105	10,105	10,842	11,476
TFN-4284-SS [ ]	84	42	42	7	10,442	10,442	11,179	11,813
TFN-4290-SS [ ]	90	42	42	7	11,339	11,339	12,115	12,781
TFN-4296-SS [ ]	96	42	42	7	11,694	11,694	12,470	13,135
TFN-4860-SS [ ]	60	48	42	5	8,706	-	-	-
TFN-4866-SS [ ]	66	48	42	5	9,557	-	-	-
TFN-4872-SS [ ]	72	48	42	5	9,922	9,922	10,635	11,247
TFN-4878-SS [ ]	78	48	42	5	11,003	11,003	11,764	12,419
TFN-4884-SS [ ]	84	48	42	7	11,394	11,394	12,155	12,811
TFN-4890-SS [ ]	90	48	42	7	12,397	12,397	13,199	13,888
TFN-4896-SS [ ]	96	48	42	7	12,807	12,807	13,609	14,297

[ ] Slab Base, Specify Paint (-PS) or Veneer (-V)

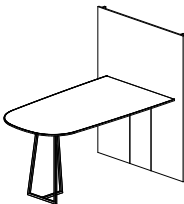

Shown with optional Monitor Panel (-MP)

### OPTIONS

Power & Data Options

### CODE

### PRICE

### NOTES

See pages 121-131

Remove Slab Base

Add **-WM**

Deduct \$699

Mounted directly to wall

### Polished Chrome Finish Options:

Polished Chrome Open Frame Base

Add **-PCOF-TWD**

\$1,654

### Monitor Panel Options:

42"-Wide Monitor Panel

Add **-MP30**

\$2,076

For use with 30"-Wide Tables

48"-Wide Monitor Panel

Add **-MP36**

\$2,288

For use with 36"-Wide Tables

54"-Wide Monitor Panel

Add **-MP42**

\$2,502

For use with 42"-Wide Tables

60"-Wide Monitor Panel

Add **-MP48**

\$2,717

For use with 48"-Wide Tables

### EDGE PROFILE

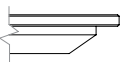

Two4Six Solid Surface Edge

### GENERAL INFORMATION

- Seating capacity based on 27" per person
- Overall table height 42"
- Standard with quarter cut veneer
- Must be anchored to a wall, with or without Slab Base
- One section of wire management channel provided per table
- Monitor Panel will be 12" wider than the table specified

- Monitor Panel mounts directly to the wall
- Monitor Panel is 78" high
- Monitor panel available in Paint or Veneer Finish options only
- Not available with Power Matrix
- Only Woodgrain Laminate options are available for the Racetrack Base
- Racetrack Bases have a removable access door

### REQUIRED INFORMATION (ORDER CANNOT BE ENTERED WITHOUT THIS INFORMATION)

See appendix pages vi-vii for surface material options.

- Choose Solid Surface Finish
- Choose Paint Finish, if -PS Slab Base is specified
- Choose Veneer Finish, if -V Slab Base is specified
- Choose Metal Finish
- Choose ABS Finish or Coordinating Woodgrain Edgeband finish if -RCL base specified



## VENEER TOP WITH HARDWOOD EDGE



RECTANGLE TOP

## BASE KEY

OF Open Frame

RCL Laminate Racetrack Base  
RCP Painted Racetrack Base  
RCV Veneer Racetrack Base

## RECTANGLE TOP TABLES

MODEL #	LENGTH	WIDTH	HEIGHT	SEATING CAPACITY	-OF	-RCL	-RCP	-RCV
TFP-3060-V	60	30	42	4	4,353	-	-	-
TFP-3660-V	60	36	42	4	4,557	-	-	-
TFP-4260-V	60	42	42	4	5,176	-	-	-
TFP-4860-V	60	48	42	4	5,583	-	-	-
TFP-3066-V	66	30	42	4	4,730	-	-	-
TFP-3666-V	66	36	42	4	4,967	-	-	-
TFP-4266-V	66	42	42	4	5,658	-	-	-
TFP-4866-V	66	48	42	4	6,119	-	-	-
TFP-3072-V	72	30	42	6	4,865	-	-	-
TFP-3672-V	72	36	42	6	5,123	-	-	-
TFP-4272-V	72	42	42	6	5,851	5,851	6,252	6,666
TFP-4872-V	72	48	42	6	6,343	6,343	6,758	7,185
TFP-3078-V	78	30	42	6	5,347	-	-	-
TFP-3678-V	78	36	42	6	5,646	-	-	-
TFP-4278-V	78	42	42	6	6,464	6,464	6,893	7,335
TFP-4878-V	78	48	42	6	7,023	7,023	7,467	7,924
TFP-3084-V	84	30	42	8	5,491	-	-	-
TFP-3684-V	84	36	42	8	5,813	-	-	-
TFP-4284-V	84	42	42	8	6,671	6,671	7,100	7,542
TFP-4884-V	84	48	42	8	7,263	7,263	7,707	8,164
TFP-3090-V	90	30	42	8	5,928	-	-	-
TFP-3690-V	90	36	42	8	6,291	-	-	-
TFP-4290-V	90	42	42	8	7,235	7,235	7,686	8,151
TFP-4890-V	90	48	42	8	7,893	7,893	8,359	8,841
TFP-3096-V	96	30	42	8	6,079	-	-	-
TFP-3696-V	96	36	42	8	6,466	-	-	-
TFP-4296-V	96	42	42	8	7,452	7,452	7,903	8,368
TFP-4896-V	96	48	42	8	8,145	8,145	8,611	9,092
TFP-42102-V	102	42	42	8	-	8,097	8,573	9,064
TFP-48102-V	102	48	42	8	-	8,863	9,356	9,864
TFP-42108-V	108	42	42	10	-	8,326	8,802	9,293
TFP-48108-V	108	48	42	10	-	9,130	9,622	10,130
TFP-42114-V	114	42	42	10	-	9,006	9,507	10,024
TFP-48114-V	114	48	42	10	-	9,890	10,409	10,943
TFP-42120-V	120	42	42	10	-	9,247	9,748	10,265
TFP-48120-V	120	48	42	10	-	10,171	10,689	11,224
TFP-42132-V	132	42	42	10	-	10,137	10,659	11,197
TFP-48132-V	132	48	42	10	-	11,179	11,719	12,275
TFP-42144-V	144	42	42	12	-	11,065	11,608	12,168
TFP-48144-V	144	48	42	12	-	12,233	12,794	13,373



# VENEER TOP WITH HARDWOOD EDGE

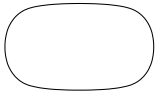

SOFT RECTANGLE TOP

**BASE KEY**

OF Open Frame

RCL Laminate Racetrack Base  
 RCP Painted Racetrack Base  
 RCV Veneer Racetrack Base

**SOFT RECTANGLE TOP TABLES**

MODEL #	LENGTH	WIDTH	HEIGHT	SEATING CAPACITY	-OF	-RCL	-RCP	-RCV
TFV-3060-V	60	30	42	4	4,353	-	-	-
TFV-3660-V	60	36	42	4	4,557	-	-	-
TFV-4260-V	60	42	42	4	5,176	-	-	-
TFV-4860-V	60	48	42	4	5,583	-	-	-
TFV-3066-V	66	30	42	4	4,730	-	-	-
TFV-3666-V	66	36	42	4	4,967	-	-	-
TFV-4266-V	66	42	42	4	5,658	-	-	-
TFV-4866-V	66	48	42	4	6,119	-	-	-
TFV-3072-V	72	30	42	6	4,865	-	-	-
TFV-3672-V	72	36	42	6	5,123	-	-	-
TFV-4272-V	72	42	42	6	5,851	5,851	6,252	6,666
TFV-4872-V	72	48	42	6	6,343	6,343	6,758	7,185
TFV-3078-V	78	30	42	6	5,347	-	-	-
TFV-3678-V	78	36	42	6	5,646	-	-	-
TFV-4278-V	78	42	42	6	6,464	6,464	6,893	7,335
TFV-4878-V	78	48	42	6	7,023	7,023	7,467	7,924
TFV-3084-V	84	30	42	8	5,491	-	-	-
TFV-3684-V	84	36	42	8	5,813	-	-	-
TFV-4284-V	84	42	42	8	6,671	6,671	7,100	7,542
TFV-4884-V	84	48	42	8	7,263	7,263	7,707	8,164
TFV-3090-V	90	30	42	8	5,928	-	-	-
TFV-3690-V	90	36	42	8	6,291	-	-	-
TFV-4290-V	90	42	42	8	7,235	7,235	7,686	8,151
TFV-4890-V	90	48	42	8	7,893	7,893	8,359	8,841
TFV-3096-V	96	30	42	8	6,079	-	-	-
TFV-3696-V	96	36	42	8	6,466	-	-	-
TFV-4296-V	96	42	42	8	7,452	7,452	7,903	8,368
TFV-4896-V	96	48	42	8	8,145	8,145	8,611	9,092
TFV-42102-V	102	42	42	8	-	8,097	8,573	9,064
TFV-48102-V	102	48	42	8	-	8,863	9,356	9,864
TFV-42108-V	108	42	42	10	-	8,326	8,802	9,293
TFV-48108-V	108	48	42	10	-	9,130	9,622	10,130
TFV-42114-V	114	42	42	10	-	9,006	9,507	10,024
TFV-48114-V	114	48	42	10	-	9,890	10,409	10,943
TFV-42120-V	120	42	42	10	-	9,247	9,748	10,265
TFV-48120-V	120	48	42	10	-	10,171	10,689	11,224
TFV-42132-V	132	42	42	10	-	10,137	10,659	11,197
TFV-48132-V	132	48	42	10	-	11,179	11,719	12,275
TFV-42144-V	144	42	42	12	-	11,065	11,608	12,168
TFV-48144-V	144	48	42	12	-	12,233	12,794	13,373



# VENEER TOP WITH HARDWOOD EDGE

OPTIONS	CODE	PRICE	NOTES
Power & Data Options			See pages 121-131
<b>Polished Chrome Finish Options:</b>			
Polished Chrome Open Frame Base	Add -PCOF-TWE	\$2,717	
<b>Multi-Section Tops:</b>			
102", 108", 114" and 120" one-piece tops split into two sections	Specify -2	\$795	Note: Power Matrix (center of table location only) cannot be specified when this option is selected

## EDGE PROFILE

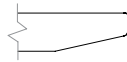

Two4Six Cutback Edge

## GENERAL INFORMATION

- Seating capacity based on 27" per person
- Overall table height 42"
- Standard with quarter cut veneer
- One section of wire management channel provided per table
- Racetrack Bases have a removable access door

### REQUIRED INFORMATION (ORDER CANNOT BE ENTERED WITHOUT THIS INFORMATION)

See appendix pages vi-vii for surface material options.

- Choose Veneer Finish
- Choose Metal Finish
- Choose ABS Finish or Coordinating Woodgrain Edgeband finish if -RCL base specified





# INSET LAMINATE TOP WITH HARDWOOD EDGE



RECTANGLE TOP

**BASE KEY**

OF Open Frame

RCL Laminate Racetrack Base  
 RCP Painted Racetrack Base  
 RCV Veneer Racetrack Base

**RECTANGLE TOP TABLES**

MODEL #	LENGTH	WIDTH	HEIGHT	SEATING CAPACITY	-OF	-RCL	-RCP	-RCV
TFP-3060-P	60	30	42	4	4,114	-	-	-
TFP-3660-P	60	36	42	4	4,307	-	-	-
TFP-4260-P	60	42	42	4	4,892	-	-	-
TFP-4860-P	60	48	42	4	5,276	-	-	-
TFP-3066-P	66	30	42	4	4,470	-	-	-
TFP-3666-P	66	36	42	4	4,694	-	-	-
TFP-4266-P	66	42	42	4	5,347	-	-	-
TFP-4866-P	66	48	42	4	5,783	-	-	-
TFP-3072-P	72	30	42	6	4,598	-	-	-
TFP-3672-P	72	36	42	6	4,842	-	-	-
TFP-4272-P	72	42	42	6	5,530	5,530	5,909	6,300
TFP-4872-P	72	48	42	6	5,995	5,995	6,387	6,790
TFP-3078-P	78	30	42	6	5,053	-	-	-
TFP-3678-P	78	36	42	6	5,336	-	-	-
TFP-4278-P	78	42	42	6	6,109	6,109	6,514	6,932
TFP-4878-P	78	48	42	6	6,637	6,637	7,057	7,489
TFP-3084-P	84	30	42	8	5,189	-	-	-
TFP-3684-P	84	36	42	8	5,494	-	-	-
TFP-4284-P	84	42	42	8	6,305	6,305	6,710	7,128
TFP-4884-P	84	48	42	8	6,864	6,864	7,284	7,715
TFP-3090-P	90	30	42	8	5,602	-	-	-
TFP-3690-P	90	36	42	8	5,945	-	-	-
TFP-4290-P	90	42	42	8	6,838	6,838	7,264	7,703
TFP-4890-P	90	48	42	8	7,459	7,459	7,900	8,355
TFP-3096-P	96	30	42	8	5,745	-	-	-
TFP-3696-P	96	36	42	8	6,111	-	-	-
TFP-4296-P	96	42	42	8	7,043	7,043	7,469	7,908
TFP-4896-P	96	48	42	8	7,698	7,698	8,138	8,592
TFP-42102-P	102	42	42	8	-	7,652	8,102	8,566
TFP-48102-P	102	48	42	8	-	8,376	8,842	9,322
TFP-42108-P	108	42	42	10	-	7,869	8,318	8,782
TFP-48108-P	108	48	42	10	-	8,628	9,093	9,573
TFP-42114-P	114	42	42	10	-	8,511	8,985	9,473
TFP-48114-P	114	48	42	10	-	9,347	9,837	10,342
TFP-42120-P	120	42	42	10	-	8,739	9,212	9,701
TFP-48120-P	120	48	42	10	-	9,612	10,102	10,607
TFP-42132-P	132	42	42	10	-	9,580	10,073	10,582
TFP-48132-P	132	48	42	10	-	10,565	11,075	11,600
TFP-42144-P	144	42	42	12	-	10,457	10,970	11,499
TFP-48144-P	144	48	42	12	-	11,561	12,091	12,638



# INSET LAMINATE TOP WITH HARDWOOD EDGE

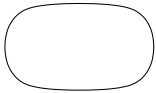

SOFT RECTANGLE TOP

**BASE KEY**

OF Open Frame

RCL Laminate Racetrack Base  
 RCP Painted Racetrack Base  
 RCV Veneer Racetrack Base

**SOFT RECTANGLE TOP TABLES**

MODEL #	LENGTH	WIDTH	HEIGHT	SEATING CAPACITY	-OF	-RCL	-RCP	-RCV
TFV-3060-P	60	30	42	4	4,114	-	-	-
TFV-3660-P	60	36	42	4	4,307	-	-	-
TFV-4260-P	60	42	42	4	4,892	-	-	-
TFV-4860-P	60	48	42	4	5,276	-	-	-
TFV-3066-P	66	30	42	4	4,470	-	-	-
TFV-3666-P	66	36	42	4	4,694	-	-	-
TFV-4266-P	66	42	42	4	5,347	-	-	-
TFV-4866-P	66	48	42	4	5,783	-	-	-
TFV-3072-P	72	30	42	6	4,598	-	-	-
TFV-3672-P	72	36	42	6	4,842	-	-	-
TFV-4272-P	72	42	42	6	5,530	5,530	5,909	6,300
TFV-4872-P	72	48	42	6	5,995	5,995	6,387	6,790
TFV-3078-P	78	30	42	6	5,053	-	-	-
TFV-3678-P	78	36	42	6	5,336	-	-	-
TFV-4278-P	78	42	42	6	6,109	6,109	6,514	6,932
TFV-4878-P	78	48	42	6	6,637	6,637	7,057	7,489
TFV-3084-P	84	30	42	8	5,189	-	-	-
TFV-3684-P	84	36	42	8	5,494	-	-	-
TFV-4284-P	84	42	42	8	6,305	6,305	6,710	7,128
TFV-4884-P	84	48	42	8	6,864	6,864	7,284	7,715
TFV-3090-P	90	30	42	8	5,602	-	-	-
TFV-3690-P	90	36	42	8	5,945	-	-	-
TFV-4290-P	90	42	42	8	6,838	6,838	7,264	7,703
TFV-4890-P	90	48	42	8	7,459	7,459	7,900	8,355
TFV-3096-P	96	30	42	8	5,745	-	-	-
TFV-3696-P	96	36	42	8	6,111	-	-	-
TFV-4296-P	96	42	42	8	7,043	7,043	7,469	7,908
TFV-4896-P	96	48	42	8	7,698	7,698	8,138	8,592
TFV-42102-P	102	42	42	8	-	7,652	8,102	8,566
TFV-48102-P	102	48	42	8	-	8,376	8,842	9,322
TFV-42108-P	108	42	42	10	-	7,869	8,318	8,782
TFV-48108-P	108	48	42	10	-	8,628	9,093	9,573
TFV-42114-P	114	42	42	10	-	8,511	8,985	9,473
TFV-48114-P	114	48	42	10	-	9,347	9,837	10,342
TFV-42120-P	120	42	42	10	-	8,739	9,212	9,701
TFV-48120-P	120	48	42	10	-	9,612	10,102	10,607
TFV-42132-P	132	42	42	10	-	9,580	10,073	10,582
TFV-48132-P	132	48	42	10	-	10,565	11,075	11,600
TFV-42144-P	144	42	42	12	-	10,457	10,970	11,499
TFV-48144-P	144	48	42	12	-	11,561	12,091	12,638



# INSET LAMINATE TOP WITH HARDWOOD EDGE

OPTIONS	CODE	PRICE	NOTES
Power & Data Options			See pages 121-131
<b>Polished Chrome Finish Options:</b>			
Polished Chrome Open Frame Base	Add -PCOF-TWE	\$2,717	
<b>Multi-Section Tops:</b>			
102", 108", 114" and 120" one-piece tops split into two sections	Specify -2	\$795	Note: Power Matrix (center of table location only) cannot be specified when this option is selected

## EDGE PROFILE

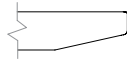

Two4Six Cutback Edge

## GENERAL INFORMATION

- Seating capacity based on 27" per person
- Overall table height 42"
- Standard with quarter cut veneer
- One section of wire management channel provided per table
- Racetrack Bases have a removable access door

### REQUIRED INFORMATION (ORDER CANNOT BE ENTERED WITHOUT THIS INFORMATION)

See appendix pages vi-vii for surface material options.

- Choose Laminate Finish
- Choose Wood Species & Finish for Hardwood Edge
- Choose Metal Finish
- Choose ABS Finish or Coordinating Woodgrain Edgeband finish if -RCL base specified



## LAMINATE TOP WITH ABS CUTBACK EDGE



RECTANGLE TOP

## BASE KEY

OF Open Frame

RCL Laminate Racetrack Base  
RCP Painted Racetrack Base  
RCV Veneer Racetrack Base

## RECTANGLE TOP TABLES

MODEL #	LENGTH	WIDTH	HEIGHT	SEATING CAPACITY	-OF	-RCL	-RCP	-RCV
TFP-3060-PA	60	30	42	4	4,114	-	-	-
TFP-3660-PA	60	36	42	4	4,307	-	-	-
TFP-4260-PA	60	42	42	4	4,892	-	-	-
TFP-4860-PA	60	48	42	4	5,276	-	-	-
TFP-3066-PA	66	30	42	4	4,470	-	-	-
TFP-3666-PA	66	36	42	4	4,694	-	-	-
TFP-4266-PA	66	42	42	4	5,347	-	-	-
TFP-4866-PA	66	48	42	4	5,783	-	-	-
TFP-3072-PA	72	30	42	6	4,598	-	-	-
TFP-3672-PA	72	36	42	6	4,842	-	-	-
TFP-4272-PA	72	42	42	6	5,530	5,530	5,909	6,300
TFP-4872-PA	72	48	42	6	5,995	5,995	6,387	6,790
TFP-3078-PA	78	30	42	6	5,053	-	-	-
TFP-3678-PA	78	36	42	6	5,336	-	-	-
TFP-4278-PA	78	42	42	6	6,109	6,109	6,514	6,932
TFP-4878-PA	78	48	42	6	6,637	6,637	7,057	7,489
TFP-3084-PA	84	30	42	8	5,189	-	-	-
TFP-3684-PA	84	36	42	8	5,494	-	-	-
TFP-4284-PA	84	42	42	8	6,305	6,305	6,710	7,128
TFP-4884-PA	84	48	42	8	6,864	6,864	7,284	7,715
TFP-3090-PA	90	30	42	8	5,602	-	-	-
TFP-3690-PA	90	36	42	8	5,945	-	-	-
TFP-4290-PA	90	42	42	8	6,838	6,838	7,264	7,703
TFP-4890-PA	90	48	42	8	7,459	7,459	7,900	8,355
TFP-3096-PA	96	30	42	8	5,745	-	-	-
TFP-3696-PA	96	36	42	8	6,111	-	-	-
TFP-4296-PA	96	42	42	8	7,043	7,043	7,469	7,908
TFP-4896-PA	96	48	42	8	7,698	7,698	8,138	8,592
TFP-42102-PA	102	42	42	8	-	7,652	8,102	8,566
TFP-48102-PA	102	48	42	8	-	8,376	8,842	9,322
TFP-42108-PA	108	42	42	10	-	7,869	8,318	8,782
TFP-48108-PA	108	48	42	10	-	8,628	9,093	9,573
TFP-42114-PA	114	42	42	10	-	8,511	8,985	9,473
TFP-48114-PA	114	48	42	10	-	9,347	9,837	10,342
TFP-42120-PA	120	42	42	10	-	8,739	9,212	9,701
TFP-48120-PA	120	48	42	10	-	9,612	10,102	10,607
TFP-42132-PA	132	42	42	10	-	9,580	10,073	10,582
TFP-48132-PA	132	48	42	10	-	10,565	11,075	11,600
TFP-42144-PA	144	42	42	12	-	10,457	10,970	11,499
TFP-48144-PA	144	48	42	12	-	11,561	12,091	12,638



# LAMINATE TOP WITH ABS CUTBACK EDGE

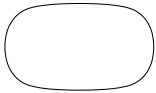

SOFT RECTANGLE TOP

**BASE KEY**

OF Open Frame

RCL Laminate Racetrack Base  
 RCP Painted Racetrack Base  
 RCV Veneer Racetrack Base

**SOFT RECTANGLE TOP TABLES**

MODEL #	LENGTH	WIDTH	HEIGHT	SEATING CAPACITY	-OF	-RCL	-RCP	-RCV
TFV-3060-PA	60	30	42	4	4,114	-	-	-
TFV-3660-PA	60	36	42	4	4,307	-	-	-
TFV-4260-PA	60	42	42	4	4,892	-	-	-
TFV-4860-PA	60	48	42	4	5,276	-	-	-
TFV-3066-PA	66	30	42	4	4,470	-	-	-
TFV-3666-PA	66	36	42	4	4,694	-	-	-
TFV-4266-PA	66	42	42	4	5,347	-	-	-
TFV-4866-PA	66	48	42	4	5,783	-	-	-
TFV-3072-PA	72	30	42	6	4,598	-	-	-
TFV-3672-PA	72	36	42	6	4,842	-	-	-
TFV-4272-PA	72	42	42	6	5,530	5,530	5,909	6,300
TFV-4872-PA	72	48	42	6	5,995	5,995	6,387	6,790
TFV-3078-PA	78	30	42	6	5,053	-	-	-
TFV-3678-PA	78	36	42	6	5,336	-	-	-
TFV-4278-PA	78	42	42	6	6,109	6,109	6,514	6,932
TFV-4878-PA	78	48	42	6	6,637	6,637	7,057	7,489
TFV-3084-PA	84	30	42	8	5,189	-	-	-
TFV-3684-PA	84	36	42	8	5,494	-	-	-
TFV-4284-PA	84	42	42	8	6,305	6,305	6,710	7,128
TFV-4884-PA	84	48	42	8	6,864	6,864	7,284	7,715
TFV-3090-PA	90	30	42	8	5,602	-	-	-
TFV-3690-PA	90	36	42	8	5,945	-	-	-
TFV-4290-PA	90	42	42	8	6,838	6,838	7,264	7,703
TFV-4890-PA	90	48	42	8	7,459	7,459	7,900	8,355
TFV-3096-PA	96	30	42	8	5,745	-	-	-
TFV-3696-PA	96	36	42	8	6,111	-	-	-
TFV-4296-PA	96	42	42	8	7,043	7,043	7,469	7,908
TFV-4896-PA	96	48	42	8	7,698	7,698	8,138	8,592
TFV-42102-PA	102	42	42	8	-	7,652	8,102	8,566
TFV-48102-PA	102	48	42	8	-	8,376	8,842	9,322
TFV-42108-PA	108	42	42	10	-	7,869	8,318	8,782
TFV-48108-PA	108	48	42	10	-	8,628	9,093	9,573
TFV-42114-PA	114	42	42	10	-	8,511	8,985	9,473
TFV-48114-PA	114	48	42	10	-	9,347	9,837	10,342
TFV-42120-PA	120	42	42	10	-	8,739	9,212	9,701
TFV-48120-PA	120	48	42	10	-	9,612	10,102	10,607
TFV-42132-PA	132	42	42	10	-	9,580	10,073	10,582
TFV-48132-PA	132	48	42	10	-	10,565	11,075	11,600
TFV-42144-PA	144	42	42	12	-	10,457	10,970	11,499
TFV-48144-PA	144	48	42	12	-	11,561	12,091	12,638



# LAMINATE TOP WITH ABS CUTBACK EDGE

OPTIONS	CODE	PRICE	NOTES
Power & Data Options			See pages 121-131
<b>Polished Chrome Finish Options:</b>			
Polished Chrome Open Frame Base	Add -PCOF-TWE	\$2,717	
<b>Multi-Section Tops:</b>			
102", 108", 114" and 120" one-piece tops split into two sections	Specify -2	\$795	Note: Power Matrix (center of table location only) cannot be specified when this option is selected

## EDGE PROFILE

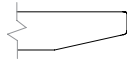

Two4Six Cutback Edge

## GENERAL INFORMATION

- Seating capacity based on 27" per person
- Overall table height 42"
- Standard with quarter cut veneer
- One section of wire management channel provided per table
- Racetrack Bases have a removable access door

### REQUIRED INFORMATION (ORDER CANNOT BE ENTERED WITHOUT THIS INFORMATION)

See appendix pages vi-vii for surface material options.

- Choose Laminate Finish
- Choose ABS Edge Finish
- Choose Metal Finish
- Choose ABS Finish or Coordinating Woodgrain Edgeband finish if -RCL base specified



## LAMINATE TOP WITH ABS SQUARE EDGE



RECTANGLE TOP

## BASE KEY

OF Open Frame

RCL Laminate Racetrack Base  
RCP Painted Racetrack Base  
RCV Veneer Racetrack Base

## RECTANGLE TOP TABLES

MODEL #	LENGTH	WIDTH	HEIGHT	SEATING CAPACITY	-OF	-RCL	-RCP	-RCV
TFP-3060-PE	60	30	42	4	3,701	-	-	-
TFP-3660-PE	60	36	42	4	3,874	-	-	-
TFP-4260-PE	60	42	42	4	4,400	-	-	-
TFP-4860-PE	60	48	42	4	4,746	-	-	-
TFP-3066-PE	66	30	42	4	4,021	-	-	-
TFP-3666-PE	66	36	42	4	4,222	-	-	-
TFP-4266-PE	66	42	42	4	4,810	-	-	-
TFP-4866-PE	66	48	42	4	5,202	-	-	-
TFP-3072-PE	72	30	42	6	4,136	-	-	-
TFP-3672-PE	72	36	42	6	4,355	-	-	-
TFP-4272-PE	72	42	42	6	4,974	4,974	5,315	5,667
TFP-4872-PE	72	48	42	6	5,392	5,392	5,745	6,108
TFP-3078-PE	78	30	42	6	4,545	-	-	-
TFP-3678-PE	78	36	42	6	4,800	-	-	-
TFP-4278-PE	78	42	42	6	5,495	5,495	5,860	6,235
TFP-4878-PE	78	48	42	6	5,970	5,970	6,347	6,736
TFP-3084-PE	84	30	42	8	4,668	-	-	-
TFP-3684-PE	84	36	42	8	4,942	-	-	-
TFP-4284-PE	84	42	42	8	5,671	5,671	6,035	6,411
TFP-4884-PE	84	48	42	8	6,174	6,174	6,551	6,940
TFP-3090-PE	90	30	42	8	5,039	-	-	-
TFP-3690-PE	90	36	42	8	5,348	-	-	-
TFP-4290-PE	90	42	42	8	6,150	6,150	6,534	6,929
TFP-4890-PE	90	48	42	8	6,710	6,710	7,106	7,515
TFP-3096-PE	96	30	42	8	5,168	-	-	-
TFP-3696-PE	96	36	42	8	5,497	-	-	-
TFP-4296-PE	96	42	42	8	6,335	6,335	6,718	7,113
TFP-4896-PE	96	48	42	8	6,924	6,924	7,320	7,729
TFP-42102-PE	102	42	42	8	-	6,883	7,288	7,705
TFP-48102-PE	102	48	42	8	-	7,534	7,953	8,385
TFP-42108-PE	108	42	42	10	-	7,078	7,482	7,900
TFP-48108-PE	108	48	42	10	-	7,761	8,179	8,611
TFP-42114-PE	114	42	42	10	-	7,656	8,081	8,521
TFP-48114-PE	114	48	42	10	-	8,407	8,848	9,302
TFP-42120-PE	120	42	42	10	-	7,860	8,286	8,726
TFP-48120-PE	120	48	42	10	-	8,646	9,086	9,541
TFP-42132-PE	132	42	42	10	-	8,617	9,061	9,518
TFP-48132-PE	132	48	42	10	-	9,503	9,962	10,434
TFP-42144-PE	144	42	42	12	-	9,406	9,867	10,343
TFP-48144-PE	144	48	42	12	-	10,399	10,875	11,368



## LAMINATE TOP WITH ABS SQUARE EDGE

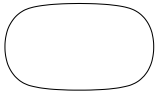

SOFT RECTANGLE TOP

## BASE KEY

OF Open Frame

RCL Laminate Racetrack Base  
RCP Painted Racetrack Base  
RCV Veneer Racetrack Base

## SOFT RECTANGLE TOP TABLES

MODEL #	LENGTH	WIDTH	HEIGHT	SEATING CAPACITY	-OF	-RCL	-RCP	-RCV
TFV-3060-PE	60	30	42	4	3,701	-	-	-
TFV-3660-PE	60	36	42	4	3,874	-	-	-
TFV-4260-PE	60	42	42	4	4,400	-	-	-
TFV-4860-PE	60	48	42	4	4,746	-	-	-
TFV-3066-PE	66	30	42	4	4,021	-	-	-
TFV-3666-PE	66	36	42	4	4,222	-	-	-
TFV-4266-PE	66	42	42	4	4,810	-	-	-
TFV-4866-PE	66	48	42	4	5,202	-	-	-
TFV-3072-PE	72	30	42	6	4,136	-	-	-
TFV-3672-PE	72	36	42	6	4,355	-	-	-
TFV-4272-PE	72	42	42	6	4,974	4,974	5,315	5,667
TFV-4872-PE	72	48	42	6	5,392	5,392	5,745	6,108
TFV-3078-PE	78	30	42	6	4,545	-	-	-
TFV-3678-PE	78	36	42	6	4,800	-	-	-
TFV-4278-PE	78	42	42	6	5,495	5,495	5,860	6,235
TFV-4878-PE	78	48	42	6	5,970	5,970	6,347	6,736
TFV-3084-PE	84	30	42	8	4,668	-	-	-
TFV-3684-PE	84	36	42	8	4,942	-	-	-
TFV-4284-PE	84	42	42	8	5,671	5,671	6,035	6,411
TFV-4884-PE	84	48	42	8	6,174	6,174	6,551	6,940
TFV-3090-PE	90	30	42	8	5,039	-	-	-
TFV-3690-PE	90	36	42	8	5,348	-	-	-
TFV-4290-PE	90	42	42	8	6,150	6,150	6,534	6,929
TFV-4890-PE	90	48	42	8	6,710	6,710	7,106	7,515
TFV-3096-PE	96	30	42	8	5,168	-	-	-
TFV-3696-PE	96	36	42	8	5,497	-	-	-
TFV-4296-PE	96	42	42	8	6,335	6,335	6,718	7,113
TFV-4896-PE	96	48	42	8	6,924	6,924	7,320	7,729
TFV-42102-PE	102	42	42	8	-	6,883	7,288	7,705
TFV-48102-PE	102	48	42	8	-	7,534	7,953	8,385
TFV-42108-PE	108	42	42	10	-	7,078	7,482	7,900
TFV-48108-PE	108	48	42	10	-	7,761	8,179	8,611
TFV-42114-PE	114	42	42	10	-	7,656	8,081	8,521
TFV-48114-PE	114	48	42	10	-	8,407	8,848	9,302
TFV-42120-PE	120	42	42	10	-	7,860	8,286	8,726
TFV-48120-PE	120	48	42	10	-	8,646	9,086	9,541
TFV-42132-PE	132	42	42	10	-	8,617	9,061	9,518
TFV-48132-PE	132	48	42	10	-	9,503	9,962	10,434
TFV-42144-PE	144	42	42	12	-	9,406	9,867	10,343
TFV-48144-PE	144	48	42	12	-	10,399	10,875	11,368





# LAMINATE TOP WITH ABS SQUARE EDGE

OPTIONS	CODE	PRICE	NOTES
Power & Data Options			See pages 121-131
<b>Polished Chrome Finish Options:</b>			
Polished Chrome Open Frame Base	Add -PCOF-TWE	\$2,717	
<b>Multi-Section Tops:</b>			
102", 108", 114" and 120" one-piece tops split into two sections	Specify -2	\$795	Note: Power Matrix (center of table location only) cannot be specified when this option is selected

## EDGE PROFILE



Two4Six Square Edge

## GENERAL INFORMATION

- Seating capacity based on 27" per person
- Overall table height 42"
- Standard with quarter cut veneer
- One section of wire management channel provided per table
- Racetrack Bases have a removable access door

### REQUIRED INFORMATION (ORDER CANNOT BE ENTERED WITHOUT THIS INFORMATION)

See appendix pages vi-vii for surface material options.

- Choose Laminate Finish
- Choose ABS Edge Finish or Coordinating Woodgrain Edgeband finish
- Choose Metal Finish



## GLASS TOP



RECTANGLE TOP

## BASE KEY

OF Open Frame

RCL Laminate Racetrack Base

RCP Painted Racetrack Base

RCV Veneer Racetrack Base

## RECTANGLE TOP TABLES

MODEL #	LENGTH	WIDTH	HEIGHT	SEATING CAPACITY	-OF	-RCL	-RCP	-RCV
TFP-3060-G	60	30	42	4	6,791	-	-	-
TFP-3660-G	60	36	42	4	7,109	-	-	-
TFP-4260-G	60	42	42	4	8,075	-	-	-
TFP-4860-G	60	48	42	4	8,710	-	-	-
TFP-3066-G	66	30	42	4	7,379	-	-	-
TFP-3666-G	66	36	42	4	7,749	-	-	-
TFP-4266-G	66	42	42	4	8,827	-	-	-
TFP-4866-G	66	48	42	4	9,546	-	-	-
TFP-3072-G	72	30	42	6	7,590	-	-	-
TFP-3672-G	72	36	42	6	7,992	-	-	-
TFP-4272-G	72	42	42	6	9,128	9,128	9,754	10,399
TFP-4872-G	72	48	42	6	9,896	9,896	10,543	11,209
TFP-3078-G	78	30	42	6	8,342	-	-	-
TFP-3678-G	78	36	42	6	8,808	-	-	-
TFP-4278-G	78	42	42	6	10,084	10,084	10,754	11,443
TFP-4878-G	78	48	42	6	10,956	10,956	11,649	12,362
TFP-3084-G	84	30	42	8	8,566	-	-	-
TFP-3684-G	84	36	42	8	9,069	-	-	-
TFP-4284-G	84	42	42	8	10,407	10,407	11,076	11,766
TFP-4884-G	84	48	42	8	11,331	11,331	12,023	12,736
TFP-3090-G	90	30	42	8	9,248	-	-	-
TFP-3690-G	90	36	42	8	9,814	-	-	-
TFP-4290-G	90	42	42	8	11,287	11,287	11,991	12,716
TFP-4890-G	90	48	42	8	12,314	12,314	13,041	13,792
TFP-3096-G	96	30	42	8	9,484	-	-	-
TFP-3696-G	96	36	42	8	10,087	-	-	-
TFP-4296-G	96	42	42	8	11,626	11,626	12,329	13,055
TFP-4896-G	96	48	42	8	12,707	12,707	13,434	14,184
TFP-42102-G	102	42	42	8	-	12,632	13,374	14,140
TFP-48102-G	102	48	42	8	-	13,827	14,596	15,388
TFP-42108-G	108	42	42	10	-	12,989	13,732	14,498
TFP-48108-G	108	48	42	10	-	14,243	15,011	15,803
TFP-42114-G	114	42	42	10	-	14,050	14,831	15,638
TFP-48114-G	114	48	42	10	-	15,429	16,239	17,072
TFP-42120-G	120	42	42	10	-	14,426	15,207	16,014
TFP-48120-G	120	48	42	10	-	15,867	16,675	17,510
TFP-42132-G	132	42	42	10	-	15,814	16,629	17,468
TFP-48132-G	132	48	42	10	-	17,440	18,282	19,149
TFP-42144-G	144	42	42	12	-	17,262	18,109	18,983
TFP-48144-G	144	48	42	12	-	19,084	19,959	20,862



# GLASS TOP

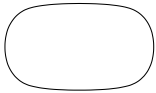

SOFT RECTANGLE TOP

**BASE KEY**

OF Open Frame

RCL Laminate Racetrack Base  
 RCP Painted Racetrack Base  
 RCV Veneer Racetrack Base

**SOFT RECTANGLE TOP TABLES**

MODEL #	LENGTH	WIDTH	HEIGHT	SEATING CAPACITY	-OF	-RCL	-RCP	-RCV
TFV-3060-G	60	30	42	4	6,791	-	-	-
TFV-3660-G	60	36	42	4	7,109	-	-	-
TFV-4260-G	60	42	42	4	8,075	-	-	-
TFV-4860-G	60	48	42	4	8,710	-	-	-
TFV-3066-G	66	30	42	4	7,379	-	-	-
TFV-3666-G	66	36	42	4	7,749	-	-	-
TFV-4266-G	66	42	42	4	8,827	-	-	-
TFV-4866-G	66	48	42	4	9,546	-	-	-
TFV-3072-G	72	30	42	6	7,590	-	-	-
TFV-3672-G	72	36	42	6	7,992	-	-	-
TFV-4272-G	72	42	42	6	9,128	9,128	9,754	10,399
TFV-4872-G	72	48	42	6	9,896	9,896	10,543	11,209
TFV-3078-G	78	30	42	6	8,342	-	-	-
TFV-3678-G	78	36	42	6	8,808	-	-	-
TFV-4278-G	78	42	42	6	10,084	10,084	10,754	11,443
TFV-4878-G	78	48	42	6	10,956	10,956	11,649	12,362
TFV-3084-G	84	30	42	8	8,566	-	-	-
TFV-3684-G	84	36	42	8	9,069	-	-	-
TFV-4284-G	84	42	42	8	10,407	10,407	11,076	11,766
TFV-4884-G	84	48	42	8	11,331	11,331	12,023	12,736
TFV-3090-G	90	30	42	8	9,248	-	-	-
TFV-3690-G	90	36	42	8	9,814	-	-	-
TFV-4290-G	90	42	42	8	11,287	11,287	11,991	12,716
TFV-4890-G	90	48	42	8	12,314	12,314	13,041	13,792
TFV-3096-G	96	30	42	8	9,484	-	-	-
TFV-3696-G	96	36	42	8	10,087	-	-	-
TFV-4296-G	96	42	42	8	11,626	11,626	12,329	13,055
TFV-4896-G	96	48	42	8	12,707	12,707	13,434	14,184
TFV-42102-G	102	42	42	8	-	12,632	13,374	14,140
TFV-48102-G	102	48	42	8	-	13,827	14,596	15,388
TFV-42108-G	108	42	42	10	-	12,989	13,732	14,498
TFV-48108-G	108	48	42	10	-	14,243	15,011	15,803
TFV-42114-G	114	42	42	10	-	14,050	14,831	15,638
TFV-48114-G	114	48	42	10	-	15,429	16,239	17,072
TFV-42120-G	120	42	42	10	-	14,426	15,207	16,014
TFV-48120-G	120	48	42	10	-	15,867	16,675	17,510
TFV-42132-G	132	42	42	10	-	15,814	16,629	17,468
TFV-48132-G	132	48	42	10	-	17,440	18,282	19,149
TFV-42144-G	144	42	42	12	-	17,262	18,109	18,983
TFV-48144-G	144	48	42	12	-	19,084	19,959	20,862



# GLASS TOP

OPTIONS	CODE	PRICE	NOTES
Power & Data Options			See pages 121-131
<b>Polished Chrome Finish Options:</b>			
Polished Chrome Open Frame Base	Add -PCOF-TWE	\$2,717	
<b>Satin Glass Options:</b>			
Satin Glass	Add -TFSG	\$661	
<b>Multi-Section Tops:</b>			
102", 108", 114" and 120" one-piece tops split into two sections	Specify -2	\$795	Note: Power Matrix (center of table location only) cannot be specified when this option is selected

## EDGE PROFILE

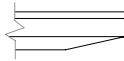

Two4Six Glass Edge

## GENERAL INFORMATION

- Tops are 1-1/8"-thick with 3/16"-thick hardwood edge band
- Seating capacity based on 27" per person
- Overall table height 42"
- Standard with quarter cut veneer
- One section of wire management channel provided per table
- Racetrack Bases have a removable access door

### REQUIRED INFORMATION (ORDER CANNOT BE ENTERED WITHOUT THIS INFORMATION)

See appendix pages vi-vii for surface material options.

- Choose Glass Finish
- Choose Metal Finish
- Choose ABS Finish or Coordinating Woodgrain Edgeband finish if -RCL base specified
- Choose Sub-Top Finish: Paint Finish or Wood Species & Finish



# SOLID SURFACE TOP



RECTANGLE TOP

**BASE KEY**

OF Open Frame

RCL Laminate Racetrack Base

RCP Painted Racetrack Base

RCV Veneer Racetrack Base

**RECTANGLE TOP TABLES**

MODEL #	LENGTH	WIDTH	HEIGHT	SEATING CAPACITY	-OF	-RCL	-RCP	-RCV
TFP-3060-SS	60	30	42	4	7,096	-	-	-
TFP-3660-SS	60	36	42	4	7,428	-	-	-
TFP-4260-SS	60	42	42	4	8,437	-	-	-
TFP-4860-SS	60	48	42	4	9,101	-	-	-
TFP-3066-SS	66	30	42	4	7,710	-	-	-
TFP-3666-SS	66	36	42	4	8,097	-	-	-
TFP-4266-SS	66	42	42	4	9,223	-	-	-
TFP-4866-SS	66	48	42	4	9,974	-	-	-
TFP-3072-SS	72	30	42	6	7,930	-	-	-
TFP-3672-SS	72	36	42	6	8,351	-	-	-
TFP-4272-SS	72	42	42	6	9,538	9,538	10,191	10,866
TFP-4872-SS	72	48	42	6	10,340	10,340	11,016	11,712
TFP-3078-SS	78	30	42	6	8,716	-	-	-
TFP-3678-SS	78	36	42	6	9,203	-	-	-
TFP-4278-SS	78	42	42	6	10,537	10,537	11,236	11,957
TFP-4878-SS	78	48	42	6	11,448	11,448	12,172	12,917
TFP-3084-SS	84	30	42	8	8,951	-	-	-
TFP-3684-SS	84	36	42	8	9,476	-	-	-
TFP-4284-SS	84	42	42	8	10,874	10,874	11,573	12,294
TFP-4884-SS	84	48	42	8	11,839	11,839	12,563	13,308
TFP-3090-SS	90	30	42	8	9,663	-	-	-
TFP-3690-SS	90	36	42	8	10,255	-	-	-
TFP-4290-SS	90	42	42	8	11,794	11,794	12,529	13,287
TFP-4890-SS	90	48	42	8	12,866	12,866	13,626	14,411
TFP-3096-SS	96	30	42	8	9,909	-	-	-
TFP-3696-SS	96	36	42	8	10,540	-	-	-
TFP-4296-SS	96	42	42	8	12,147	12,147	12,882	13,640
TFP-4896-SS	96	48	42	8	13,277	13,277	14,036	14,820
TFP-42102-SS	102	42	42	8	-	13,199	13,974	14,775
TFP-48102-SS	102	48	42	8	-	14,447	15,251	16,079
TFP-42108-SS	108	42	42	10	-	13,572	14,348	15,148
TFP-48108-SS	108	48	42	10	-	14,882	15,684	16,512
TFP-42114-SS	114	42	42	10	-	14,680	15,497	16,340
TFP-48114-SS	114	48	42	10	-	16,121	16,967	17,838
TFP-42120-SS	120	42	42	10	-	15,073	15,890	16,732
TFP-48120-SS	120	48	42	10	-	16,579	17,424	18,296
TFP-42132-SS	132	42	42	10	-	16,524	17,375	18,252
TFP-48132-SS	132	48	42	10	-	18,222	19,102	20,009
TFP-42144-SS	144	42	42	12	-	18,036	18,922	19,834
TFP-48144-SS	144	48	42	12	-	19,940	20,855	21,798



## SOLID SURFACE TOP

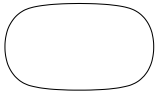

SOFT RECTANGLE TOP

## BASE KEY

OF Open Frame

RCL Laminate Racetrack Base

RCP Painted Racetrack Base

RCV Veneer Racetrack Base

## SOFT RECTANGLE TOP TABLES

MODEL #	LENGTH	WIDTH	HEIGHT	SEATING CAPACITY	-OF	-RCL	-RCP	-RCV
TFV-3060-SS	60	30	42	4	7,096	-	-	-
TFV-3660-SS	60	36	42	4	7,428	-	-	-
TFV-4260-SS	60	42	42	4	8,437	-	-	-
TFV-4860-SS	60	48	42	4	9,101	-	-	-
TFV-3066-SS	66	30	42	4	7,710	-	-	-
TFV-3666-SS	66	36	42	4	8,097	-	-	-
TFV-4266-SS	66	42	42	4	9,223	-	-	-
TFV-4866-SS	66	48	42	4	9,974	-	-	-
TFV-3072-SS	72	30	42	6	7,930	-	-	-
TFV-3672-SS	72	36	42	6	8,351	-	-	-
TFV-4272-SS	72	42	42	6	9,538	9,538	10,191	10,866
TFV-4872-SS	72	48	42	6	10,340	10,340	11,016	11,712
TFV-3078-SS	78	30	42	6	8,716	-	-	-
TFV-3678-SS	78	36	42	6	9,203	-	-	-
TFV-4278-SS	78	42	42	6	10,537	10,537	11,236	11,957
TFV-4878-SS	78	48	42	6	11,448	11,448	12,172	12,917
TFV-3084-SS	84	30	42	8	8,951	-	-	-
TFV-3684-SS	84	36	42	8	9,476	-	-	-
TFV-4284-SS	84	42	42	8	10,874	10,874	11,573	12,294
TFV-4884-SS	84	48	42	8	11,839	11,839	12,563	13,308
TFV-3090-SS	90	30	42	8	9,663	-	-	-
TFV-3690-SS	90	36	42	8	10,255	-	-	-
TFV-4290-SS	90	42	42	8	11,794	11,794	12,529	13,287
TFV-4890-SS	90	48	42	8	12,866	12,866	13,626	14,411
TFV-3096-SS	96	30	42	8	9,909	-	-	-
TFV-3696-SS	96	36	42	8	10,540	-	-	-
TFV-4296-SS	96	42	42	8	12,147	12,147	12,882	13,640
TFV-4896-SS	96	48	42	8	13,277	13,277	14,036	14,820
TFV-42102-SS	102	42	42	8	-	13,199	13,974	14,775
TFV-48102-SS	102	48	42	8	-	14,447	15,251	16,079
TFV-42108-SS	108	42	42	10	-	13,572	14,348	15,148
TFV-48108-SS	108	48	42	10	-	14,882	15,684	16,512
TFV-42114-SS	114	42	42	10	-	14,680	15,497	16,340
TFV-48114-SS	114	48	42	10	-	16,121	16,967	17,838
TFV-42120-SS	120	42	42	10	-	15,073	15,890	16,732
TFV-48120-SS	120	48	42	10	-	16,579	17,424	18,296
TFV-42132-SS	132	42	42	10	-	16,524	17,375	18,252
TFV-48132-SS	132	48	42	10	-	18,222	19,102	20,009
TFV-42144-SS	144	42	42	12	-	18,036	18,922	19,834
TFV-48144-SS	144	48	42	12	-	19,940	20,855	21,798



# SOLID SURFACE TOP

OPTIONS	CODE	PRICE	NOTES
Power & Data Options			See pages 121-131
<b>Polished Chrome Finish Options:</b>			
Polished Chrome Open Frame Base	Add -PCOF-TWE	\$2,717	
<b>Multi-Section Tops:</b>			
102", 108", 114" and 120" one-piece tops split into two sections	Specify -2	\$795	Note: Power Matrix (center of table location only) cannot be specified when this option is selected

## EDGE PROFILE

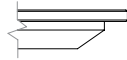

Two4Six Solid Surface Edge

## GENERAL INFORMATION

- Seating capacity based on 27" per person
- Overall table height 42"
- Standard with quarter cut veneer
- One section of wire management channel provided per table
- Racetrack Bases have a removable access door

### REQUIRED INFORMATION (ORDER CANNOT BE ENTERED WITHOUT THIS INFORMATION)

See appendix pages vi-vii for surface material options.

- Choose Solid Surface Finish
- Choose Metal Finish
- Choose ABS Finish or Coordinating Woodgrain Edgeband finish if -RCL base specified



# VENEER TOP WITH HARDWOOD EDGE



RECTANGLE TOP

**SURFACE MATERIAL KEY**

V Veneer with Hardwood Edge

**STATIONARY TABLES**

MODEL #	LENGTH	WIDTH	HEIGHT	-V
TFD-3672	72	36	29-1/2	8,870
TFD-3684	84	36	29-1/2	10,002
TFD-4284	84	42	29-1/2	11,823

**HEIGHT ADJUSTABLE TABLES**

MODEL #	LENGTH	WIDTH	-V
TFAD-3672	72	36	11,959
TFAD-3684	84	36	13,095
TFAD-4284	84	42	14,913

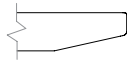
**EDGE PROFILE**

Two4Six Cutback Edge

**GENERAL INFORMATION**

- Features a cutback hardwood edge profile with 5/8" vertical edge
- Adjustable table height range: 28"-42"
- Standard with quarter cut veneer
- Tops are 1-1/8"-thick
- Available with Power Rail only

**REQUIRED INFORMATION (ORDER CANNOT BE ENTERED WITHOUT THIS INFORMATION)**

See appendix pages vi-vii for surface material options.

- Choose Veneer Finish
- Choose Metal Finish





# POWER AND DATA OPTIONS

POWER MATRIX SMALL	MODEL #	DESCRIPTION	W x D	SIMPLEX OUTLETS	BLANK	DATA*	PRICE
	PM-SM-G	Small - Glass Door	6 x 5.375	2	2	1	1,549
	PM-SM-M	Small - Metal Door	6 x 5.375	2	2	1	1,549
	PM-SM-W	Small - Wood Door	6 x 5.375	2	2	1	1,954

\*Each data faceplate includes two RJ-45 (Data) connectors

OPTIONS	CODE	PRICE	NOTES
4 Simplex Receptacles	Add <b>-FOUR</b>	No Charge	Replace AAP's with 2 additional simplex receptacles
3 Simplex Receptacles/Charging USB-A+C	Add <b>-THREE-C</b>	No Charge	Replace AAP's with 1 additional simplex receptacle and 1 charging USB-A+C
USB-A+C Charging	Add <b>-USB-C</b>	\$121 per unit	USB-A+C charger, replaces one of the simplex outlets
Polished Chrome Door	Add <b>-PD</b>	\$232 per unit	Only available with metal door option
Polished Chrome Bezel	Add <b>-PB</b>	\$330 per unit	Only available on glass, stone/quartz and laminate top tables
Field-Wired	Add <b>-FW</b>	Deduct \$45 per unit	May be required in New York City, Chicago and San Francisco. Check with an electrician for local codes and requirements.
Single Infeed Option Available	See page 124		

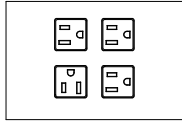

-FOUR

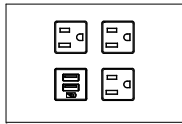

-THREE-C

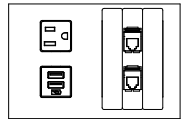

-USB-C

### GENERAL INFORMATION

- Wood species and finish will default to the same as the table top if wood door version is specified
- Glass & wood doors are 1/4" -thick, metal doors are 1/8" -thick
- Glass door is back-painted low-iron glass
- Interior body is clear anodized aluminum
- Each unit includes a 15 amp, 12' power infeed (plug in only)
- If Field-Wired option is specified, each unit includes a 6' flexible metal conduit and requires a hardwire connection
- Standard configuration: Two simplex receptacles, two RJ-45 data connectors and two single blank faceplates
- When specified on tables with laminate, glass or stone/quartz tops, each Power Matrix unit will include a metal bezel and is limited to the glass and metal door options. (-B) will be added to the model number for the bezel.
- Not available on Counter and Standing Height Media Tables
- Additional data/AV faceplate options are on page 124

### REQUIRED INFORMATION: (ORDER CANNOT BE ENTERED WITHOUT THIS INFORMATION)

See appendix pages vi-vii for surface material options.

- Choose location code & quantity from the chart on page 123
- Choose Glass Door Finish, if glass door version is specified
- Choose Metal Finish, if metal door version is specified or for the bezel finish on laminate, glass and stone/quartz tables

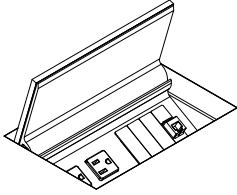

# POWER AND DATA OPTIONS

POWER MATRIX MEDIUM	MODEL #	DESCRIPTION	W x D	SIMPLEX OUTLETS	BLANK	DATA*	PRICE
	PM-MD-G	Medium - Glass Door	6 x 8.25	4	3	1	2,441
	PM-MD-M	Medium - Metal Door	6 x 8.25	4	3	1	2,441
	PM-MD-W	Medium - Wood Door	6 x 8.25	4	3	1	2,849

\*Each data faceplate includes two RJ-45 (Data) connectors

OPTIONS	CODE	PRICE	NOTES
USB-A+C Charging	Add <b>-USB-C</b>	\$121 per unit	USB-A+C charger, replaces one of the simplex outlets
Polished Chrome Door	Add <b>-PD</b>	\$312 per unit	Only available with metal door option
Polished Chrome Bezel	Add <b>-PB</b>	\$369 per unit	Only available on glass, stone/quartz and laminate top tables
Field-Wired	Add <b>-FW</b>	Deduct \$45 per unit	May be required in New York City, Chicago and San Francisco. Check with an electrician for local codes and requirements.
Single Infeed Option Available	See page 124		

### GENERAL INFORMATION

- Wood species and finish will default to the same as the table top if wood door version is specified
- Glass & wood doors are 1/4" -thick, metal doors are 1/8"-thick
- Glass door is back-painted low-iron glass
- Interior body is clear anodized aluminum
- Each unit includes a 15 amp, 12' power infeed (plug in only)
- If Field-Wired option is specified, each unit includes a 6' flexible metal conduit and requires a hardwire connection
- Standard configuration: Two simplex receptacles, two RJ-45 data connectors and two single blank faceplates
- When specified on tables with laminate, glass or stone/quartz tops, each Power Matrix unit will include a metal bezel and is limited to the glass and metal door options. (-B) will be added to the model number for the bezel.
- Not available on Counter and Standing Height Media Tables
- Additional data/AV faceplate options are on page 124

### REQUIRED INFORMATION: (ORDER CANNOT BE ENTERED WITHOUT THIS INFORMATION)

See appendix pages vi-vii for surface material options.

- Choose location code & quantity from the chart on page 123
- Choose Glass Door Finish, if glass door version is specified
- Choose Metal Finish, if metal door version is specified or for the bezel finish on laminate, glass and stone/quartz tables



# POWER AND DATA OPTIONS

LOCATION CODES	POWER MATRIX SMALL	POWER MATRIX MEDIUM	LOCATION	QUANTITY OF UNITS TO ORDER
PS-1	PM-1		One at center	1
PS-1W	PM-1W		One at wall end (Media Table only)	1
PS-2*	PM-2*		One at each end	2
PS-3*	PM-3*		One at center and one at each end	3
PS-4*	PM-4*		Four equally spaced	4

\*Not offered on Media Tables, Standing Height Tables, or Counter Height Tables

## DOOR MATERIAL AND LOCATION AVAILABILITY BY TABLE SIZE

W = Wood Door      G = Glass Door      M = Metal Door

Length	Top Sections	Power Matrix Small					Power Matrix Medium				
		PS-1	PS-1W <sup>†</sup>	PS-2*	PS-3*	PS-4*	PM-1	PM-1W <sup>†</sup>	PM-2*	PM-3*	PM-4*
48	1	W/G/M	-	-	-	-	-	-	-	-	-
54	1	W/G/M	-	-	-	-	-	-	-	-	-
60	1	W/G/M	W/G/M	-	-	-	-	W/G/M	-	-	-
66	1	W/G/M	W/G/M	-	-	-	W/G/M	W/G/M	-	-	-
72	1	W/G/M	W/G/M	-	-	-	W/G/M	W/G/M	-	-	-
84	1	W/G/M	W/G/M	-	-	-	W/G/M	W/G/M	-	-	-
90	1	W/G/M	W/G/M	-	-	-	W/G/M	W/G/M	-	-	-
96	1	W/G/M	W/G/M	-	-	-	W/G/M	W/G/M	-	-	-
102	1	W/G/M	-	W/G/M	W/G/M	-	W/G/M	-	W/G/M	W/G/M	-
102	2	-	-	W/G/M	-	-	-	-	W/G/M	-	-
108	1	W/G/M	-	W/G/M	W/G/M	-	W/G/M	-	W/G/M	W/G/M	-
108	2	-	-	W/G/M	-	-	-	-	W/G/M	-	-
114	1	W/G/M	-	W/G/M	W/G/M	-	W/G/M	-	W/G/M	W/G/M	-
114	2	-	-	W/G/M	-	-	-	-	W/G/M	-	-
120	1	W/G/M	-	W/G/M	W/G/M	-	W/G/M	-	W/G/M	W/G/M	-
120	2	-	-	W/G/M	-	-	-	-	W/G/M	-	-
132	2	-	-	W/G/M	-	W/G/M	-	-	W/G/M	-	W/G/M
144	2	-	-	W/G/M	-	W/G/M	-	-	W/G/M	-	W/G/M
156	2	-	-	W/G/M	-	W/G/M	-	-	W/G/M	-	W/G/M
168	2	-	-	W/G/M	-	W/G/M	-	-	W/G/M	-	W/G/M
180	2	-	-	W/G/M	-	W/G/M	-	-	W/G/M	-	W/G/M
192	2	-	-	W/G/M	-	W/G/M	-	-	W/G/M	-	W/G/M
192	4	-	-	W/G/M	-	W/G/M	-	-	W/G/M	-	W/G/M
204	2	-	-	W/G/M	-	W/G/M	-	-	W/G/M	-	W/G/M
204	4	-	-	W/G/M	-	W/G/M	-	-	W/G/M	-	W/G/M
216	2	-	-	W/G/M	-	W/G/M	-	-	W/G/M	-	W/G/M
216	4	-	-	W/G/M	-	W/G/M	-	-	W/G/M	-	W/G/M
228	2	-	-	W/G/M	-	W/G/M	-	-	W/G/M	-	W/G/M
228	4	-	-	W/G/M	-	W/G/M	-	-	W/G/M	-	W/G/M
240	2	-	-	W/G/M	-	W/G/M	-	-	W/G/M	-	W/G/M
240	4	-	-	W/G/M	-	W/G/M	-	-	W/G/M	-	W/G/M

<sup>†</sup> Available on Media Tables only

\*Not offered on Media Tables, Standing Height Tables, or Counter Height Tables



# POWER AND DATA OPTIONS

SINGLE INFEED OPTION	MODEL #	DESCRIPTION	PRICE
	SI-H	Single In-Feed Option, Hard-wired	576
	SI-C	Single In-Feed Option, Corded (Plug-in)	695

## GENERAL INFORMATION

- Tables 72" -120" in length include 2 duplex receptacles with the modular power system
- Tables 132" -240" in length include 3 duplex receptacles with the modular power system
- Hardwired and Corded Single In-Feed options are 7' long
- Single In-Feed option cannot be specified in conjunction with the Field-Wired (-FW) option
- Corded Single In-Feed option will require a 20-amp power outlet in the floor monument and reduces the modular electrical system in the table to a single circuit

RETRACTORS	MODEL #	DESCRIPTION	PRICE
 CR-HDMI	CR-CAT6	CAT6 Retractor	944
	CR-HDMI	HDMI Retractor	944
	CR-DISPLAY	Display Port Retractor	944
	CR-USB	Data USB Retractor	944

## GENERAL INFORMATION

- Mounting bracket and attaching hardware included with each retractor
- Can only be used with Power Matrix Small or Medium units
- Not available on square, round or soft square tables
- One Cable Pass Through Set (one top, one bottom) AAP FLDF-14 included. Double style AAP
- See page 16 for availability by table size

DATA FACEPLATES	MODEL #	DESCRIPTION	STYLE	W x H	PRICE
	FLDF-1	Blank faceplate, single height	Single	3-1/2 x 5/8	77
	FLDF-2	One VGA 15-pin HD Female to Female Gender Changer, one 3.5mm Stereo Mini Jack to Solder Tabs	Single	3-1/2 x 5/8	270
	FLDF-3	One VGA 15-pin HD Female to Female Gender Changer	Single	3-1/2 x 5/8	212
	FLDF-4	One RJ-11 Female to Punch Down - Phone	Single	3-1/2 x 5/8	212
	FLDF-5	One RJ-45 Female to Female Barrel - Data	Single	3-1/2 x 5/8	173
	FLDF-6	Two RJ-45 Female to Female Barrels, single height	Single	3-1/2 x 5/8	232
	FLDF-7	Two RJ-45 Female to Punch Down for CAT 6 - AMP	Single	3-1/2 x 5/8	328
	FLDF-8	Two RJ-45 Female to Punch Down for CAT 6 - Leviton	Single	3-1/2 x 5/8	328
	FLDF-10	Two RJ-45 Female to Punch Down for CAT 6 - Panduit	Single	3-1/2 x 5/8	328
	FLDF-11	Two USB A Female to Two USB A Female on 10" Pigtailed	Single	3-1/2 x 5/8	367
	FLDF-12	Blank faceplate, double height	Double	3-1/2 x 1-3/8	96
	FLDF-13	Two RJ-45 Female to Female Barrels, double height	Double	3-1/2 x 1-3/8	232
	FLDF-14	Cable Pass-Through Set - one top, one bottom	Double	3-1/2 x 1-3/8	405
	FLDF-15	One HDMI Female to Female Barrel	Single	3-1/2 x 5/8	270

## GENERAL INFORMATION

- All connectors and faceplates are Extron® Architectural Adapter Plates (AAP)
- Each TW-RAIL-DATA unit holds two Single Space faceplates
- Faceplates are black



# POWER AND DATA OPTIONS

FOUR PORT POWER CAP	MODEL #	SHAPE	DESCRIPTION	L x W	SIMPLEX OUTLETS	DUAL USB-A+C	DATA	ONE AT CENTER OR END	ONE AT EACH END	EQUALLY SPACED STARTING AT 96"	EQUALLY SPACED STARTING AT 132"
								-1	-2	-3	-4
 CAP-SUUS	CAP-SUUS-B-C	Racetrack	Black Simplex	9 x 2	2	2	-	1,620	3,240	4,860	6,480
	CAP-SUUS-W-C	Racetrack	White Simplex	9 x 2	2	2	-	1,620	3,240	4,860	6,480
 CAP-SUAA	CAP-SUAA-B-C	Racetrack	Black Simplex/AAP	9 x 2	1	1	2	1,345	2,690	4,035	5,380
	CAP-SUAA-W-C	Racetrack	White Simplex/Black AAP	9 x 2	1	1	2	1,345	2,690	4,035	5,380
 CAP-SSAA	CAP-SSAA-B	Racetrack	Black Simplex/AAP	9 x 2	2	-	2	1,180	2,360	3,540	4,720
	CAP-SSAA-W	Racetrack	White Simplex/Black AAP	9 x 2	2	-	2	1,180	2,360	3,540	4,720

OPTIONS	CODE	PRICE	NOTES
Polished Chrome Plate	Add <b>-PCP</b>	\$73 per unit	
Field-Wired	Add <b>-FW</b>	Add \$101 per unit	May be required in New York City, Chicago and San Francisco. Check with an electrician for local codes and requirements.

### GENERAL INFORMATION

- Data includes two single space Extron Architectural Adapter Plates (AAP's)
- Reference location chart

### REQUIRED INFORMATION: (ORDER CANNOT BE ENTERED WITHOUT THIS INFORMATION)

- See appendix pages vi-vii for surface material options.
- Choose Metal Finish (unless Polished Chrome has been specified)

TWO PORT POWER CAP	MODEL #	SHAPE	DESCRIPTION	L x W	SIMPLEX OUTLETS	DUAL USB-A+C	DATA	ONE AT CENTER OR END	ONE AT EACH END	EQUALLY SPACED STARTING AT 96"	EQUALLY SPACED STARTING AT 132"
								-1	-2	-3	-4
 CAP-SU	CAP-SU-B-C	Racetrack	Black Simplex	5.5 x 2	1	1	-	1,183	2,366	3,549	4,732
	CAP-SU-W-C	Racetrack	White Simplex	5.5 x 2	1	1	-	1,183	2,366	3,549	4,732
 CAP-SS	CAP-SS-B	Racetrack	Black Simplex	5.5 x 2	2	-	-	1,016	2,032	3,048	4,064
	CAP-SS-W	Racetrack	White Simplex	5.5 x 2	2	-	-	1,016	2,032	3,048	4,064

OPTIONS	CODE	PRICE	NOTES
Polished Chrome Plate	Add <b>-PCP</b>	\$73 per unit	
Field-Wired	Add <b>-FW</b>	Add \$101 per unit	May be required in New York City, Chicago and San Francisco. Check with an electrician for local codes and requirements.

### GENERAL INFORMATION



- Data includes two single space Extron Architectural Adapter Plates (AAP's).
- Reference location chart

### REQUIRED INFORMATION: (ORDER CANNOT BE ENTERED WITHOUT THIS INFORMATION)

- See appendix pages vi-vii for surface material options.
- Choose Metal Finish (unless Polished Chrome has been specified)

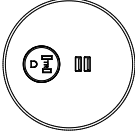

# POWER AND DATA OPTIONS

TWO PORT SOFT SQUARE, ROUND OR SQUARE POWER CAP		MODEL #	SHAPE	DESCRIPTION	L x W	SIMPLEX OUTLETS	DUAL USB-A+C	PRICE
	CAPS-SU-B-C	Soft Square	Black Simplex	5x5	1	1	1,183	
	CAPS-SU-W-C	Soft Square	White Simplex	5x5	1	1	1,183	
	CAPR-SU-B-C	Round	Black Simplex	5x5	1	1	1,183	
	CAPR-SU-W-C	Round	White Simplex	5x5	1	1	1,183	
	CAPQ-SU-B-C	Square	Black Simplex	5x5	1	1	1,183	
	CAPQ-SU-W-C	Square	White Simplex	5x5	1	1	1,183	
	CAPS-SS-B	Soft Square	Black Simplex	5x5	2	-	1,016	
	CAPS-SS-W	Soft Square	White Simplex	5x5	2	-	1,016	
	CAPR-SS-B	Round	Black Simplex	5x5	2	-	1,016	
	CAPR-SS-W	Round	White Simplex	5x5	2	-	1,016	
	CAPQ-SS-B	Square	Black Simplex	5x5	2	-	1,016	
	CAPQ-SS-W	Square	White Simplex	5x5	2	-	1,016	

OPTIONS	CODE	PRICE	NOTES
Polished Chrome Plate	Add <b>-PCP</b>	\$73 per unit	
Field-Wired	Add <b>-FW</b>	Add \$101 per unit	May be required in New York City, Chicago and San Francisco. Check with an electrician for local codes and requirements.

### GENERAL INFORMATION

- Available on Radius Square & Round Tops only
- Available at center location only

### REQUIRED INFORMATION: (ORDER CANNOT BE ENTERED WITHOUT THIS INFORMATION)

- See appendix pages vi-vii for surface material options.
- Choose Metal Finish (unless Polished Chrome has been specified)

LOCATION CODES	POWER CAP	DESCRIPTION	LOCATION	QUANTITY OF UNITS TO ORDER
CP4-1	Power Cap 4 Port Racetrack Shape	One at Center	1	
CP4-1W	Power Cap 4 Port Racetrack Shape (Media Table)	One at End (Media Table Only)	1	
CP4-2	Power Cap 4 Port Racetrack Shape	One at Each End	2	
CP4-3	Power Cap 4 Port Racetrack Shape	3 Equally Spaced (starting at 96")	3	
CP4-4	Power Cap 4 Port Racetrack Shape	4 Equally Spaced (starting at 132")	4	
CP2-1	Power Cap 2 Port Racetrack Shape	One at Center	1	
CP2-1W	Power Cap 2 Port Racetrack Shape (Media Table)	One at End (Media Table Only)	1	
CP2-2	Power Cap 2 Port Racetrack Shape	One at Each End	2	
CP2-3	Power Cap 2 Port Racetrack Shape	3 Equally Spaced (starting at 96")	3	
CP2-4	Power Cap 2 Port Racetrack Shape	4 Equally Spaced (starting at 132")	4	
CPS2-1	Power Cap 2 Port Soft Square Shape (Soft Square Tables only)	One at Center	1	
CPR2-1	Power Cap 2 Port Round Shape (Round Tables Only)	One at Center	1	
CPQ2-1	Power Cap 2 Port Square Shape (Square Tables Only)	One at Center	1	

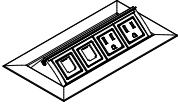

# POWER AND DATA OPTIONS

TECH NODE	MODEL #	W X D	SIMPLEX RECEPTACLES	OPEN DATA PORTS	CHARGING USB-A+C	PRICE
 PUP	PUP	8 x 4	2	2	-	565
	PUP-USB-AC	8 x 4	2	1	1	673



OPTIONS	CODE	PRICE	NOTES
Field-Wired	Add <b>-FW</b>	No Charge	May be required in New York City, Chicago and San Francisco. Check with an electrician for local codes and requirements.

### GENERAL INFORMATION

- PUP option includes two simplex receptacles and two voice/data openings
- PUP-USB-AC option includes two simplex receptacles, one USB-A+C charger and one voice/data opening
- 12' cord and a 15 amp plug-in power Infeed
- Voice/data modules must be ordered separately; contact your local AV integrator
- Default color to metal finish specified on tables (Shadow, Storm, Black, Aged Bronze, Satin Bronze and Galaxy receive Black Anodized Tech Node; Cloud, Burnished and Foil receive Clear Anodized Tech Node)
- UL Listed
- Includes a Voice/Data Adapter Kit to accept couplers and jacks when required

**REQUIRED INFORMATION: (ORDER CANNOT BE ENTERED WITHOUT THIS INFORMATION)**

- See appendix pages vi-vii for surface material options.
- Choose location code and quantity from chart on page 128



POWER SPEC	MODEL #	DESCRIPTION	PRICE
 PWR-R-B	PWR-R-B	Round Power Spec with Black Faceplate	121
	PWR-R-W	Round Power Spec with White Faceplate	121
 PWR-SQ-B	PWR-SQ-B	Square Power Spec with Black Faceplate	121
	PWR-SQ-W	Square Power Spec with White Faceplate	121

### GENERAL INFORMATION

- Includes one simplex receptable
- 12' cord

**REQUIRED INFORMATION: (ORDER CANNOT BE ENTERED WITHOUT THIS INFORMATION)**

- See appendix pages vi-vii for surface material options.
- Choose Metal Finish: Satin Nickel (SNB) or Chrome (CB)

USB SPEC	MODEL #	DESCRIPTION	PRICE
 USBC-R-B	USBC-R-B	Round Data Spec with Black Faceplate	253
	USBC-R-W	Round Data Spec with White Faceplate	253
 USBC-SQ-B	USBC-SQ-B	Square Data Spec with Black Faceplate	253
	USBC-SQ-W	Square Data Spec with White Faceplate	253

### GENERAL INFORMATION

- Includes one charging USB-A+C
- 6' cord

**REQUIRED INFORMATION: (ORDER CANNOT BE ENTERED WITHOUT THIS INFORMATION)**

- See appendix pages vi-vii for surface material options.
- Choose Metal Finish: Satin Nickel (SNB) or Chrome (CB)



# POWER AND DATA OPTIONS

GROMMET	MODEL #	DESCRIPTION	DIAMETER	PRICE
	GR	Round Grommet	2" Dia	229



OPTIONS	CODE	PRICE	NOTES
Polished Chrome Grommet	Add -PCG	\$90 per unit	

**GENERAL INFORMATION**

- Available at center location only

**REQUIRED INFORMATION: (ORDER CANNOT BE ENTERED WITHOUT THIS INFORMATION)**

See appendix pages vi-vii for surface material options.

- Choose Metal Finish: Powder Coat, Clear Anodized or Polished Chrome (upcharge applies)

POWER POLE	MODEL #	DESCRIPTION	PRICE
	TF-PP	Power Pole	961

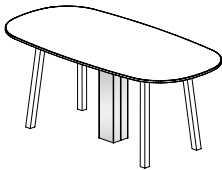

**REQUIRED INFORMATION: (ORDER CANNOT BE ENTERED WITHOUT THIS INFORMATION)**

See appendix pages vi-vii for surface material options.

- Choose Metal Finish (Clear Anodized -CA not available)

LOCATION CODES	TECH NODE	POWER SPEC	USB SPEC	ROUND GROMMET	LOCATION	QUANTITY OF UNITS TO ORDER
	TN-1	SP-1	SP-1	G-1	One at center	1
	TN-1W	SP-1W	SP-1W	G-1W	One at wall end	1
	TN-2*	SP-2	SP-2		One at each end	2
	TN-3*	SP-3	SP-3		One at center and one at each end	3
	TN-4*	SP-4	SP-4		Four equally spaced	4

\*TN-2, TN-3 and TN-4 not offered on Media Tables, Standing Height Tables, or Counter Height Tables





# POWER AND DATA OPTIONS

HARDWIRE INFEED POWER RAIL KIT	MODEL #	TOTAL # OF RAILS	ELECTRICAL OUTLETS	(2) SIMPLEX -S2	ELECTRICAL OUTLETS	(1) SIMPLEX / (1) CHARGING USB -S3
(Includes Power Rails, Hardwire Infeed and Modular Power Components)	TF-RAIL-1-H	1	2	1,385	1	1,385
	TF-RAIL-2-H	2	4	2,199	2	2,199
	TF-RAIL-3-H	3	6	3,011	3	3,011
	TF-RAIL-4-H	4	8	3,825	4	3,825
	TF-RAIL-5-H	5	10	4,638	5	4,638
	TF-RAIL-6-H	6	12	5,449	6	5,449
	TF-RAIL-7-H	7	14	6,260	7	6,260
	TF-RAIL-8-H	8	16	7,072	8	7,072

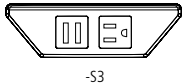
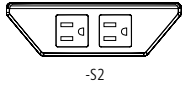

### GENERAL INFORMATION

- Includes modular power electrical system
- Hardwire infeed is 7' long
- Simplex receptacles will be white, when Burnished, Cloud or Foil powdercoat finishes are specified. Black simplex receptacles will be used for all other powdercoat finishes.
- Power Rails not available in Clear or Black Anodized

**REQUIRED INFORMATION: (ORDER CANNOT BE ENTERED WITHOUT THIS INFORMATION)**

- See appendix pages vi-vii for surface material options.
- Choose Metal Finish

CORDED INFEED POWER RAIL KIT	MODEL #	TOTAL # OF RAILS	ELECTRICAL OUTLETS	(2) SIMPLEX -S2	ELECTRICAL OUTLETS	(1) SIMPLEX / (1) CHARGING USB -S3
(Includes Power Rails, Corded Infeed and Modular Power Components)	TF-RAIL-1-C	1	2	1,506	1	1,506
	TF-RAIL-2-C	2	4	2,322	2	2,322
	TF-RAIL-3-C	3	6	3,133	3	3,133
	TF-RAIL-4-C	4	8	3,944	4	3,944
	TF-RAIL-5-C	5	10	4,756	5	4,756
	TF-RAIL-6-C	6	12	5,572	6	5,572
	TF-RAIL-7-C	7	14	6,384	7	6,384
	TF-RAIL-8-C	8	16	7,195	8	7,195

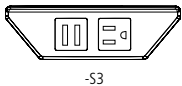
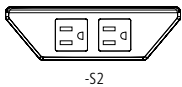

### GENERAL INFORMATION

- Includes modular power electrical system
- Corded single infeed is 7' long
- Corded Single Infeed option will require a 20amp outlet in the floor monument and reduces the modular electrical system in the table to a single circuit
- Simplex receptacles will be white, when Burnished, Cloud or Foil powdercoat finishes are specified. Black simplex receptacles will be used for all other powdercoat finishes.
- Power Rails not available in Clear or Black Anodized

**REQUIRED INFORMATION: (ORDER CANNOT BE ENTERED WITHOUT THIS INFORMATION)**

- See appendix pages vi-vii for surface material options.
- Choose Metal Finish

DATA RAIL	MODEL #	DESCRIPTION	PRICE
	TF-RAIL-DATA	Data Rail includes (1) blank faceplate and (1) dual RJ-45 faceplate	629

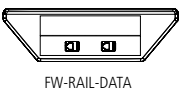

### GENERAL INFORMATION

- Data Rails not available in Clear or Black Anodized

**REQUIRED INFORMATION: (ORDER CANNOT BE ENTERED WITHOUT THIS INFORMATION)**

- See appendix pages vi-vii for surface material options.
- Choose Metal Finish



# POWER AND DATA OPTIONS

FIELD-WIRED	MODEL #	DESCRIPTION	(2) SIMPLEX -S2	(1) SIMPLEX / (1) CHARGING USB -S3
	TF-RAIL-FW	Field-Wired Power Rail	724	724

**GENERAL INFORMATION**

- Includes 6' flexible metal conduit and required a hardwire connection
- May be required in New York City, Chicago and San Francisco. Check with an electrician for local codes and requirements. A junction box will be provided when ordering the TW-RAIL-FW option.
- Power Rails not available in Clear or Black Anodized

**REQUIRED INFORMATION: (ORDER CANNOT BE ENTERED WITHOUT THIS INFORMATION)**

- See appendix pages vi-vii for surface material options.
- Choose Metal Finish

INDIVIDUAL POWER RAIL	MODEL #	DESCRIPTION	(2) SIMPLEX -S2	(1) SIMPLEX / (1) CHARGING USB -S3
	TF-RAIL	Power Rail	816	816

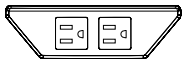

-S2



-S3

**GENERAL INFORMATION**

- Individual power rails do not include a modular power system. Each Power Rail must directly plug into a floor core with a 6'-corded 15-amp plug-in infeed. (Typically used with smaller tables, rounds, squares, soft squares, where a modular power system is not required.)
- Simplex receptacles will be white, when Burnished, Cloud or Foil powdercoat finishes are specified. Black simplex receptacles will be used for all other powdercoat finishes.
- Power Rails not available in Clear or Black Anodized

**REQUIRED INFORMATION: (ORDER CANNOT BE ENTERED WITHOUT THIS INFORMATION)**

- See appendix pages vi-vii for surface material options.
- Choose Metal Finish

CHARGING TRAC	MODEL #	TOTAL BRACKETS	# OF USB PORTS	PRICE
	TRAC-2	2	4	2,100
	TRAC-4	4	8	3,543



**GENERAL INFORMATION**

- Plug-in Infeed only
- Field Installed
- 15 amp

**REQUIRED INFORMATION: (ORDER CANNOT BE ENTERED WITHOUT THIS INFORMATION)**

- See appendix pages vi-vii for surface material options.
- Choose Metal Finish

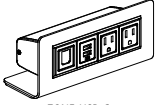

# POWER AND DATA OPTIONS

TECH ZONE	MODEL #	DESCRIPTION	SIMPLEX OUTLETS	OPEN DATA PORTS	CHARGING USB-A+C	PRICE
 ZONE-USB-C	ZONE-DATA	(2) Simplex receptacles, (2) Open data ports	2	2	-	355
	ZONE-USB-C	(2) Simplex receptacles, (1) Charging USB-A+C, (1) Open data port	2	1	1	425

### GENERAL INFORMATION

- 72" long plug-in infeed cord
- Finish is black
- Includes a Voice/Data Adapter Kit to accept couplers and jacks when required



ZONE-DATA



ZONE-USB-C

VIDEO CONFERENCE CAMERA SHELF	MODEL #	W x D	PRICE
	NEVC-1407	14 x 7	459

### GENERAL INFORMATION

- Shelf is 1/4" thick Foil powder coated aluminum and can be positioned at any height
- Field installed
- Camera shelf is not available on Freestanding and Height Adjustable Media Tables



# VENEER TOP WITH HARDWOOD EDGE

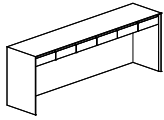

CONSOLE  
TFDC-8430

## SURFACE MATERIAL KEY

V Veneer

## CONSOLE

MODEL #	WIDTH	LENGTH	HEIGHT	# OF DRAWERS	-V
TFDC-5626	56	19	26	4 Drawers	3,529
TFDC-7026	70	19	26	5 Drawers	3,990
TFDC-8426	84	19	26	6 Drawers	4,451
TFDC-5630	56	19	30	4 Drawers	4,059
TFDC-7030	70	19	30	5 Drawers	4,589
TFDC-8430	84	19	30	6 Drawers	5,118

## GENERAL INFORMATION

- White drawer boxes with under-mount self soft-closing slides
- Overall drawer dimensions are 15" x 12.5" x 3.25". Interior drawer box dimensions are 14" x 11.5" x 2.5".
- Standard with quarter cut veneer

### REQUIRED INFORMATION (ORDER CANNOT BE ENTERED WITHOUT THIS INFORMATION)

See appendix pages vi-vii for surface material options.

- Choose Veneer Finish



# Appendix

---



# GENERAL INFORMATION

This price book supercedes all previous versions.

**Before placing your order, confirm you have all required information necessary. Lead times for orders begin after all required information is included and correct.**

## Delivery Information

We know lead times are important and sticking to them even more so. We work to maintain a 6-8 week lead time on all standard products in this book from receipt of a clean order. All orders are acknowledged with an approximate shipping date and will be invoiced with the price in effect at the date the purchase order is received. For current lead times, please review [www.nucraft.com/resources/lead-times](http://www.nucraft.com/resources/lead-times).

Shipping charges are prepaid (within the continental U.S.). Therefore, pricing is a delivered price based on normal ground transportation. If you have special instructions, need to ship by air, or are shipping to Alaska or Hawaii, contact Nucraft Customer Service. Nucraft can also help arrange to have products blanket wrapped for an additional charge. Contact the Nucraft Customer Service team or specify it on your purchase order.

**Minimum Freight Charge: Any order below \$2,900 net will be assessed a \$475 net minimum freight charge (one per order).**

Orders are subject to acquiring the materials required for manufacturing. Fulfillment can be affected by strikes, fires, embargoes and acts of government. These elements are beyond our control.

Nucraft offers a variety of services to accommodate a wide range of delivery requirements. Availability of these services is dependent on a number of factors and may not be offered with all shipments. Examples of delivery services that have additional fees include:

- Specific date
- Specific time of day, morning or afternoon
- Delivery to a warehouse before delivery to its final destination (unless product is picked up at the warehouse)

Contact the Nucraft Customer Service team for availability and pricing on these services.

## Freight Terms

Shipping charges for Nucraft products are prepaid for standard delivery in the continental United States. Standard delivery is defined as follows: Product is delivered on a 53' trailer being pulled by a long-haul tractor (total length of 85'). Facility will receive delivery Monday through Friday between the hours of 8:00 AM and 4:00 PM. Facility has docks with levelers and a fork truck for unloading. Product will be loaded on load bars two levels high. Receiving facility is responsible to have personnel on hand to unload the truck upon arrival, drivers do not unload. Delivery sites or times that do not meet these criteria may be accommodated, but will incur a charge to cover additional shipping costs. Please **notify Nucraft a minimum of two weeks prior to shipment** to arrange special services and determine additional charges.

## Storage

Nucraft has no storage facilities for finished product. If a customer cannot accept an order when it is ready for shipment, the customer must designate an alternative shipping address. If no address is provided, Nucraft may, at its discretion, transfer the product to storage. If product is transferred to an off-site storage facility, the customer may be charged for transportation to the facility and for any associated storage fees. Nucraft considers transfer of the product to a storage facility the equivalent of shipment, including invoicing and payment. Customers assume the risk of damage or loss during storage.

## Transportation Times and Delays

Third party carriers that Nucraft contracts with will make reasonable efforts to accommodate requested delivery times and dates. Scheduled delivery appointments may, however, be delayed for a variety of reasons, including inclement weather, traffic, transportation equipment problems, and delays encountered at other delivery locations along the delivery route. Nucraft does not recommend scheduling activities that depend on the delivery appointment (for example, scheduling furniture installers to install furniture the day of the delivery appointment). Nucraft shall not be liable for any costs incurred as a result of a missed delivery appointment.

## Shipment Damage Claims

Legal title to merchandise passes to the buyer upon acceptance by the carrier. Inspect all cartons upon delivery. Details of visible damage should be noted on the delivery receipt. Do not destroy packaging, transport to site, or install product if damage is found upon inspection. Inspection of products should be completed upon delivery to the receiver. If visible damage is apparent, a claim should be filed immediately with Nucraft Customer Service. If visible damage is not apparent, sign the delivery receipt "No visible damage." This will allow recourse for a concealed damage claim. Concealed damage claims must be filed within 15 days of receipt, **prior to transporting or installing any product.**

Do not destroy packing materials until shipment has been inspected. If damage is found, proceed to file a claim with Nucraft Customer Service.

**Failure to make any claims against Nucraft within 15 days shall constitute acceptance of the merchandise and a waiver of any defects, errors or shortages discovered upon inspection.**

## Cancellations

Cancellations must be reviewed by our Customer Service team. Because we build your products to order, orders cannot be cancelled once processing has begun. Processing includes but is not limited to development of shop drawings and other engineering drawings. If cancellation is approved, a processing fee of 20-100% will be assessed based on the status of the order.

## Change Order Policy

Nucraft will make every attempt to honor any reasonable change request to product provided that the request is received prior to start of production. Change orders will be accepted only if the request is made in writing and received in time to make the change. Nucraft reserves the right to increase our acknowledged price and ship date if necessary to make the requested changes. Please submit any change order request to our Customer Service team. Nucraft will assess charges to the customer as stipulated in the following:

- Standard Orders: Change orders received prior to production will be charged \$400 net to cover administrative costs.
- Special Orders: Change orders received prior to production will be charged \$400 net to cover administrative costs. There may be additional costs associated with engineering labor required for the change order.
- Change orders received after production must be evaluated by Nucraft. If approved, the charge will be \$400 net plus any restocking charges accumulated. There may be additional costs associated with engineering and/or manufacturing labor, as well as material costs, required for the change order.



# GENERAL INFORMATION

## Repair Authorization

Prior written approval is required for repairs of merchandise charged to Nucraft. Failure to do so will result in customer funded repairs.

## Payment Terms

Deposits are required at the time of order due to the custom nature of our products. See information regarding Cancellations above.

Credit terms are available to qualified customers. Please contact AR@Nucraft.com to start the application process. Note that the credit application process requires a valid sales tax exemption or resale tax certificate, Form W-9, and three current trade references.

Credit Card Payments are accepted via web portal. Please contact AR@Nucraft.com for payment instructions. Note that a 2% convenience fee will be added for using this payment method and no early pay discounts are allowed on credit card payments.

## Warranty

Nucraft Furniture is warranted to be free from defects in materials and workmanship for a period of ten years of single shift use. Limitations include:

- Mechanical Devices such as latches, casters, and other moving components are warranted for five years of the date of original delivery.
- Height adjustable components are warranted for two years of the date of original delivery.
- The following are warranted for one year of the date of original delivery:
  - Textiles
  - Electrical Components
  - Refrigeration Units
  - Custom Products not described in Nucraft's Catalogue

This warranty is applicable only if furniture is properly installed and maintained in an office environment. This warranty extends only to products manufactured and sold in North America and only to original purchasers acquiring new Nucraft product through authorized dealers or approved sellers.

During this warranty period, Nucraft's sole obligation is to repair or replace, at Nucraft's discretion, products which prove to be defective during the warranty period.

This warranty does not cover:

- Damage caused by a carrier.
- Damage from user modification, misuse, abuse, accident, or negligence.
- Customer's Own Material (COM) specified by the customer that is not a standard product offering.
- Color, grain, or texture of wood and other covering material.

**Nucraft extends no other warranties, expressed or implied, including warranty of merchantability or fitness for a particular purpose. Nucraft shall not be liable for loss of time, inconvenience, commercial loss, incidental or consequential damages.**

## Environmental Statement

Nucraft is committed to supporting responsible environmental policies and practices in all that we do. We strive for sustainability, weighing our business decisions against the costs to the ecological, social and economic systems they affect.

Our products are manufactured to meet the credit requirements of the U.S. Green Building Council's LEED rating systems in one or more of the following categories:

- Recycled Content
- Certified Wood
- Low-Emitting Materials

## Computer Aided Planning

Nucraft products and pricing are available via CET and 2020 Cap, an AutoCAD®-based space planning tool.

2020 Cap is an integrated software system developed specifically for interior designers and facility planners to enhance workplace performance. This modern suite of applications works together seamlessly, in concert. Navigate catalogs, select products, design in plan view and 3D, assign options, create worksheets and build a project where you want, when you want. Take your pick. It's dynamic and interactive. Design projects are a work in progress. And now you can perform any of the many discrete tasks that go into a project any time, any place.

For additional information, you may contact 2020 Cap direct at 800-227-0038.

Product symbols (Revit, 2D and 3D) are available on the Nucraft website at [www.nucraft.com/resources/product-symbols](http://www.nucraft.com/resources/product-symbols).

## iSpec®

Nucraft offers a free online product configuration and specification service that saves you time and allows you to be creative while leaving the nuts and bolts to someone else. No specific software is required, nor is there any learning curve. This service applies to all Nucraft products. For additional information, call 1-877-NUCRAFT and ask for the iSpec Team or log on to [www.nucraft.com/resources/ispec](http://www.nucraft.com/resources/ispec).



# FINISH INFORMATION

## Surface Materials Palette

We crafted our materials palette using the same demanding standards that distinguish our furniture. Thoughtful design and attention to every detail elevate your possibilities.

Anchored by Nucraft veneers, unrivaled for clarity, quality, and depth of finish, our collection of surface materials comprises a sophisticated set of balanced elements that supports your design vision.

Some elements have their roots in Nucraft's rich heritage. Others are new materials and reflect current trends and taste. Together, they ensure that you're ready for today and positioned well for the future. Beautifully.

## Custom Finishes

Nucraft specializes in expert custom finish matching. For a nominal upcharge we can provide custom finishes, and we are frequently asked to match the finishes of other furniture manufacturers. For finishes that appear unusual to match or for customers directly requesting a sample, a finish sample will be sent for approval prior to entering the order.

Custom finishes requiring colored varnishes to create a painted look can only be applied to Maple veneer and require one extra week in addition to the standard lead time. Nucraft's standard black finish (G82) can be applied to all Nucraft standard veneers. Walnut is the standard black veneer. Other species must be specified when ordering.

Clear coat on a special veneer requires an approved sample.

Custom finishes carry a 10% upcharge per item, per finish, capped at \$2,100 List.

Custom finish upcharges are not applied to any item that is not wood. Example: casters, ganging connectors, power options..

## Treatments

**Note: Default veneer sheen will vary per finish and product. Default finish is bolded on pages vi-vii. If no direction is provided on incoming orders, default sheen will be selected. In addition, default veneer cut is noted in the price list. If no direction is provided on incoming orders, default cut will be selected.**

**Gloss:** Gloss is a durable finish that tends to nicely mask normal wear and leaves wood grain visible to the eye. It achieves a medium gloss open pore appearance (40 – 50 sheen range). Finish numbers preceded by the letter "G" indicate a Gloss finish.

**Matte:** Like Gloss, Matte is durable, tends to nicely mask normal wear and leaves wood grain visible to the eye. It achieves a low luster, open pore appearance (10 – 20 sheen range). Finish numbers preceded by the letter "M" indicate a Matte finish.

Since each veneer type responds differently to both types of treatment, all will have a distinctive look and feel when finished. For example, a Walnut veneer with a Gloss treatment will remain much more textured than a Cherry veneer with the same treatment.

## About the Wood

All Nucraft veneers are carefully selected for uniformity of color and grain. Still, wood is a natural substance and minor variations may occur due to its own uniqueness. Because of this, the furniture you receive may not be an exact match to our samples.

Nucraft takes great pride in our finish color consistency. However, wood is a natural product that will have color variation within a single piece of furniture, as well as from one piece to the next. Other factors also affect color over time, such as exposure to light (both intensity and duration). For example, lighter finishes cause more variation in colors over time.

In cases where a returning customer wants a precise match with existing furniture, we recommend sending a sample of the existing furniture finish. Please contact Nucraft Customer Service to determine an appropriate sample. This will ensure a finish match between old and new orders. This type of order is considered a control sample. There will be a 10% upcharge on an order of this type. Due to natural aging of veneers, natural finishes may vary.

## Care and Maintenance of Wood Finishes

Our finish material is a crystal clear, urethane acrylic blend. This type of finish may be repaired in the field by a qualified refinisher.

Nucraft recommends using a damp cloth to clean your fine wood furniture. Always wipe with the grain of the wood. Should your wood furniture require a more thorough cleaning, we recommend using a mild cleaner such as Joy dish soap or Murphy's oil soap, thoroughly diluted in water (one part soap to thirty parts water). Water will not damage Nucraft's finish, but it may leave surface spots when it dries. To avoid this, dry the surface with a soft cloth after it is cleaned. Marks that cannot be removed with the cleaning methods above may be able to be removed using naphtha, a mild degreasing solvent.

Caution: while the use of polishes that contain wax, petroleum solvents or silicones may immediately enhance the "shine" of a product, it may also eventually remove the fine original finish applied in our factory. Silicone on the surface of wood may also make it very difficult to respray or refinish.

All Nucraft furniture is inspected and polished before it leaves our factory. In some instances, the packing materials may imprint on the factory polish. Cleaning and polishing the furniture once it is unpacked will normally restore the furniture to its original beauty.

In some cases, the rubber support feet used on the bottom of common office equipment (teleconferencing phones, laptops, microphones, copiers, etc.) can create unsightly marks in the surface of wood tops, due to oxidation of the lacquer finish. We suggest these machines be placed on a protective type of padding, such as felt.

Wood will fade as a result of exposure to UV light. This is particularly prevalent with light finishes. If color changes due to fading are a concern for your application, the impact can be minimized by selecting medium to dark stains for your wood surfaces. Our top coat includes a UV inhibitor which makes the finishes less prone to fading.





# FINISH INFORMATION

## Laminates

Selected Formica®, Nevamar®, and Wilsonart® laminates are available on Training Tables, Conference Tables, Conference Room Furniture and select Occasional Tables. For standard laminate and wood pricing, refer to individual item pricing columns.

## Non-Standard Laminates and Linoleums

To order a color other than those on our list (see pages vi-vii), refer to Nevamar or Formica standard grade, matte texture laminate offerings and Forbo Furniture Linoleums (excluding manufacturers' non-standard matte offering).

Nucraft can support other laminate and linoleum options beyond what can be found as standard options on pages vi-viii. For pricing, please send a request to quotes@nucraft.com.

## Care and Maintenance of Laminate and Novawrap

Laminate and Novawrap surfaces may be cleaned with a damp cloth and ordinary soap or non-abrasive household liquid detergent. Dry the surface with a clean cloth or soft paper towel to prevent streaks from appearing.

## Care and Maintenance of Metal

Metal surfaces can be wiped with a damp cloth and rubbed dry. A mild non-abrasive household liquid detergent can be used if necessary. Regular maintenance of metal components, including tightening of fasteners and light lubrication of moving parts, will extend the life of your furniture.

## Satin Etched Glass

Glass color may vary slightly on multi-piece conference table tops over 180" x 60" when satin etched glass is specified due to the iron content and etching process of the glass.

## Care and Maintenance of Glass

Clear or frosted glass may be cleaned with commercial glass cleaner. Be sure to use a lint-free cloth if cleaning the frosted side of the glass.

## Stone and Solid Surface Material

Despite its reputation for durability, natural stone can easily be broken during handling and/or installation if proper techniques are not followed. In addition, Nucraft is not responsible for the installation of natural stone or solid surface materials on its products. Therefore, installers specifically trained in the installation of these materials must be utilized to ensure a quality installation. Nucraft shall not be liable for any damages incurred during the handling and/or installation of natural stone or solid surface materials on its products.

## Care and Maintenance of Granite

Granite surfaces may be cleaned with a damp cloth and ordinary soap or non-abrasive household liquid detergent. Dry the surface with a clean cloth or soft paper towel to prevent streaks from appearing.

## Care and Maintenance of Leather

Genuine leather requires very little care. Nucraft recommends that leather be dusted regularly. If a more thorough cleaning is needed, use lukewarm water and a mild, non-abrasive soap. Generate some lather and lightly rub the surface with cheesecloth. Rinse off any soap film with clean water and towel dry. The leather may dry dull. To restore the leather to a normal gloss, rub it with a clean towel. Never use furniture polish, oil, varnish or ammonia. Saddle soap may be used to prevent the leather from becoming brittle or cracked and to maintain the original supple finish.

## Touch Up Finish Kits

Model #	Description	Price
KIT-M	Metal Kit	85
KIT-P	Paint Kit	85
KIT-S	Stain Kit	85

### REQUIRED INFORMATION: (ORDER CANNOT BE ENTERED WITHOUT THIS INFORMATION)

- Kit model number
- Quantity of kits
- Specify finish (See pages vi-vii)

### General Information:

- Touch-up kits must be ordered on a purchase order separate from Nucraft product due to Hazmat shipping

### Retrofit & Replacements

If needing a partial placement or retrofit solution, please reach out to our quote team. Grain/color matched in a set.



## WOOD FINISHES

### STANDARD

Default veneer sheen will vary per finish and were determined by a team of experts who reviewed the colorways to determine if gloss or matte best highlighted the natural characteristics of the species of wood and the color of the stain. Default finish is bolded. If no direction is provided, default sheen will be selected.

	Matte	Gloss
<b>Rift Cut Oak</b>		
Carbon	M03	<b>G03</b>
<b>Flat Cut Oak</b>		
Dune	<b>M05</b>	G05
Portobello	<b>M7413</b>	G7413
<b>Flaky Oak</b>		
Sahara	<b>M61</b>	G61
<b>Cherry</b>		
Cognac	M21	<b>G21</b>
Auburn	M93	<b>G93</b>
<b>Walnut</b>		
Marron	<b>M35</b>	G35
Mocha	<b>M33</b>	G33
Zinc	M30	<b>G30</b>
Onyx	M82	<b>G82</b>
Otter	M31	<b>G31</b>
<b>Maple</b>		
Natural Maple	M60	<b>G60</b>
<b>Linea</b>		
Oak Linea	<b>M08</b>	G08
Walnut Linea	<b>M27</b>	G27
Euro Birch Linea	<b>M09</b>	G09
Silver Birch Linea	M10	<b>G10</b>
<b>Paldao</b>		
Thicket	<b>M75</b>	G75
Paldao	<b>M76</b>	G76
Canyon	M77	<b>G77</b>

## METAL FINISHES

### Powder Coat

Aged Bronze	A8010
Black	A44
Burnished	A8009
Cloud	A8004
Foil	A8006
Galaxy	A8007
Moonlight	A87
Satin Bronze	A8011
Shadow	A8005
Storm	A8012

### Metal

Clear Anodized*	CA
Polished Chrome**	PC

\* Not available on Open Frame Base

\*\*Up-Charge applies. See specific product line pages for availability and details.

## PAINTS

Aged Bronze	S8010
Black	S44
Burnished	S88
Cloud	S8004
Foil	S8006
Galaxy	S8007
Moonlight	S87
Satin Bronze	S8011
Shadow	S8005
Storm	S8012

### Paint to Match

To request a custom paint color, contact Nucraft Customer Service. A paint sample must be matched and approved prior to order.



## STONE TOPS

Stone orders may affect lead times. Please contact Nucraft Customer Service for details.

Stone		Subtop Paint Color
Absolute Black Honed Granite	ST01	S8007
Carrara Marble	ST16	S8004
<b>Quartz   Cambria® Signature</b>		
Ainsley	STC100	S8004
Armitage	STC101	S44
Avalene	STC192	S8004
Bellingham	STC102	S8004
Berkeley	STC103	S8004
Berwyn	STC104	S8004
Blackbrook	STC105	S44
Bradshaw	STC106	S8004
Bradwell	STC107	S8004
Cambria Black	STC109	S44
Carrick	STC110	S44
Clifton	STC112	S8004
Colton	STC113	S8004
Copeland	STC200	S8004
Crowndale	STC114	S8004
Devon	STC115	S44
Fairbourne	STC116	S8004
Fieldstone	STC117	S44
Hadley	STC201	S8004
Halewood	STC119	S8004
Hermitage	STC120	S8004
Kendal	STC122	S8004
Laneshaw	STC124	S44
MacBeth	STC202	S8004
Malvern	STC125	S8004
Montgomery	STC128	S8004
New Quay	STC130	S8004
Pendle Hill	STC131	S8004
Praa Sands	STC132	S8004
Ridgegate	STC203	S8004
Rose Bay	STC133	S8004
Sandgate	STC135	S8004
Seacourt	STC204	S8004
Smithfield	STC136	S8004
Sutherland	STC138	S8004
Swanbridge	STC139	S8004
Torquay	STC140	S8004
Trafalgar	STC205	S8004
Travella	STC141	S8004
Weybourne	STC143	S8004
Whitendale	STC206	S8004
Whitney	STC144	S8004
Woodcroft	STC146	S44

## Quartz | Cambria® Luxury

Abbey	STC147	S8004
Annaleigh - Luxe	STC193	S8004
Annicca	STC148	S8004
Beckington	STC150	S8004
Bentley	STC151	S8004
Blackpool Matte	STC152	S44
Brighton	STC212	S8004
Brittanicca	STC153	S8004
Brittanicca Gold Cool	STC154	S8004
Brittanicca Gold Warm	STC155	S8004
Brittanicca Warm	STC156	S8004
Clovelly	STC158	S8004
Delamere	STC159	S44
Delgatie	STC160	S8004
Ella	STC161	S8004
Everleigh	STC162	S8004
Everleigh Warm	STC191	S8004
Gladstone	STC163	S8004
Golden Dragon	STC164	S44
Hailey	STC165	S8004
Harlow	STC166	S8004
Hemsworth	STC167	S8004
Huntley	STC168	S8004
Inverness Blakeley	STC190	S8004
Inverness Bristol Bay	STC169	S8004
Inverness Bronze	STC170	S8004
Inverness Cobalt	STC171	S8004
Inverness Everleigh	STC172	S8004
Inverness Frost	STC196	S8004
Inverness Gold	STC197	S8004
Inverness Platinum	STC173	S8004
Inverness Swansea	STC174	S8004
Ironsbridge	STC175	S8004
Iverness Frost	STC176	S8004
Iverness Gold	STC177	S8004
Lakedale	STC179	S8004
Mayfair	STC181	S8004
Mersey	STC182	S44
MonTajaj - Luxe & Satin	STC199	S8004
Notting Hill	STC183	S8004
Oakleigh	STC184	S8004
Portrush	STC185	S8004
Queen Anne	STC186	S8006
Remington Brass Satin	STC210	S44
Remington Steel Satin	STC211	S44
Skara Brae	STC187	S8004
Southport	STC188	S8004
White Cliff	STC189	S8004

## Quartz | Wilsonart

Carrara Codena	ST21	S8004
Serene	ST17	S8004



## SOLID SURFACE TOPS

Wilsonart Designer White ST11

## GLASS (SATIN OR GLOSS)

	Satin	Gloss
Black	BS	-
Clove	VS	VG
Meringue	MS	MG
Moonlight	MLS	MLG
Quill	QS	QG
Storm	STS	STG
White	WS	WG

## LAMINATES

Wood Grain Laminates <sup>§</sup>	Code	Coordinating Wood Finish	Coordinating Woodgrain Edgeband
Formica White Ash	8841-58	M8841	R8841
Formica Natural Ash	8843-58	M8843	R8843
Formica Aged Ash	8844-58	M8844	R8844
Formica Weathered Ash	8842-58	M8842	R8842
Formica Oiled Legno	8846-58	M8846	R8846
Formica Bleached Legno	8845-58	M8845	R8845
Formica Blackened Legno	8848-58	M8848	R8848
Formica Urban Planked Oak	9312-58	M9312	R9312
Formica Thermo Walnut	6402-58	M6402	R6402
Formica Smoky Brown Pear	5488-58	M5488	R5488
Formica Espresso Pear	5489-58	M5489	R5489
Formica Sand Maple	9237-58	G60	W7909
Formica Planked Coffee Oak	7413-58	M7413	F7413

<sup>§</sup>Not available on multiple piece conference tables

### Wood Grain Laminates Suitable for Multiple Piece Conference Tables

Formica Pecan Woodline	5883-58	M5883	R5883
Formica Chestnut Woodline	5884-58	M5884	R5884

### Solid Laminates

Formica Brite White	459-58	R01
Formica Dover White	7197-58	R01
Formica Pearl	934-58	R02
Formica Graystone	464-58	R02
Formica Folkstone	927-58	R03
Formica Graphite	837-58	R05

### Patterned Laminates

Nevamar Cool Chic	VA7002T	R02
Nevamar Serene Stardom	VA5001T	R05
Nevamar Calm Distinction	VA6001T	R05
Nevamar Easy Elegance	VA5002T	R05
Wilsonart Sheer Mesh	4876-38	R02
Wilsonart Grey Mesh	4877-38	R02
Wilsonart Pewter Mesh	4878-38	R05

## ABS FINISHES

Ashen	R04
Parchment	R02
Shale	R05
Stone	R03
Whitecap	R01