

# TWO4SIX<sup>®</sup>

## Planning Guide + Price List

---

### QUICK LINKS

[PLANNING GUIDE](#)

[MEETING TABLES](#)

[MEDIA TABLES](#)

[STANDING HEIGHT  
MEETING TABLES](#)

[HEIGHT ADJUSTABLE  
MEETING TABLES](#)

[POWER AND DATA OPTIONS](#)

[GENERAL INFORMATION](#)

[FINISH INFORMATION](#)

[SURFACE MATERIALS](#)



# TABLE OF CONTENTS

Click the shortcuts below to jump to each section.

General Information	ii-iii
Finish Information	iv-v
Surface Materials	vi-viii
Statement of Line	3
Specification Overview	4
<b>MEETING TABLES</b>	
Round / Square / Soft Square Tops	49-55
Rectangle / Soft Rectangle Tops	56-73
<b>MEDIA TABLES</b>	
60" Credenza Base	74-80
72" Credenza Base	80-85
Wall-Mounted - Slab Base	86-103
<b>STANDING HEIGHT MEETING TABLES</b>	
Rectangle / Soft Rectangle Tops	104-121
<b>HEIGHT ADJUSTABLE MEETING TABLES</b>	122
<b>POWER AND DATA OPTIONS</b>	123-133
<b>ACCESSORIES</b>	134-135

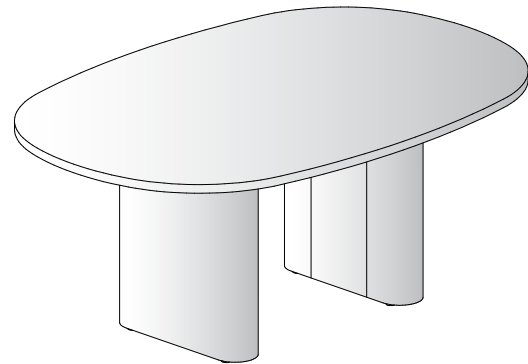
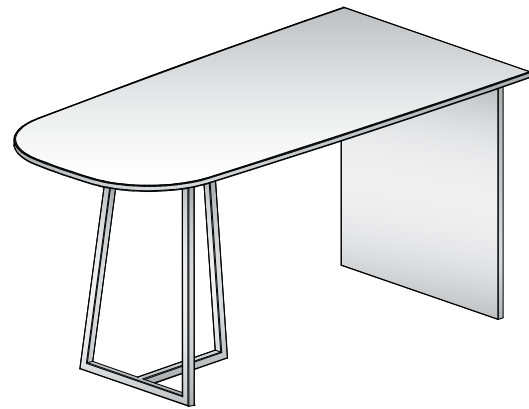
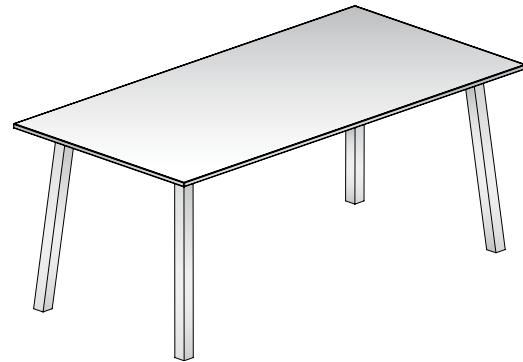



# STATEMENT OF LINE

## MEETING TABLES

Pages 49-73



Round



Square

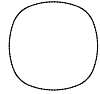

Soft Square



Rectangle

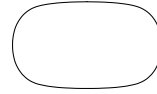

Soft Rectangle

## RECTANGLE AND SOFT RECTANGLE BASES

Pages 56-73

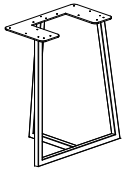

Open Frame

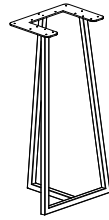

Open Frame Standing



Post Leg

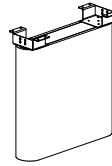

Racetrack Base

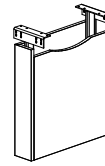

Rectangle Center Base

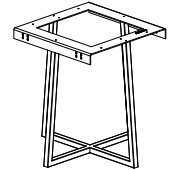

X Center Base

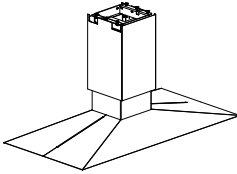

Adjustable Height Base

## ROUND, SQUARE AND SOFT SQUARE BASES

Page 49-55

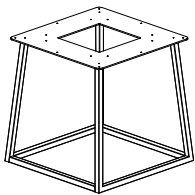

Open Frame Square



Post Leg

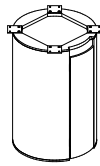

Cylinder Base



# STATEMENT OF LINE

## MEDIA TABLES

---

Pages 74-103



D-Shape

## WALL-MOUNTED BASES

---

Pages 74-103

### FLAT END OF TABLE

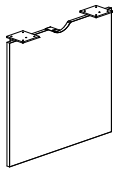

Slab

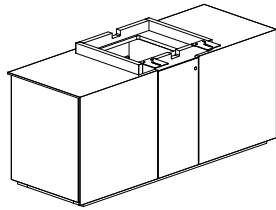

Credenza

### RADIUS END OF TABLE

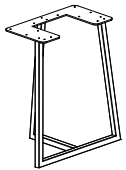

Open Frame Seated

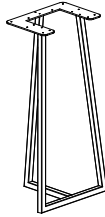

Open Frame Standing



Post Leg

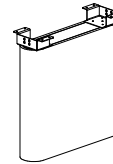

Racetrack Base



# STATEMENT OF LINE

## CADDY

---

Page 134

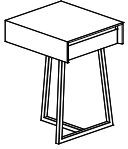

## CONSOLE

---

Page 135

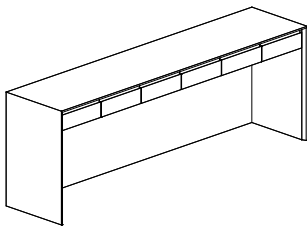



# SPECIFICATION OVERVIEW

---

## 1. Select the Table Type

Options include Meeting Tables, Standing Height Meeting Tables, Height Adjustable Meeting Tables, and Wall-mounted Media Tables.

## 2. Select the Top Surface Material

Choose between standard veneer with hardwood edge, inset laminate with hardwood edge, laminate with cutback ABS edge, laminate with square ABS edge, glass, solid surface or stone/quartz.

## 3. Select the Top Size and Shape

Two4Six tables are available in round, square, soft square, rectangle, soft rectangle, and D-shape. Sizes range from 30"- to 72"-wide and from 48"- to 240"-long.

## 4. Select the Base Style and Finish

Two4Six tables are available with Metal Post Legs, Open Frame, and Racetrack base styles, as well as a Height Adjustable base option. Metal Post Leg and Open Frame bases are offered with powder coated paint or polished chrome finishes. In addition, the Metal Post Leg is available with a clear anodized finish. The Racetrack base is offered in laminate, painted, or veneer. Media Tables include a Slab base (available in both painted and veneered surfaces) or a Credenza base (available in veneer only). Height adjustable Racetrack base also offered on Media Table.

## 5. Select the Power/AV Option (if desired)

Options for power and AV connectivity include:

- Table Top: Tech Node, Power Cap or Power Matrix (Small or Medium)
- Sub-Top: Power Rail



# MEETING TABLES

Meeting tables are offered in round, square, soft square, rectangle and soft rectangle shapes at a seated height (29.5"). A standing height (42") option is also available for rectangle and soft rectangle tables. Meeting table base options include 2"-square Metal Post Legs, an Open Frame base (made from 1.25" square metal tube), Racetrack base, and Cylinder base (for round tables only).

BASE MATERIAL OPTIONS						
	VENEER	PAINTED	LAMINATE	POWDER COAT	POLISHED CHROME	CLEAR ANODIZED
Racetrack	X	X	X			
2" Post Metal Leg				X	X	X
Open Frame				X	X	
Adjustable Height (Meeting Table)				X		

**TABLES 156" & LONGER**

Rectangle Center	X	X				
X Center				X	X	

**MEDIA TABLES ONLY**

Wall-mounted Slab	X	X				
Credenza	X					
Rectangle Base	X	X	X			

**ROUND TABLES ONLY**

Cylinder	X	X				
----------	---	---	--	--	--	--

**TOP MATERIAL OPTIONS**

	VENEER	LAMINATE (ALL EDGES)	GLASS	SOLID SURFACE	STONE
Round, Square & Soft Square	X	X	X	X	X
Rectangle & Soft Rectangle	X	X	X	X	
D-Shape	X	X	X	X	

**Soft Rectangle Meeting Table with Open Frame Base**

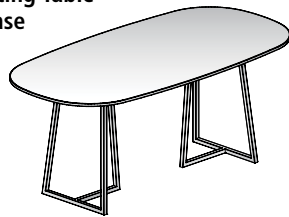

**Rectangle Meeting Table with Metal Post Legs and Rectangle Center Base**

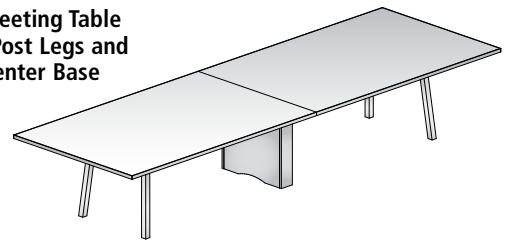

**Rectangle Meeting Table with Metal Post Legs**

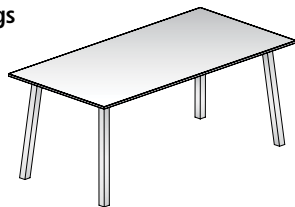

**Rectangle Meeting Table with Open Frame Base and X Center Base**

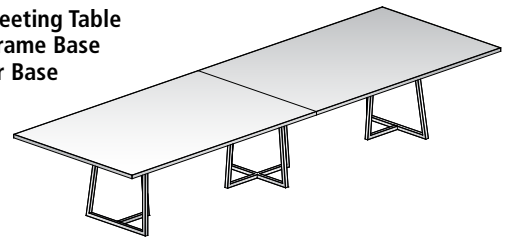

**Soft Rectangle Meeting Table with Racetrack Base**

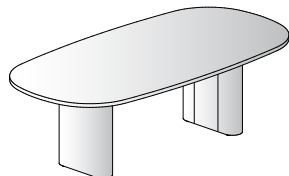

**Rectangle Meeting Table with Racetrack Base**

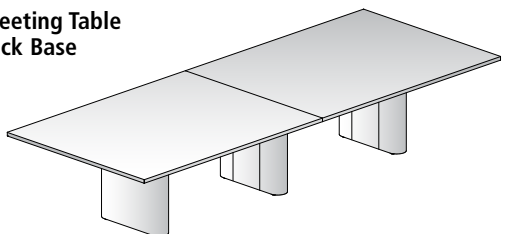



## WALL-MOUNTED MEDIA TABLES

There are two options for Media Tables: wall-mounted and freestanding. Both styles are available with a variety of base options.

Wall-mounted media tables are available in seated, counter and standing heights and require an architectural wall on which to be mounted.

The flat end of the table offers a Slab base available in seated, counter and standing heights. Credenza base is available in seated height and has two case sizes, 60" and 72". In addition, credenza base offers optional pullout waste/recycle bins, equipment rack available on 72", and video conferencing shelf.

On the radius end of the table, options include, 2"- square Metal Post Legs available in seated height, Open Frame base available in seated, counter and standing height or a Racetrack base available in seated and standing heights.

Wall mounted media tables offer optional Monitor Panel. Please see pricing section for more detail.

Please see finish matrix for finishing information on page 7.

### D-Shape Wall-mounted Media Table with Open Frame Base and Slab Base

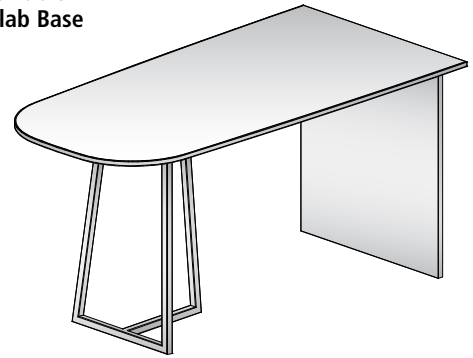

### D-Shape Wall-mounted Media Table with Racetrack Base and Slab Base

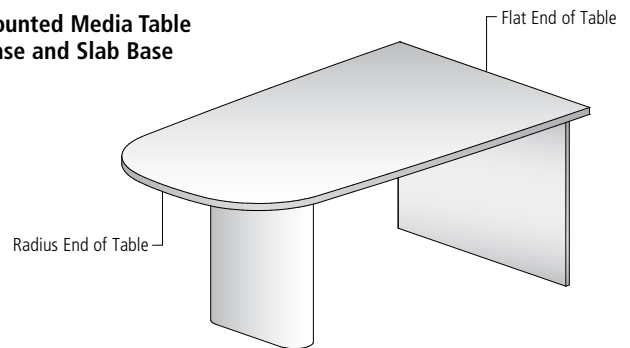

### D-Shape Media Table with Credenza Base

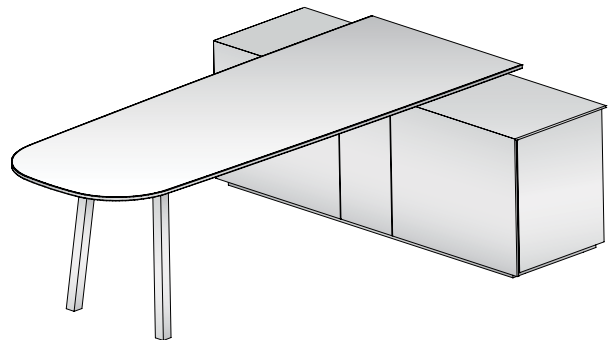

#### Optional Pull-Out Waste/Recycle Bins

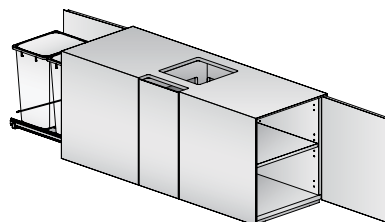

#### Optional Pull-Out Equipment Rack

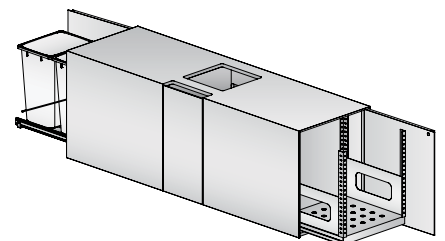





# CADDY

## CADDY

This small but hard-working piece is designed for all those little items typically found in a conference room (markers, erasers, pens, Post-It notes, phone lists, etc.), but for which there is often not a home. It features a storage box on top of an Open Frame base. The front features a drawer with integrated pull. The box is available with either a veneer or painted finish.

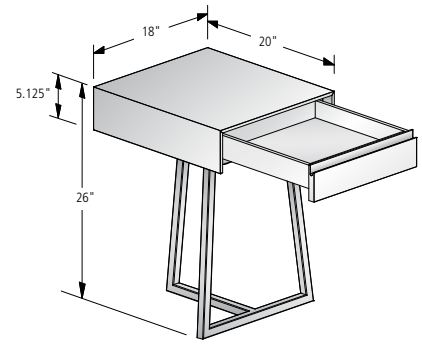
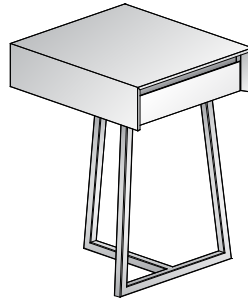



# ADJUSTABLE HEIGHT TABLE

The adjustable height table promotes wellness and can be used to imply meeting duration or encourage impromptu collaboration. Offering a height adjustment range from 28" to 42".

## ADJUSTABLE HEIGHT TABLE

This rectangular desk features a metal column base.

- Adjustment range is from 28" to 42"
- Controller features digital height readout and four programmable stops
- Features a metal column base
- Available with Power Rail

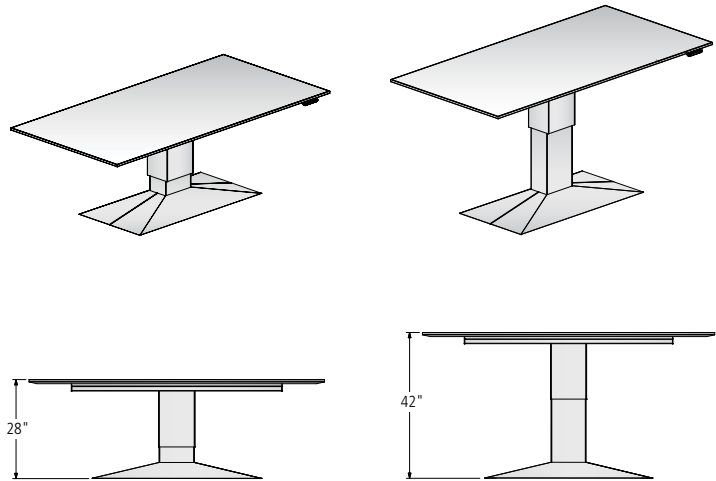

## Wire Management for Adjustable Height Table

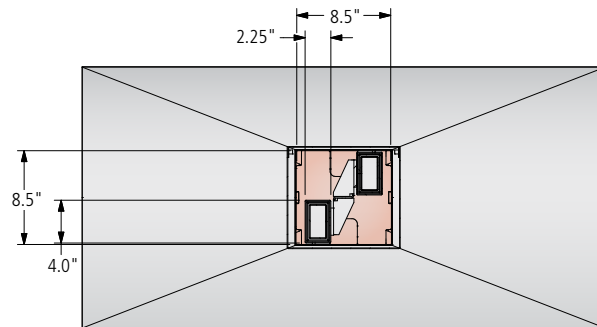

## PROGRAMMABLE CONTROLLER

The programmable controller features up/down buttons, four programmable preset stops, and a digital readout that displays the worksurface height.

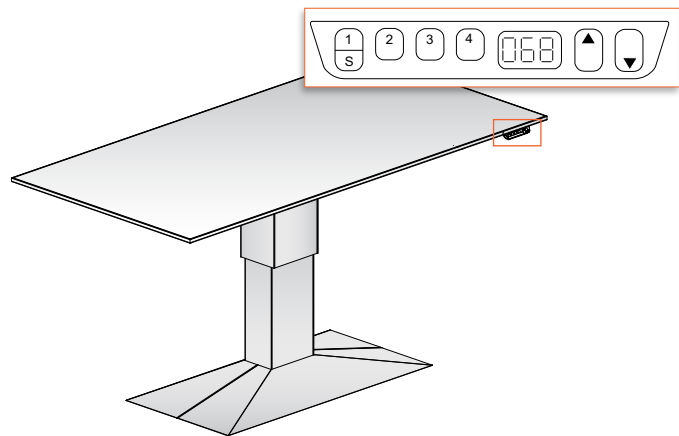



## TABLE TOP POWER OPTION: POWER MATRIX

Available in a variety of sizes, styles and connectivity options, Power Matrix is Nucraft's most versatile power option. Power Matrix incorporates a broad array of scalable features and is available across multiple product lines, making it the "go to" solution for power and AV connectivity needs.

Offered in a Small and Medium size, Power Matrix can handle any power and AV connectivity need, from the simplest to the most demanding.

### Small

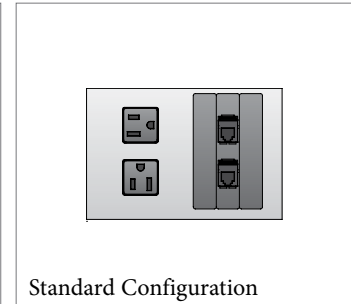
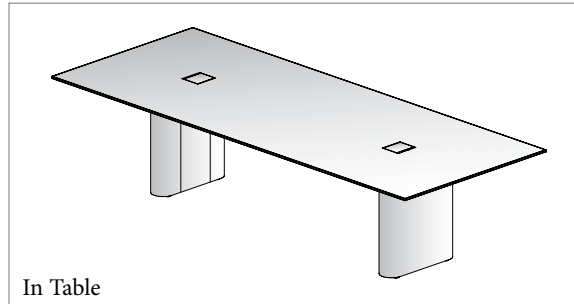

### Medium

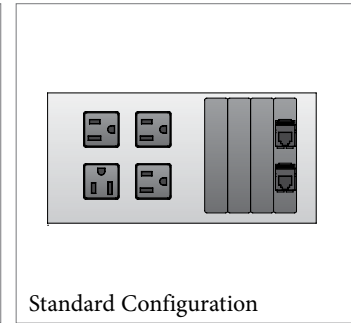
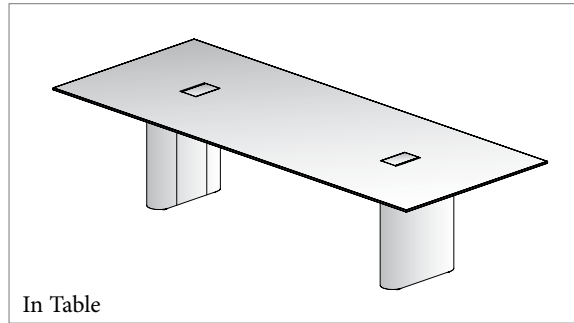
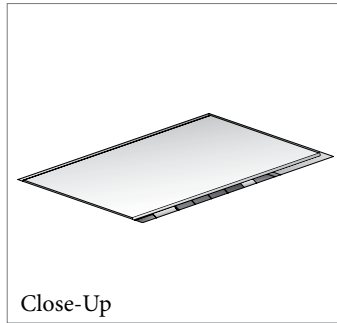

## TABLE TOP POWER OPTION: POWER MATRIX

Power Matrix is filled with a broad array of high performance features and refined aesthetic elements.

### POWER

Power Matrix features simplex receptacles for power connectivity, the quantity of which is pre-determined based on the size of the unit. An optional USB-A+C charger can also be specified in place of one of the simplex receptacles when desired. Corded or hardwired infeed options add flexibility.

### DATA/AV FACEPLATES

Power Matrix accommodates Extron Architectural Adaptor Plates (AAPs) for unparalleled flexibility in data and AV connectivity.

### DESIGN

Power Matrix units feature a clear anodized aluminum body and a bezel-free flush mount design on wood tables for an elegant appearance. Laminate, glass or stone/quartz table tops include a bezel, available in powder coat, polished chrome or clear anodized finish options.

### PERFORMANCE

Friction hinges ensure smooth travel through the door's range of motion and can hold the door in any position. Hidden door stops maintain the minimalist aesthetic. Cable storage is both concealed and ample.

### DOORS

Power Matrix is offered in multiple door material options, including metal, glass and grain-matched wood cut from the same table top.

### FIELD-WIRED

Some local electrical codes may require field-wiring during installation. In such instances, a Field-Wired option may be specified. In this configuration, each Power Matrix unit will be supplied with a 6' flexible metal conduit with hot, ground and neutral wires.

(Medium size shown)

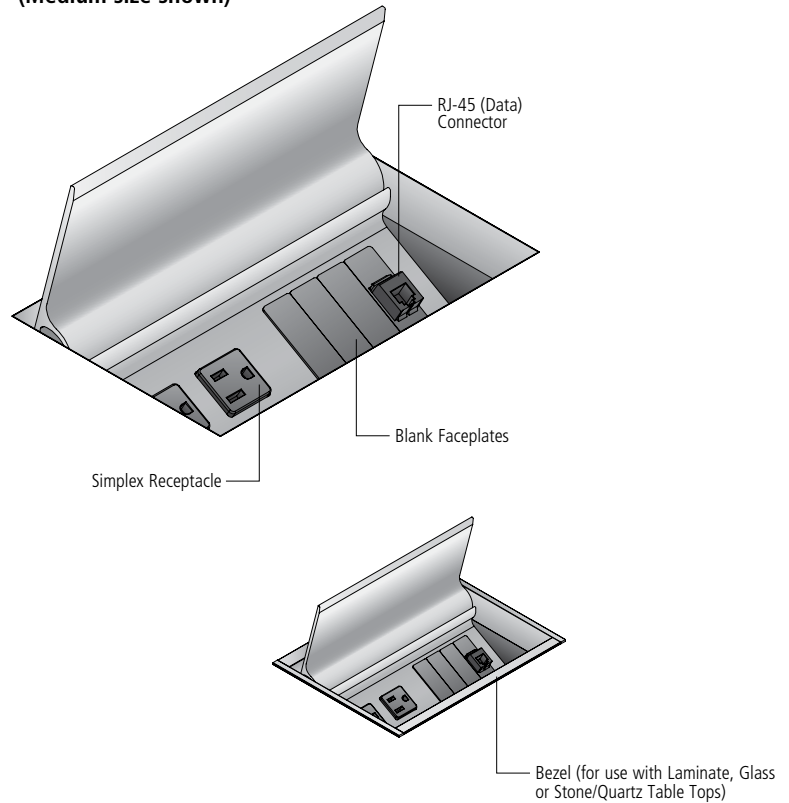



# TABLE TOP POWER OPTION: POWER MATRIX

## STANDARD CONFIGURATIONS

Power Matrix is available in two sizes for Two4Six, each with a pre-determined quantity of simplex outlets and AV faceplates. With each size, an optional 2 amp USB-A+C charger (1 amp per port) replaces one of the simplex outlets.

### Small

- Single door design
- 5.375" x 6" cutout
- Two simplex outlets
- Three AV faceplates. Standard configuration includes two blank faceplates & one faceplate with two RJ-45 (data) connectors.

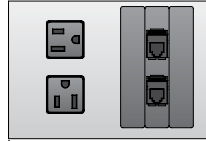

### Medium

- Single door design
- 5.375" x 8.25" cutout
- Four simplex outlets
- Four AV faceplates. Standard configuration includes three blank faceplates & one faceplate with two RJ-45 (data) connectors.

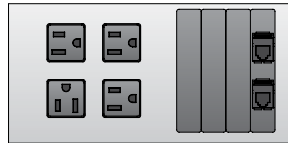

## DIMENSIONS

Each Power Matrix unit includes a low-profile pan beneath the work surface to conceal the unit and provide ample storage capacity for excess cables. The size of the cutout in the table top varies with each size of Power Matrix unit.

### Small

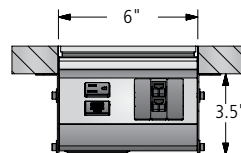
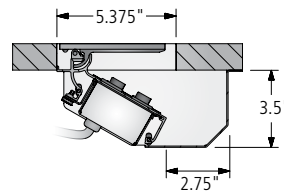

### Medium

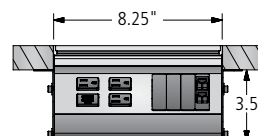
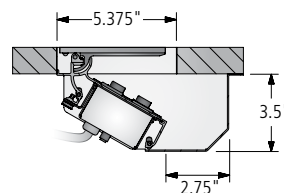

# TABLE TOP POWER OPTION: POWER MATRIX

## POWER PLANNING

Power Matrix is available with two options for connection with building power:

### DIRECT PLUG-IN

The 15-amp power cord from each Power Matrix unit is plugged into a floor monument. The floor monument must have at least one power outlet per small or medium Power Matrix unit in the table (e.g., a table with four small or medium Power Matrix units would need four power outlets in the floor monument).

**Direct Plug-In**

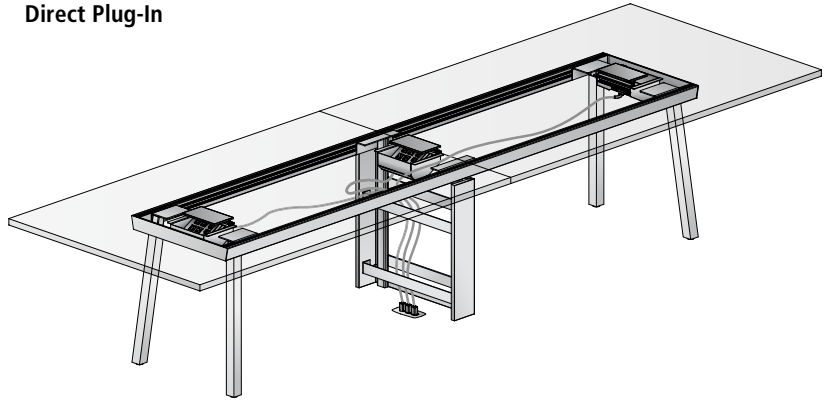

### SINGLE INFEED

Each Power Matrix unit is plugged into a two-circuit modular electrical system in the table from which a single connection is made to a floor monument. This connection can be either hardwired (to utilize both of the circuits in the modular electrical system) or corded (which requires a 20-amp power outlet in the floor monument and reduces the modular electrical system in the table to a single circuit).

**Single Infeed**

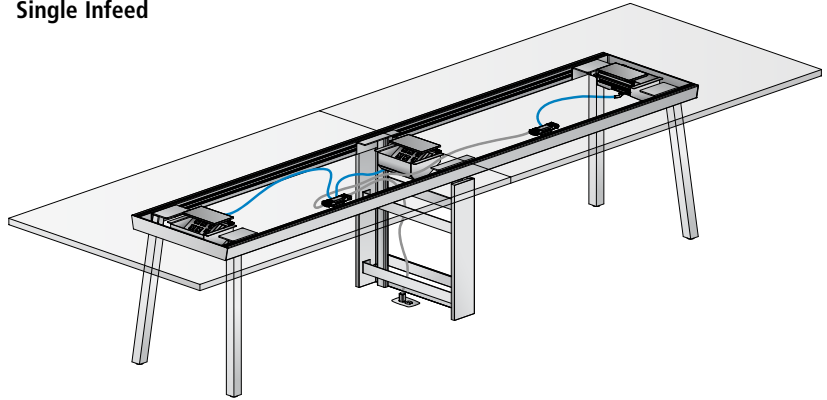

### Two-Circuit Modular Electrical System

- 4-wire, 20-amp, 2-circuit modular electrical system
- Only present on tables specified with the Single In-Feed option
- Hardwire or corded (20-amp) in-feed options. A licensed electrician is required to complete hardwire connections to building's power source.
- Neutral (white) wires are 10 gauge, hot and ground wires are 12 gauge
- All electrical components satisfy National Electrical Code (NEC) requirements and are UL listed

### Electrical Diagram — Hardwire Power Infeed Only

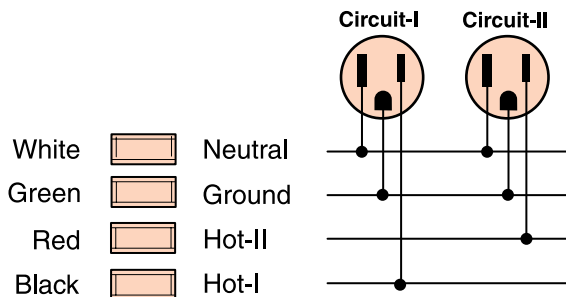



# TABLE TOP POWER OPTION: POWER MATRIX

## LOCATION CODES

Power Matrix is offered in a variety of locations and quantities per table size, offering a broad range of performance and pricing options.

POWER MATRIX SMALL	POWER MATRIX MEDIUM	LOCATION	QUANTITY OF UNITS TO ORDER
PS-1	PM-1	One at center	1
PS-1W	PM-1W	One at wall end (Media Table only)	1
PS-2*	PM-2*	One at each end	2
PS-3*	PM-3*	One at center and one at each end	3
PS-4*	PM-4*	Four equally spaced	4

\*Not offered on Media Tables, Standing Height Tables, or Counter Height Tables

## DOOR MATERIAL AND LOCATION AVAILABILITY BY TABLE SIZE

W = Wood Door    G = Glass Door    M = Metal Door

Length	Top Sections	Power Matrix Small					Power Matrix Medium				
		PS-1	PS-1W <sup>†</sup>	PS-2*	PS-3*	PS-4*	PM-1	PM-1W <sup>†</sup>	PM-2*	PM-3*	PM-4*
48	1	W/G/M	-	-	-	-	-	-	-	-	-
54	1	W/G/M	-	-	-	-	-	-	-	-	-
60	1	W/G/M	W/G/M	-	-	-	-	W/G/M	-	-	-
66	1	W/G/M	W/G/M	-	-	-	W/G/M	W/G/M	-	-	-
72	1	W/G/M	W/G/M	-	-	-	W/G/M	W/G/M	-	-	-
84	1	W/G/M	W/G/M	-	-	-	W/G/M	W/G/M	-	-	-
90	1	W/G/M	W/G/M	-	-	-	W/G/M	W/G/M	-	-	-
96	1	W/G/M	W/G/M	-	-	-	W/G/M	W/G/M	-	-	-
102	1	W/G/M	-	W/G/M	W/G/M	-	W/G/M	-	W/G/M	W/G/M	-
102	2	-	-	W/G/M	-	-	-	-	W/G/M	-	-
108	1	W/G/M	-	W/G/M	W/G/M	-	W/G/M	-	W/G/M	W/G/M	-
108	2	-	-	W/G/M	-	-	-	-	W/G/M	-	-
114	1	W/G/M	-	W/G/M	W/G/M	-	W/G/M	-	W/G/M	W/G/M	-
114	2	-	-	W/G/M	-	-	-	-	W/G/M	-	-
120	1	W/G/M	-	W/G/M	W/G/M	-	W/G/M	-	W/G/M	W/G/M	-
120	2	-	-	W/G/M	-	-	-	-	W/G/M	-	-
132	2	-	-	W/G/M	-	W/G/M	-	-	W/G/M	-	W/G/M
144	2	-	-	W/G/M	-	W/G/M	-	-	W/G/M	-	W/G/M
156	2	-	-	W/G/M	-	W/G/M	-	-	W/G/M	-	W/G/M
168	2	-	-	W/G/M	-	W/G/M	-	-	W/G/M	-	W/G/M
180	2	-	-	W/G/M	-	W/G/M	-	-	W/G/M	-	W/G/M
192	2	-	-	W/G/M	-	W/G/M	-	-	W/G/M	-	W/G/M
192	4	-	-	W/G/M	-	W/G/M	-	-	W/G/M	-	W/G/M
204	2	-	-	W/G/M	-	W/G/M	-	-	W/G/M	-	W/G/M
204	4	-	-	W/G/M	-	W/G/M	-	-	W/G/M	-	W/G/M
216	2	-	-	W/G/M	-	W/G/M	-	-	W/G/M	-	W/G/M
216	4	-	-	W/G/M	-	W/G/M	-	-	W/G/M	-	W/G/M
228	2	-	-	W/G/M	-	W/G/M	-	-	W/G/M	-	W/G/M
228	4	-	-	W/G/M	-	W/G/M	-	-	W/G/M	-	W/G/M
240	2	-	-	W/G/M	-	W/G/M	-	-	W/G/M	-	W/G/M
240	4	-	-	W/G/M	-	W/G/M	-	-	W/G/M	-	W/G/M

<sup>†</sup>Available on Media Tables only

\*Not offered on Media Tables, Standing Height Tables, or Counter Height Tables



# TABLE TOP POWER OPTION: POWER MATRIX

## POWER MATRIX SMALL OR MEDIUM LOCATION OPTIONS

Please Note: For floor core placement, please reference base location information on pages 41-48.

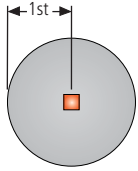

PS-1 or PM-1

PS-1 or PM-1	
Diameter	Center of Power Matrix
48	24
54	27
60	30

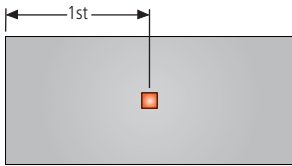

PS-1 or PM-1

PS-1 or PM-1	
Length	Center of Power Matrix
60	30
66	33
72	36
84	42
90	45
96	48
102	51
108	54
114	57
120	60

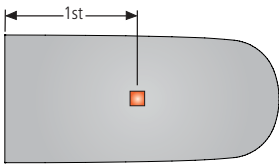

PS-1 or PM-1

PS-1 or PM-1	
Length	Center of Power Matrix
60	30
66	33
72	36
78	39
84	42
90	45
96	48

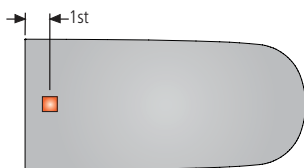

PS-1W or PM-1W\*

\*Available on Media Tables only

PS-1W or PM-1W*	
Length	Center of Power Matrix
60	7.5
66	7.5
72	7.5
78	7.5
84	7.5
90	7.5
96	7.5





# TABLE TOP POWER OPTION: POWER MATRIX

## POWER MATRIX SMALL OR MEDIUM LOCATION OPTIONS

Please Note: For floor core placement, please reference base location information on pages 41-48.

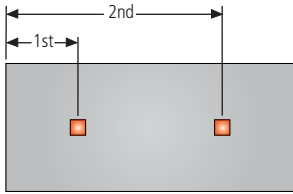

PS-2 or PM-2\*

\*Not offered on Media Tables, Standing Height Tables, or Counter Height Tables

PS-2 or PM-2*		
Length	Center of 1st Power Matrix	Center of 2nd Power Matrix
102	26	76
108	26	82
114	26	88
120	26	94
132	26	106
144	26	118
156	26	130
168	26	142
180	26	154
192	26	166
204	26	178
216	26	190
228	26	202
240	26	214

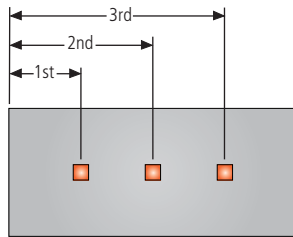

PS-3 or PM-3\*

\*Not offered on Media Tables, Standing Height Tables, or Counter Height Tables

PS-3 or PM-3*			
Length	Center of 1st Power Matrix	Center of 2nd Power Matrix	Center of 3rd Power Matrix
102	26	51	76
108	26	54	82
114	26	57	88
120	26	60	94

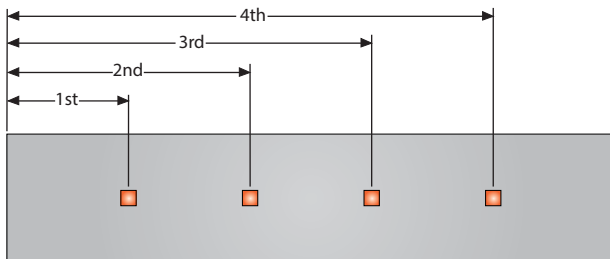

PS-4 or PM-4\*

\*Not offered on Media Tables, Standing Height Tables, or Counter Height Tables

PS-4 or PM-4*				
Length	Center of 1st Power Matrix	Center of 2nd Power Matrix	Center of 3rd Power Matrix	Center of 4th Power Matrix
132	26	53	79	106
144	26	57	87	118
156	26	61	95	130
168	26	65	103	142
180	26	69	111	154
192	26	73	119	166
204	26	77	127	178
216	26	81	135	190
228	26	85	143	202
240	26	89	151	214



# RETRACTORS FOR POWER MATRIX

## RETRACTORS

Cable retractors, for use with Power Matrix Small and Medium only, mount directly to the underside of conference room tables using the included mounting bracket. Loaded with 12' of cable that extends out 5' from the retractor. Retractors have a female input from the building infrastructure and a male connector on the output side. Not available on square, round or soft square tables.

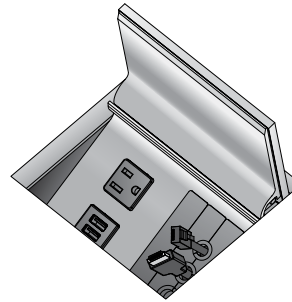

### RETRACTOR AVAILABILITY ON TWO4SIX TABLES X = AVAILABLE AS STANDARD

Length	PS-1/ PM-1	PS-2/ PM-2	PS-3/ PM-3	PS-4/ PM-4
72	X			
78	X			
84	X			
90	X			
96	X			
102	X	X		
108	X	X		
114	X	X	X	
120	X	X	X	
132		X		
144		X		X
156		X		X
168		X		X
180		X		X
192		X		X
204		X		X
216		X		X
228		X		X
240		X		X

### Retractor Wire Management

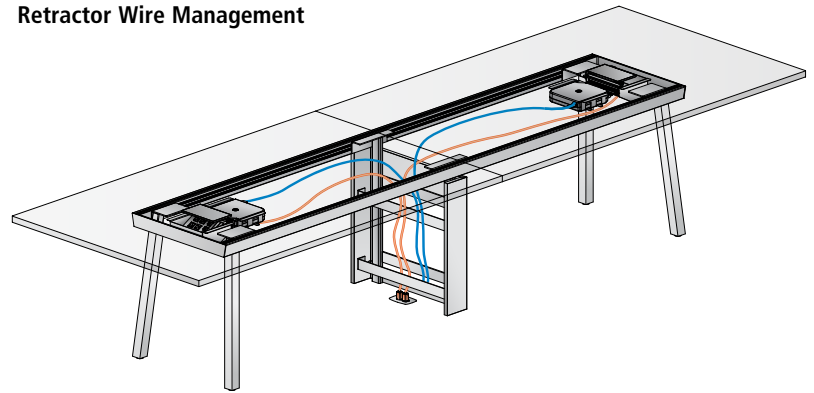

### CAT6 Retractor

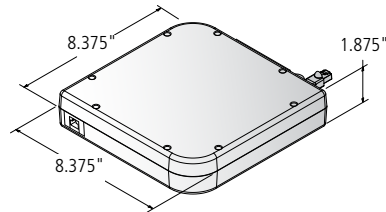

### HDMI Retractor

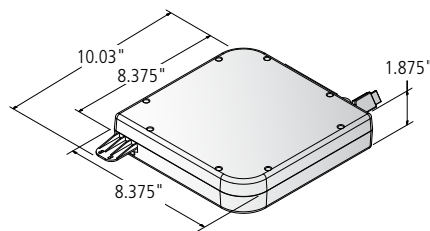

### Data USB Retractor

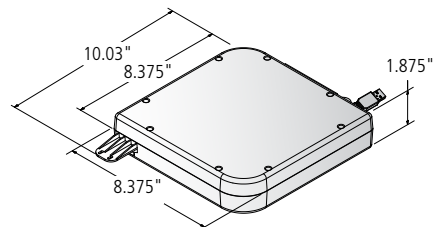



# TABLE TOP POWER OPTION: POWER CAP

## POWER CAP

Power Cap offers low profile yet robust power and data connectivity on the table surface. Power Cap is available in two sizes: Four Port and Two Port.

Four Port Power Cap configuration options:

- Two simplex receptacles and two USB-A+C chargers (Default Configuration)
- One simplex receptacle, one USB-A+C charger, and two blank Extron Architectural Adaptor Plates (AAPs)
- Two simplex receptacles and two blank AAPs

Two Port Power Cap configuration options:

- One simplex receptacle and one USB-A+C charger (Default Configuration)
- Two simplex receptacles

Intended for high use and quick access, Power Cap's low-profile aesthetic is non-lidded for ample space for plug heads of all sizes. The Power Cap metal faceplate is available in powder coat and polished chrome finish.

## DIMENSIONS

- Four Port Power Cap: 2" x 9"
- Two Port Power Cap: 2" x 5.5"
- Power Caps are 3/16" in height

Four Port Power Cap

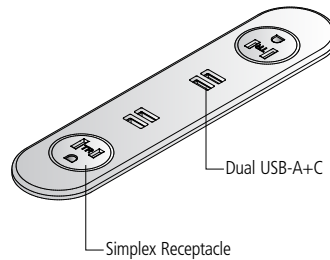

Four Port Default Configuration



Four Port Optional Configurations

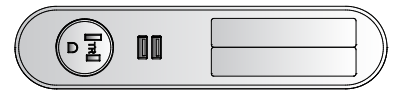
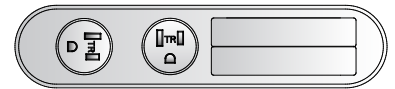

Two Port Power Cap

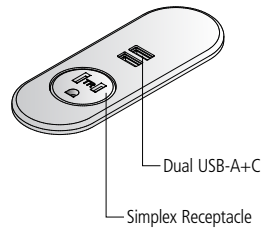

Two Port Default Configuration



Two Port Optional Configuration





# TABLE TOP POWER OPTION: POWER CAP

## POWER CAP FOR ROUND, SQUARE AND SOFT SQUARE TABLES

For round, square and soft square Meeting tables, Power Cap is available in the corresponding shape.

Two Port Power Cap configuration options:

- One simplex receptacle and one USB-A+C charger (Default Configuration)
- Two simplex receptacles

### DIMENSIONS

- Two Port Round Power Cap: 5" x 5"
- Two Port Square Power Cap: 5" x 5"
- Two Port Soft Square Power Cap: 5" x 5"
- Power Caps are 3/16" in height

Two Port Power Cap for Round Tables

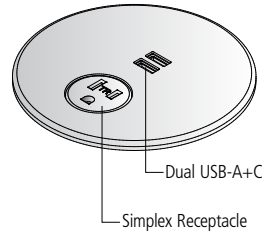

Two Port Round Default Configuration

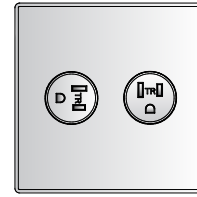

Two Port Round Optional Configuration

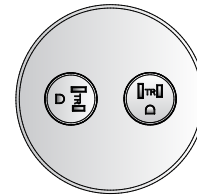

Two Port Power Cap for Square Tables

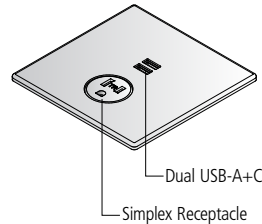

Two Port Square Default Configuration

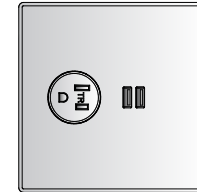

Two Port Square Optional Configuration

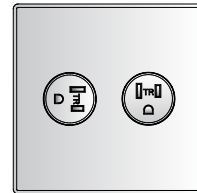

Two Port Power Cap for Soft Square Tables

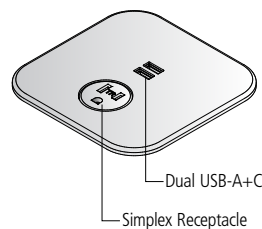

Two Port Soft Square Default Configuration

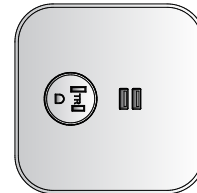

Two Port Soft Square Optional Configuration

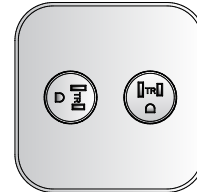



# TABLE TOP POWER OPTION: POWER CAP

## LOCATION CODES

Power Cap is offered in a variety of locations and quantities per table size, offering a broad range of performance and pricing options.

POWER CAP	DESCRIPTION	LOCATION	QUANTITY OF UNITS TO ORDER
CP4-1	Power Cap 4 Port Racetrack Shape	One at Center	1
CP4-1W	Power Cap 4 Port Racetrack Shape (Media Table)	One at End (Media Table Only)	1
CP4-2	Power Cap 4 Port Racetrack Shape	One at Each End	2
CP4-3	Power Cap 4 Port Racetrack Shape	3 Equally Spaced (starting at 96")	3
CP4-4	Power Cap 4 Port Racetrack Shape	4 Equally Spaced (starting at 132")	4
CP2-1	Power Cap 2 Port Racetrack Shape	One at Center	1
CP2-1W	Power Cap 2 Port Racetrack Shape (Media Table)	One at End (Media Table Only)	1
CP2-2	Power Cap 2 Port Racetrack Shape	One at Each End	2
CP2-3	Power Cap 2 Port Racetrack Shape	3 Equally Spaced (starting at 96")	3
CP2-4	Power Cap 2 Port Racetrack Shape	4 Equally Spaced (starting at 132")	4
CPS2-1	Power Cap 2 Port Soft Square Shape (Soft Square Tables only)	One at Center	1
CPR2-1	Power Cap 2 Port Round Shape (Round Tables Only)	One at Center	1
CPQ2-1	Power Cap 2 Port Square Shape (Square Tables Only)	One at Center	1

## POWER CAP LOCATION OPTIONS

Please Note: For floor core placement, please reference base location information on pages 41-48.

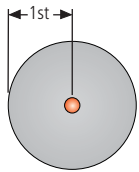

CPS2-1, CPR2-1 or CPQ2-1

### CPS2-1, CPR2-1 or CPQ2-1

Diameter	Center of Power Cap
48	24
54	27
60	30

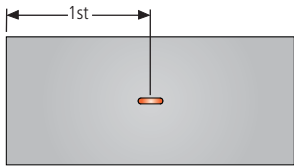

CP4-1 or CP2-1

### CP4-1 or CP2-1

Length	Center of Power Cap
60	30
66	33
72	36
84	42
90	45
96	48
102	51
108	54
114	57
120	60



# TABLE TOP POWER OPTION: POWER CAP

## POWER CAP LOCATION OPTIONS

Please Note: For floor core placement, please reference base location information on pages 41-48.

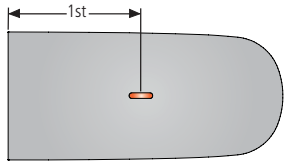

CP4-1 or CP2-1

CP4-1 or CP2-1	
Length	Center of Power Cap
60	30
66	33
72	36
78	39
84	42
90	45
96	48

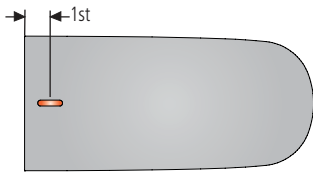

CP4-1W or CP2-1W\*

\*Available on Media Tables only

CP4-1W or CP2-1W*	
Length	Center of Power Cap
60	7.5
66	7.5
72	7.5
78	7.5
84	7.5
90	7.5
96	7.5

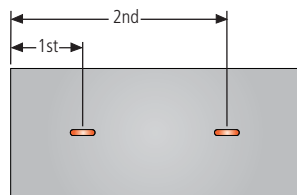

CP4-2 or CP2-2\*

\*Not offered on Media Tables, Standing Height Tables, or Counter Height Tables

CP4-2 or CP2-2*		
Length	Center of 1st Power Cap	Center of 2nd Power Cap
102	26	76
108	26	82
114	26	88
120	26	94
132	26	106
144	26	118
156	26	130
168	26	142
180	26	154
192	26	166
204	26	178
216	26	190
228	26	202
240	26	214



# TABLE TOP POWER OPTION: POWER CAP

## POWER CAP LOCATION OPTIONS

**Please Note:** For floor core placement, please reference base location information on pages 41-48.

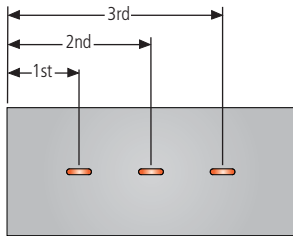

CP4-3 or CP2-3\*

\*Not offered on Media Tables, Standing Height Tables, or Counter Height Tables

CP4-3 or CP2-3*			
Length	Center of 1st Power Cap	Center of 2nd Power Cap	Center of 3rd Power Cap
102	26	51	76
108	26	54	82
114	26	57	88
120	26	60	94

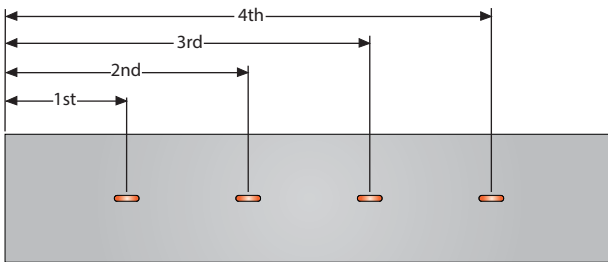

CP4-4 or CP2-4\*

\*Not offered on Media Tables, Standing Height Tables, or Counter Height Tables

CP4-4 or CP2-4*				
Length	Center of 1st Power Cap	Center of 2nd Power Cap	Center of 3rd Power Cap	Center of 4th Power Cap
132	26	53	79	106
144	26	57	87	118
156	26	61	95	130
168	26	65	103	142
180	26	69	111	154
192	26	73	119	166
204	26	77	127	178
216	26	81	135	190
228	26	85	143	202
240	26	89	151	214



# TABLE TOP POWER OPTION: TECH NODE

Tech Node offers convenient access to power and voice/data connections. Tech Node features include a push/push open design that conceals internal components.

Tech Node components:

- Clear or Black Anodized Aluminum
- Fluid one touch accessibility
- Two (2) Simplexes
- Up to two voice/data ports
- 12' 15-Amp cord
- Voice/Data Adapter Kit p/n BE01421 to accept couplers & jacks
- UL Listed
- Overall dimensions - 4-7/16" x 8-5/16"
- Optional powered USB-A+C

All electrical components are UL listed.

Tech Node - Cover Open

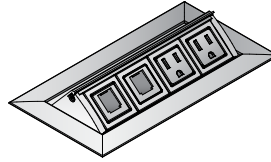

Tech Node - Cover Open with Optional USB-A+C

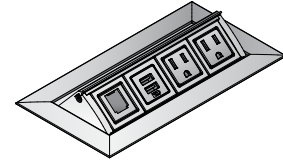

Tech Node - Cover Closed

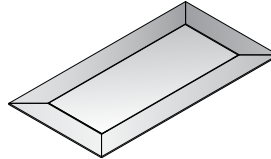

Tech Node - Open Front View

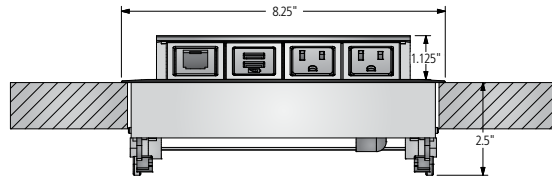

Tech Node - Open Side View

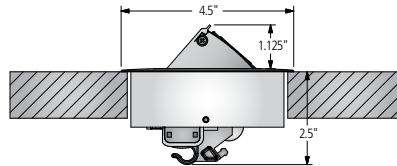

## VOICE/DATA PLANNING

Two (2) simplex voice/data cutouts accept customer supplied, field-installed snap-in connectors.

Nucraft recommends consulting an audio/visual (AV) integrator for assistance with voice/data planning.

## Voice/Data Product Manufacturers

Manufacturer	Phone Number	Web Site
AMP	1-800-522-6752	<a href="http://www.tycoelectronics.com">www.tycoelectronics.com</a>
Avaya	1-866-462-8292	<a href="http://www.avaya.com">www.avaya.com</a>
Leviton	1-800-722-2082	<a href="http://www.leviton.com">www.leviton.com</a>
Panduit	1-800-777-3300	<a href="http://www.panduit.com">www.panduit.com</a>
Siemon	1-860-945-4200	<a href="http://www.siemon.com">www.siemon.com</a>

## LOCATION CODES

TECH NODE	LOCATION	QUANTITY OF UNITS TO ORDER
TN-1	One at center	1
TN-1W	One at wall end (Media Table only)	1
TN-2*	One at each end	2
TN-3*	One at center and one at each end	3
TN-4*	Four equally spaced	4

\*TN-2, TN-3 and TN-4 not offered on Media Tables, Standing Height Tables, or Counter Height Tables





# TABLE TOP POWER OPTION: TECH NODE

## TECH NODE LOCATION OPTIONS

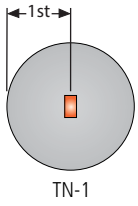

TN-1	
Length	Center of Tech Node
48	24
54	27
60	30
66	33

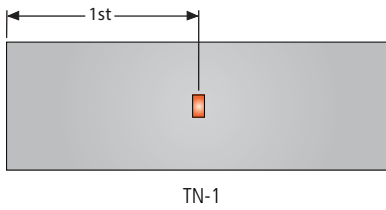

TN-1	
Length	Center of Tech Node
72	36
84	42
90	45
96	48
102	51
108	54
114	57
120	60

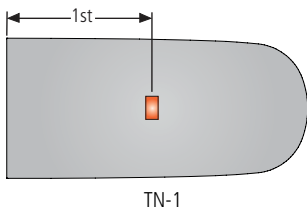

TN-1	
Length	Center of Tech Node
60	30
66	33
72	36
78	39
84	42
90	45
96	48

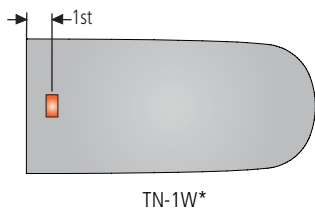

TN-1W*	
Length	Center of Tech Node
60	7.5
66	7.5
72	7.5
78	7.5
84	7.5
90	7.5
96	7.5

\*Available on Media Tables only



# TABLE TOP POWER OPTION: TECH NODE

## TECH NODE LOCATION OPTIONS

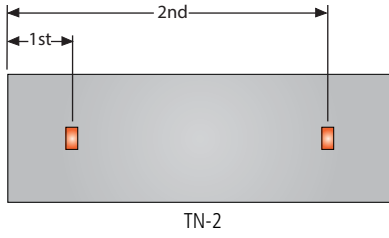

TN-2		
Length	Center of 1st Tech Node	Center of 2nd Tech Node
102	26	76
108	26	82
114	26	88
120	26	94
132	26	106
144	26	118
156	26	130
168	26	142
180	26	154
192	26	166
204	26	178
216	26	190
228	26	202
240	26	214

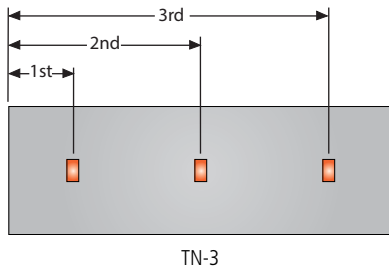

TN-3			
Length	Center of 1st Tech Node	Center of 2nd Tech Node	Center of 3rd Tech Node
102	26	51	76
108	26	54	82
114	26	57	88
120	26	60	94

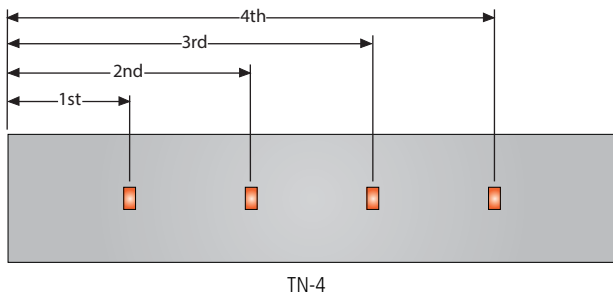

TN-4				
Length	Center of 1st Tech Node	Center of 2nd Tech Node	Center of 3rd Tech Node	Center of 4th Tech Node
132	26	53	79	106
144	26	57	87	118
156	26	61	95	130
168	26	65	103	142
180	26	69	111	154
192	26	73	119	166
204	26	77	127	178
216	26	81	135	190
228	26	85	143	202
240	26	89	151	214



# TABLE TOP POWER OPTION: POWER SPEC AND USB SPEC

## POWER SPEC AND USB SPEC

This compact unit allows for the addition of power or data to a work surface in a discreet way. Available in round or square shapes, and multiple finish options.

### Power Spec

- Spill-proof power simplex
- Compact design
- 1-3/4" cutout for installation
- UL Listed

Power Spec

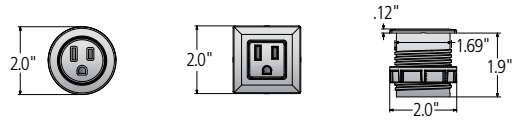

### USB Spec

- Used to charge devices or transfer data
- Compact design
- Offered with USB-A+C
- 1-3/4" cutout for installation
- UL Listed

USB Spec

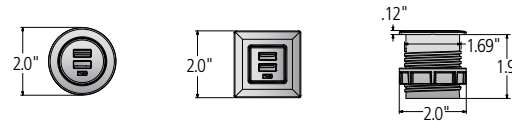



# TABLE TOP POWER OPTION: POWER RAIL

## POWER RAIL

This low-profile option addresses the need for power & data connectivity just below the table top. This is an ideal choice for those who desire a visually uninterrupted table top and appreciate the inherent flexibility of the Power Rail to be removed at a later date as they transition to a truly wireless environment.

Held in place with screws, Power Rail units can be placed anywhere along the perimeter of the table. This flexible mounting design allows for additional units to be added as necessary, or to be removed when no longer needed.

Power Rails are available in three configurations:

- Two simplex receptacles (UL Listed)
- One simplex receptacle and one powered USB-A+C connector (UL Listed)
- Two single space A/V faceplates designed for use with Extron Architectural Adaptor Plates (AAPs)

When Power Rails are specified on a Two4Six table, a direct plug-in infeed or hardwired option is available. The direct plug-in infeed option has a single circuit electrical system and the hardwire option requires a two-circuit electrical system. Maximum of 12 Power Rails per table.

Front Elevation

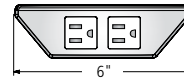

Side Elevation

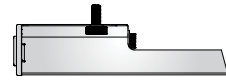
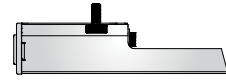
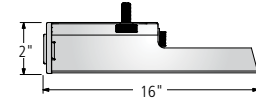



# TABLE TOP POWER OPTION: CHARGING TRAC

## CHARGING TRAC

Charging Trac is a low voltage, under surface power system with 2 USB-A ports per unit. It's modular configuration provides a customizable solution. Offered in a 2 or 4 unit kit of parts with a plug-in infeed. USB-A compatible.

### Charging Trac Wire Management (Flow table with rectangle bases shown)

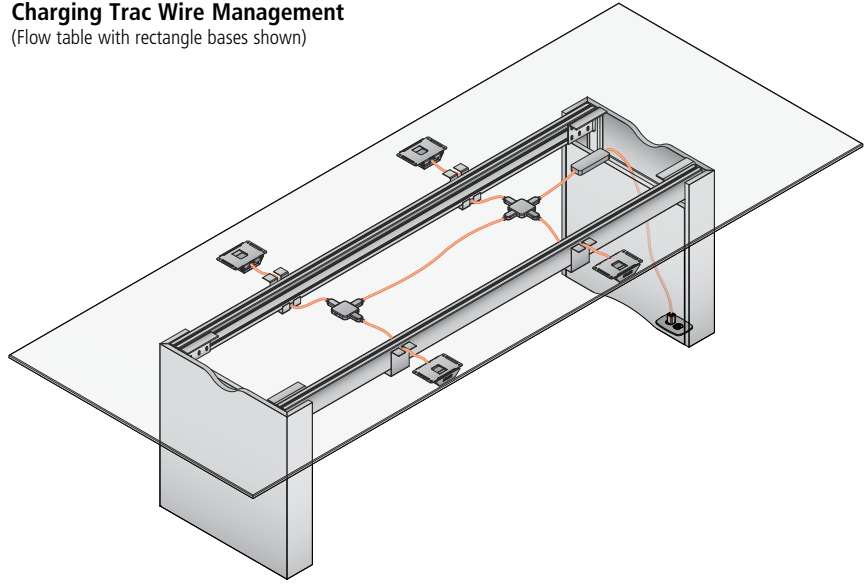

Front Elevation

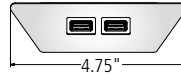

Side Elevation

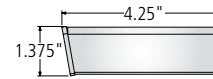

### Two-Unit Configuration includes:

- 2 Brackets, each bracket offers 2 USB-A ports
- 1 Puck
- 1 Plug-in infeed

### Two-Unit Configuration

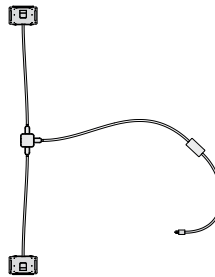

### Four-Unit Configuration includes:

- 4 Brackets, each bracket offers 2 USB-A ports
- 2 Pucks
- Jumpers
- 1 Plug-in infeed

### Four-Unit Configuration

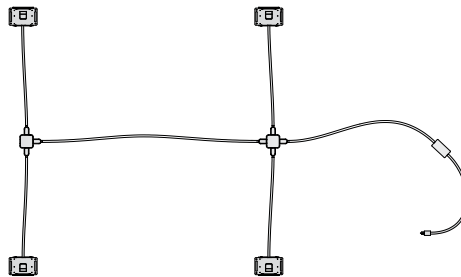



# FREESTANDING POWER OPTION: TECH ZONE

## TECH ZONE

Simple, easy to use and portable, this freestanding table top power option allows you to easily charge all of your devices.

Available in two configurations with a variety of power and data connectivity options. Includes a 72"-long plug-in infeed cord.

### ZONE-USB-C

Includes two simplex receptacles, one data port and one charging USB-A+C charging port

### ZONE-DATA

Includes two simplex receptacles and two open data ports

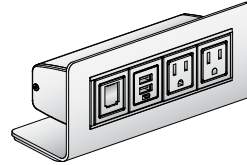

Tech Zone - Side View

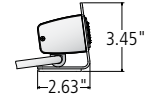

ZONE-USB-C



ZONE-DATA





# POWER PLANNING

## WIRE MANAGEMENT

An aluminum wire management channel, included with each Two4Six table specified with the Post Leg or Open Frame base, can be adhered to the base and can accommodate power and data cables. The wire management channel comes in the same finishes as the Post Leg or Open Frame base.

For more robust needs, a 6"-square Power Pole with metal shrouds, available in any of the powder coat colors, can be specified separately and placed anywhere along the centerline of the table to manage and conceal cables as well as cover a floor monument.

**Wire Management Channel**



**Top View Post Leg with Wire Management Channel**

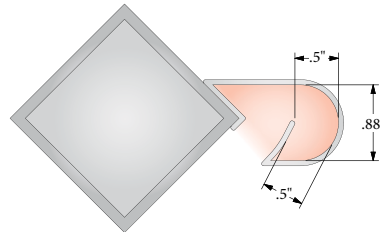

**Power Pole**

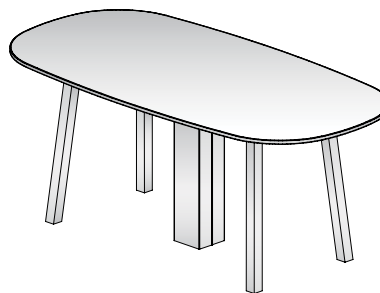



# WIRE MANAGEMENT OPENINGS

## Cylinder Base

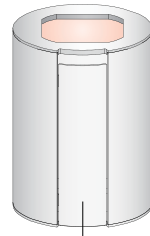

Hinged Access Door  
7.5" W x 24.875" H

18"

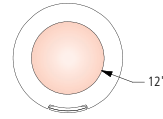

48" Diameter Tops

20"

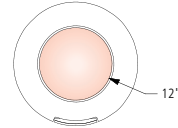

54" Diameter Tops

24"

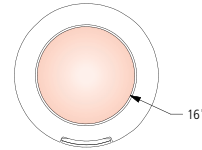

60" Diameter Tops

## Slab Base



Must be anchored  
to a wall, with or  
without Slab Base

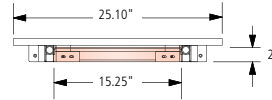

30"-Wide Tops

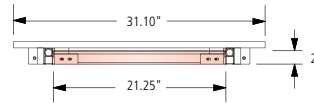

36"-Wide Tops

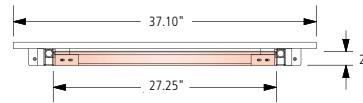

42"-Wide Tops

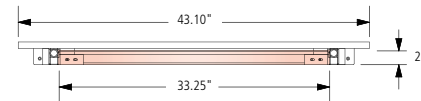

48"-Wide Tops





# WIRE MANAGEMENT OPENINGS

---

**Rectangle Media Table Base**

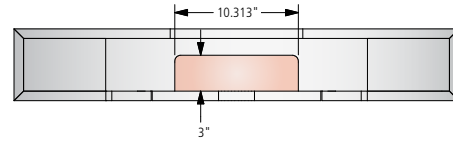
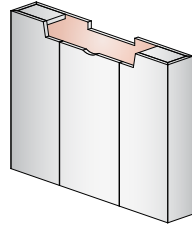



# WIRE MANAGEMENT OPENINGS

## Credenza Base

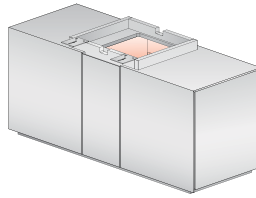

### 60" - Top Panel Cutout

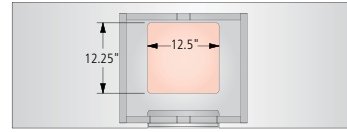

30" - 48"-Wide Tops

### 60" - Back Panel Cutout

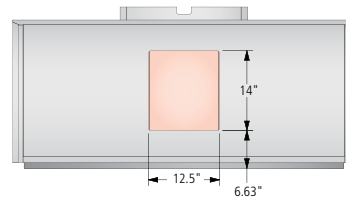

30" - 48"-Wide Tops

### 72" - Top Panel Cutout

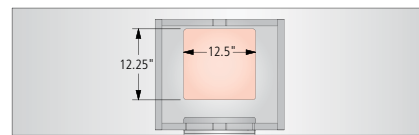

30" - 48"-Wide Tops

### 72" - Back Panel Cutout

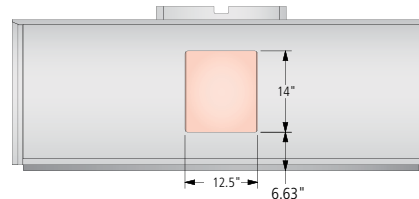

30" - 48"-Wide Tops

## Adjustable Height Base

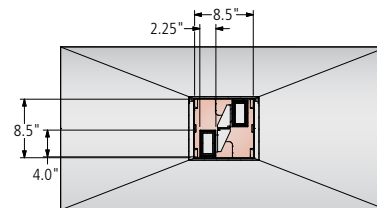



# WIRE MANAGEMENT OPENINGS

## Rectangle Center Base

The Rectangle Center Base has a removable access door, whether or not power has been specified on the table.

For wire management purposes, the access door features a scallop through which cables may pass. When shipped, the scallop is in the top position of the door. The access door may be rotated, however, placing the scallop in the bottom position as shown in the illustration, if needed based on the floor core location.

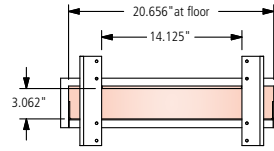
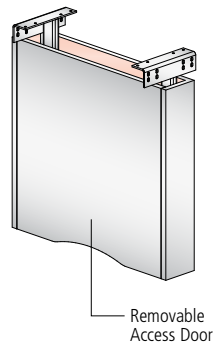

42"-Wide Tops

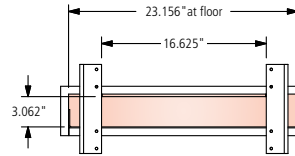

48"-Wide Tops

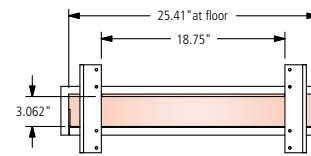

54"-Wide Tops

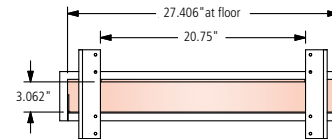

60"-Wide Tops

## Racetrack Base

The Racetrack Base has a removable access door on the inside of the base, whether or not power has been specified on the table.

For wire management purposes, the access door features a scallop through which cables may pass. When shipped, the scallop is in the top position of the door. The access door may be rotated, however, placing the scallop in the bottom position as shown in the illustration, if needed based on the floor core location.

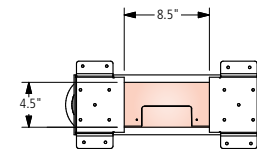
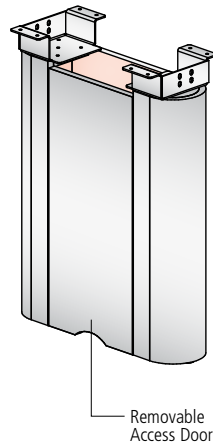

42"-Wide Tops

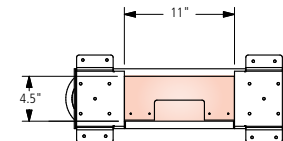

48", 54" & 60"-Wide Tops

For tables that require three bases, the center Racetrack base also has a removable access door, but on only one side of the base.



# WIRE MANAGEMENT OPENINGS

X Center Base

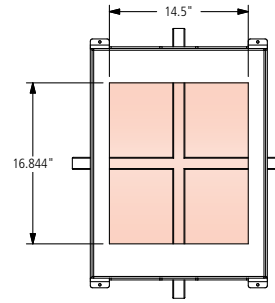
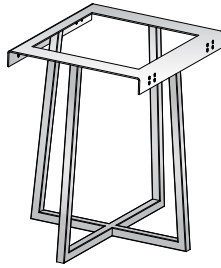

42"-Wide Tops

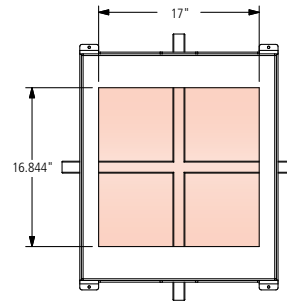

48"-Wide Tops

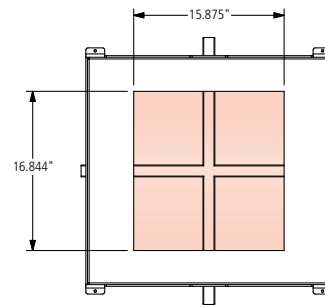

54"-Wide Tops

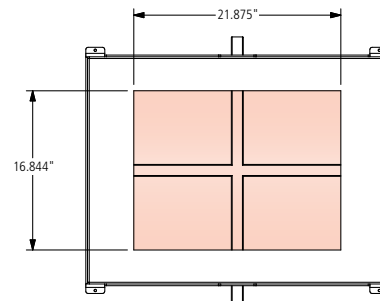

60"-Wide Tops



# BASE DIMENSIONS

## Open Frame Seated Height Base

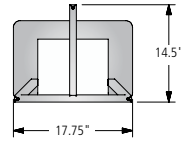
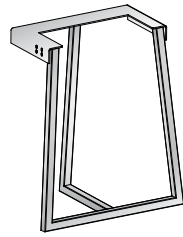

30"-Wide Tops

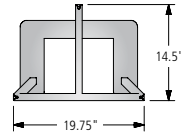

36"-Wide Tops

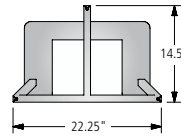
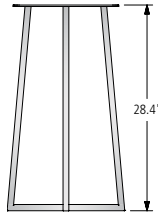

42"-Wide Tops

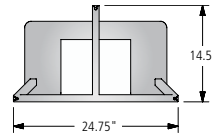

48"-Wide Tops

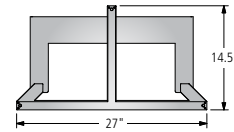

54"-Wide Tops

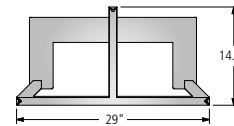

60"-Wide Tops

## Open Frame Standing Height Base (for use with Slab Base)

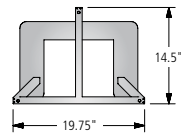
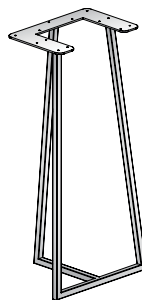

30" - 48"-Wide Tops

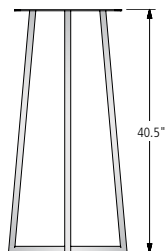



# BASE DIMENSIONS

## Open Frame Square Base

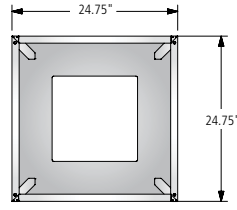
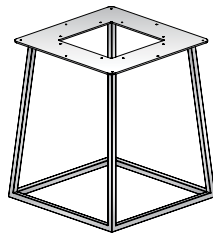

48"-Wide Tops

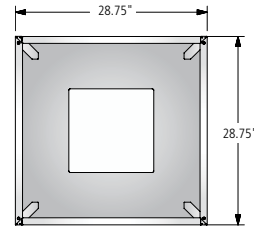
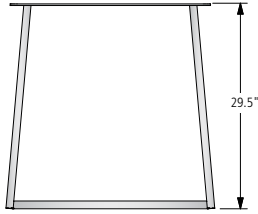

54"-Wide Tops

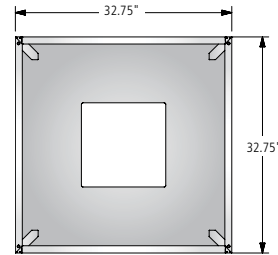

60"-Wide Tops

## Adjustable Height Base

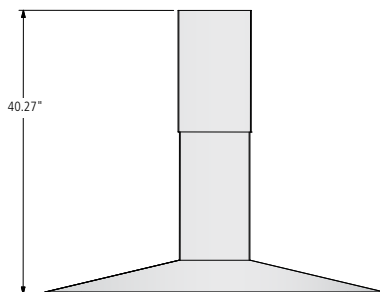
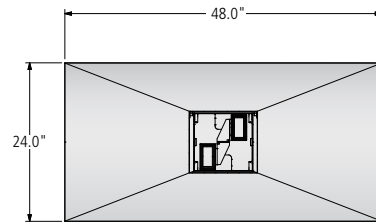
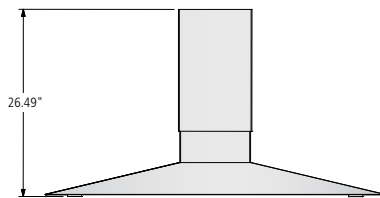

# BASE DIMENSIONS

## Rectangle Center Base

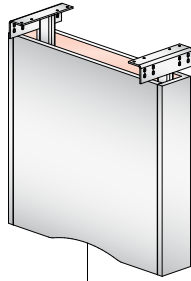

Rectangle Center Base ships with the scallop in the top position. The access door may be rotated, however, placing the scallop in the the bottom position as shown for wire management.

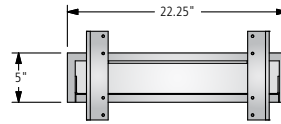

42"-Wide Tops

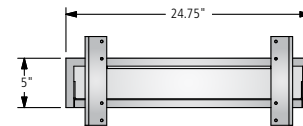

48"-Wide Tops

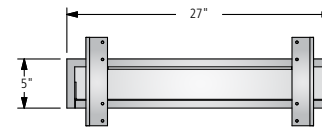

54"-Wide Tops

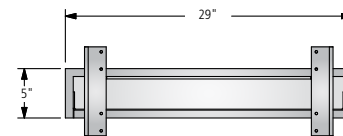

60"-Wide Tops

## Racetrack Base

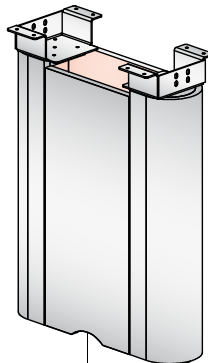

Racetrack Base ships with the scallop in the top position. The access door may be rotated, however, placing the scallop in the the bottom position as shown for wire management.

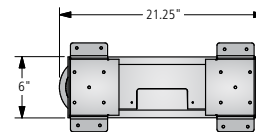

42"-Wide Tops

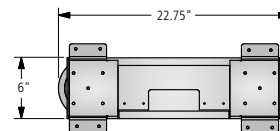

48"-Wide Tops

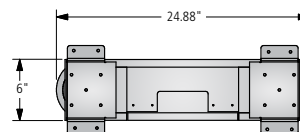

54"-Wide Tops

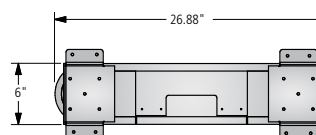

60"-Wide Tops



# BASE DIMENSIONS

X Center Base

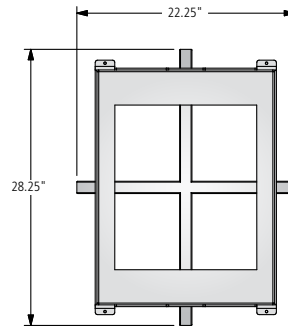
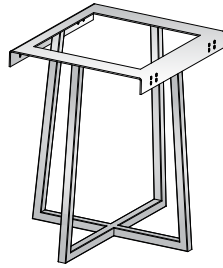

42"-Wide Tops

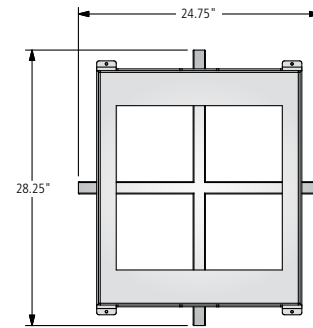

48"-Wide Tops

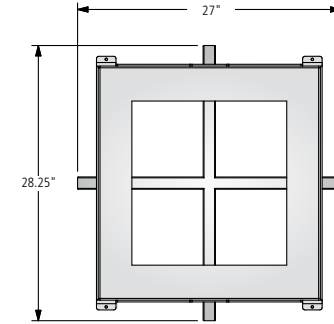

54"-Wide Tops

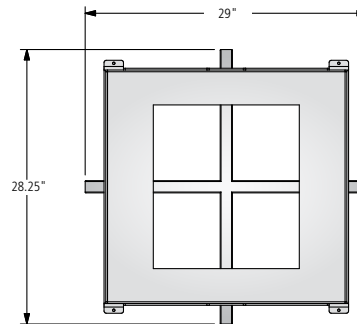

60"-Wide Tops





# BASE LOCATIONS

## ROUND, SQUARE AND SOFT SQUARE TABLES WITH POST LEGS

Two4Six tables in Round, Square, and Rectangle shapes include two leg mounting locations for Post Legs; the standard location (where the bottom of each leg is close to the edge of the table) and an inset position (where the leg is inset slightly for an alternate aesthetic). The inset position on the Rectangle table is ideal if the meeting table is going to be used as a desk. The charts on the following pages indicate the positioning of the Post Legs (in this inset position) as well as the Open Frame bases on Two4Six Meeting tables to assist with floor monument locations.

### Inset Leg Dimensions

(as measured from the edge of the table top to the center of the glide)

#### Round

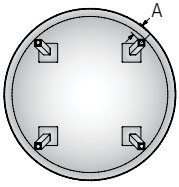

Note: This is the only Post Leg position.

Table Size	Base	A
48"	Post Leg	3.6
54"	Post Leg	3.6
60"	Post Leg	3.6

#### Square

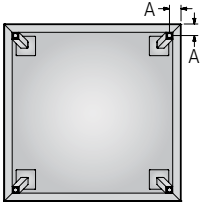

Note: This is the only Post Leg position.

Table Size	Base	A
48"	Post Leg	3.2
54"	Post Leg	3.2
60"	Post Leg	3.2

#### Soft Square

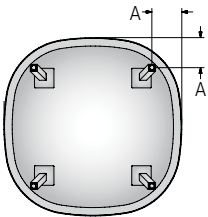

Note: This is the only Post Leg position.

Table Size	Base	A
48"	Post Leg	8.1
54"	Post Leg	8.8
60"	Post Leg	9.5



# BASE LOCATIONS

## ROUND, SQUARE AND SOFT SQUARE TABLES WITH OPEN FRAME SQUARE BASE

### Open Frame Square Base Dimensions

(as measured from the edge of the table top to the center of the glide)

#### Round

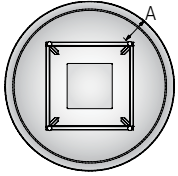

Table Size	Base	A
48"	Open Frame	7.6
54"	Open Frame	7.7
60"	Open Frame	7.9

#### Square

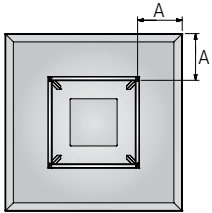

Table Size	Base	A
48"	Open Frame	12.5
54"	Open Frame	13.5
60"	Open Frame	14.5

#### Soft Square

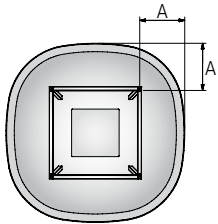

Table Size	Base	A
48"	Open Frame	12.5
54"	Open Frame	13.5
60"	Open Frame	14.5



# BASE LOCATIONS

## RECTANGLE TABLE WITH POST LEGS

Rectangle-shaped tables have two mounting location options for Metal Post Legs: inset, where the legs are mounted inset of the edge of the table, and outset, where the legs are mounted at the corners of the table. The outset option is available on tables from 60" to 96"-long.

### Outset Leg Dimensions

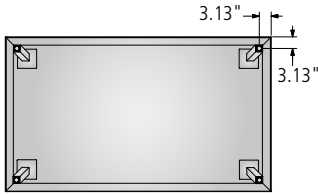

Note: Outset Leg option available on tables between 60" to 96" L.

### Inset Leg Dimensions

Sizes 60" to 96" L

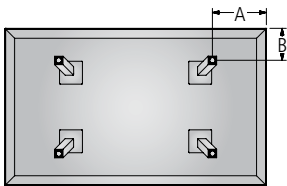

Sizes 102" to 144" L



Table Size	Base	A (End)	B (Side)
60 x 30	Post Leg	12.4	4.4
66 x 30	Post Leg	12.4	4.4
72 x 30	Post Leg	12.4	4.4
78 x 30	Post Leg	15.9	4.4
84 x 30	Post Leg	15.9	4.4
90 x 30	Post Leg	15.9	4.4
96 x 30	Post Leg	15.9	4.4
60 x 36	Post Leg	12.4	7.4
66 x 36	Post Leg	12.4	7.4
72 x 36	Post Leg	12.4	7.4
78 x 36	Post Leg	15.9	7.4
84 x 36	Post Leg	15.9	7.4
90 x 36	Post Leg	15.9	7.4
96 x 36	Post Leg	15.9	7.4
60 x 42	Post Leg	12.4	10.4
66 x 42	Post Leg	12.4	10.4
72 x 42	Post Leg	12.4	10.4
78 x 42	Post Leg	15.9	10.4
84 x 42	Post Leg	15.9	10.4
90 x 42	Post Leg	15.9	10.4
96 x 42	Post Leg	15.9	10.4
60 x 48	Post Leg	12.4	12.1
66 x 48	Post Leg	12.4	12.1
72 x 48	Post Leg	12.4	12.1
78 x 48	Post Leg	15.9	12.1
84 x 48	Post Leg	15.9	12.1
90 x 48	Post Leg	15.9	12.1
96 x 48	Post Leg	15.9	12.1
102 x 42	Post Leg	20.5	10.4
102 x 48	Post Leg	20.5	12.2
108 x 42	Post Leg	20.5	10.4
108 x 48	Post Leg	20.5	12.2
108 x 54	Post Leg	20.5	14.1
114 x 42	Post Leg	20.5	10.4
114 x 48	Post Leg	20.5	12.2
114 x 54	Post Leg	20.5	14.1
120 x 42	Post Leg	20.5	10.4
120 x 48	Post Leg	20.5	12.2
120 x 54	Post Leg	20.5	14.1
132 x 42	Post Leg	20.5	10.4
132 x 48	Post Leg	20.5	12.2
132 x 54	Post Leg	20.5	14.1
144 x 48	Post Leg	20.5	12.2
144 x 54	Post Leg	20.5	14.1
144 x 60	Post Leg	20.5	16.1



# BASE LOCATIONS

## SOFT RECTANGLE TABLE WITH POST LEGS

### Inset Leg Dimensions

Note: This is the only Post Leg position on Soft Rectangle tables.

Sizes 60" to 96"L

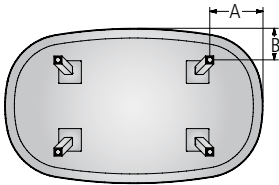

Sizes 102" to 144"L

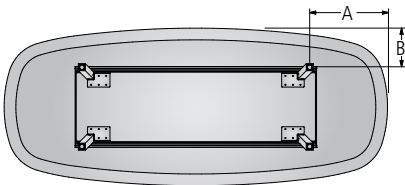

Table Size	Base	A (End)	B (Side)
60 x 30	Post Leg	12.2	4.4
66 x 30	Post Leg	12.2	4.4
72 x 30	Post Leg	12.2	4.4
78 x 30	Post Leg	15.7	4.4
84 x 30	Post Leg	15.7	4.4
90 x 30	Post Leg	15.7	4.4
96 x 30	Post Leg	15.7	4.4
60 x 36	Post Leg	12.2	7.4
66 x 36	Post Leg	12.2	7.4
72 x 36	Post Leg	12.2	7.4
78 x 36	Post Leg	15.7	7.4
84 x 36	Post Leg	15.7	7.4
90 x 36	Post Leg	15.7	7.4
96 x 36	Post Leg	15.7	7.4
60 x 42	Post Leg	12.2	10.4
66 x 42	Post Leg	12.2	10.4
72 x 42	Post Leg	12.2	10.4
78 x 42	Post Leg	15.7	10.4
84 x 42	Post Leg	15.7	10.4
90 x 42	Post Leg	15.7	10.4
96 x 42	Post Leg	15.7	10.4
60 x 48	Post Leg	12.2	12.1
66 x 48	Post Leg	12.2	12.1
72 x 48	Post Leg	12.2	12.1
78 x 48	Post Leg	15.7	12.1
84 x 48	Post Leg	15.7	12.1
90 x 48	Post Leg	15.7	12.1
96 x 48	Post Leg	15.7	12.1
102 x 42	Post Leg	20.5	10.4
102 x 48	Post Leg	20.5	12.2
108 x 42	Post Leg	20.5	10.4
108 x 48	Post Leg	20.5	12.2
108 x 54	Post Leg	20.5	14.1
114 x 42	Post Leg	20.5	10.4
114 x 48	Post Leg	20.5	12.2
114 x 54	Post Leg	20.5	14.1
120 x 42	Post Leg	20.5	10.4
120 x 48	Post Leg	20.5	12.2
120 x 54	Post Leg	20.5	14.1
132 x 42	Post Leg	20.5	10.4
132 x 48	Post Leg	20.5	12.2
132 x 54	Post Leg	20.5	14.1
144 x 48	Post Leg	20.5	12.2
144 x 54	Post Leg	20.5	14.1
144 x 60	Post Leg	20.5	16.1



# BASE LOCATIONS

## RECTANGLE AND SOFT RECTANGLE TABLES WITH POST LEGS AND RECTANGLE CENTER BASE

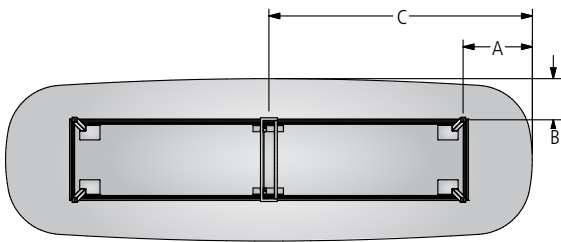
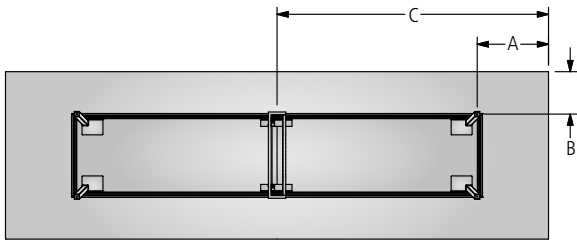

Table Size	Base	A (End)	B (Side)	C (Center)
156 x 48	Post Leg	20.5	12.2	78
156 x 54	Post Leg	20.5	14.1	78
156 x 60	Post Leg	20.5	16.1	78
168 x 54	Post Leg	20.5	14.1	84
168 x 60	Post Leg	20.5	16.1	84
180 x 54	Post Leg	20.5	14.1	90
180 x 60	Post Leg	20.5	16.1	90
192 x 54	Post Leg	20.5	14.1	96
192 x 60	Post Leg	20.5	16.1	96
204 x 54	Post Leg	20.5	14.1	102
204 x 60	Post Leg	20.5	16.1	102
216 x 54	Post Leg	20.5	14.1	108
216 x 60	Post Leg	20.5	16.1	108
228 x 54	Post Leg	20.5	14.1	114
228 x 60	Post Leg	20.5	16.1	114
240 x 54	Post Leg	20.5	14.1	120
240 x 60	Post Leg	20.5	16.1	120



# BASE LOCATIONS

## RECTANGLE AND SOFT RECTANGLE TABLES WITH OPEN FRAME

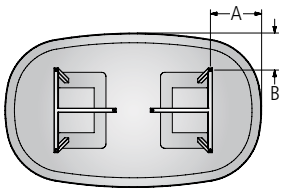
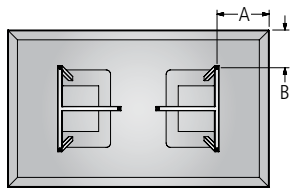

Table Size	Base	A (End)	B (Side)
60 x 30	Open Frame	12	6.8
66 x 30	Open Frame	12	6.8
72 x 30	Open Frame	12	6.8
78 x 30	Open Frame	15.5	6.8
84 x 30	Open Frame	15.5	6.8
90 x 30	Open Frame	15.5	6.8
96 x 30	Open Frame	15.5	6.8
60 x 36	Open Frame	12	8.6
66 x 36	Open Frame	12	8.6
72 x 36	Open Frame	12	8.6
78 x 36	Open Frame	15.5	8.6
84 x 36	Open Frame	15.5	8.6
90 x 36	Open Frame	15.5	8.6
96 x 36	Open Frame	15.5	8.6
60 x 42	Open Frame	12	10.4
66 x 42	Open Frame	12	10.4
72 x 42	Open Frame	12	10.4
78 x 42	Open Frame	15.5	10.4
84 x 42	Open Frame	15.5	10.4
90 x 42	Open Frame	15.5	10.4
96 x 42	Open Frame	15.5	10.4
60 x 48	Open Frame	12	12.1
66 x 48	Open Frame	12	12.1
72 x 48	Open Frame	12	12.1
78 x 48	Open Frame	15.5	12.1
84 x 48	Open Frame	15.5	12.1
90 x 48	Open Frame	15.5	12.1
96 x 48	Open Frame	15.5	12.1
102 x 42	Open Frame	20.5	10.4
102 x 48	Open Frame	20.5	12.1
108 x 42	Open Frame	20.5	10.4
108 x 48	Open Frame	20.5	12.1
108 x 54	Open Frame	20.5	14.1
114 x 42	Open Frame	20.5	10.4
114 x 48	Open Frame	20.5	12.1
114 x 54	Open Frame	20.5	14
120 x 42	Open Frame	20.5	10.4
120 x 48	Open Frame	20.5	12.1
120 x 54	Open Frame	20.5	14
132 x 42	Open Frame	20.5	10.4
132 x 48	Open Frame	20.5	12.1
132 x 54	Open Frame	20.5	14
144 x 48	Open Frame	20.5	12.1
144 x 54	Open Frame	20.5	14
144 x 60	Open Frame	20.5	16



# BASE LOCATIONS

## RECTANGLE AND SOFT RECTANGLE TABLES WITH OPEN FRAME AND X CENTER BASE

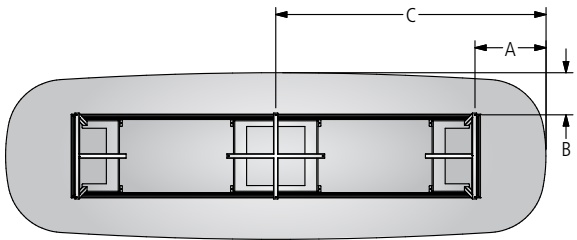
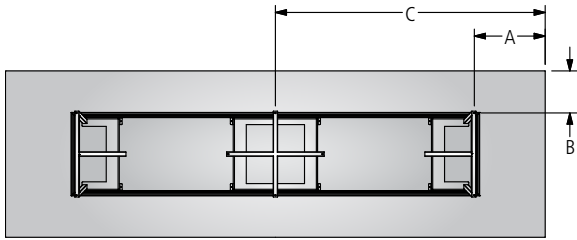

Table Size	Base	A (End)	B (Side)	C (Center)
156 x 48	Open Frame	20.5	12.1	78
156 x 54	Open Frame	20.5	14	78
156 x 60	Open Frame	20.5	16	78
168 x 54	Open Frame	20.5	14	84
168 x 60	Open Frame	20.5	16	84
180 x 54	Open Frame	20.5	14	90
180 x 60	Open Frame	20.5	16	90
192 x 54	Open Frame	20.5	14	96
192 x 60	Open Frame	20.5	16	96
204 x 54	Open Frame	20.5	14	102
204 x 60	Open Frame	20.5	16	102
216 x 54	Open Frame	20.5	14	108
216 x 60	Open Frame	20.5	16	108
228 x 54	Open Frame	20.5	14	114
228 x 60	Open Frame	20.5	16	114
240 x 54	Open Frame	20.5	14	120
240 x 60	Open Frame	20.5	16	120



# BASE LOCATIONS

## RECTANGLE AND SOFT RECTANGLE TABLES WITH RACETRACK BASE

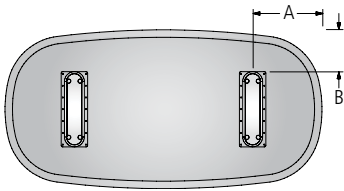
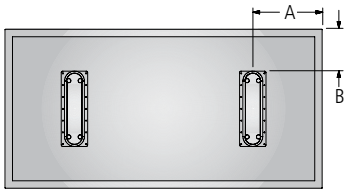

Table Size	Base	A (End)	B (Side)
72 x 42	Racetrack	21	10.38
78 x 42	Racetrack	21	10.38
84 x 42	Racetrack	21	10.38
90 x 42	Racetrack	21	10.38
96 x 42	Racetrack	21	10.38
72 x 48	Racetrack	21	12.63
78 x 48	Racetrack	21	12.63
84 x 48	Racetrack	21	12.63
90 x 48	Racetrack	21	12.63
96 x 48	Racetrack	21	12.63
102 x 42	Racetrack	26	10.38
102 x 48	Racetrack	26	12.63
108 x 42	Racetrack	26	10.38
108 x 48	Racetrack	26	12.63
108 x 54	Racetrack	26	14.56
114 x 42	Racetrack	26	10.38
114 x 48	Racetrack	26	12.63
114 x 54	Racetrack	26	14.56
120 x 42	Racetrack	26	10.38
120 x 48	Racetrack	26	12.63
120 x 54	Racetrack	26	14.56
132 x 42	Racetrack	26	10.38
132 x 48	Racetrack	26	12.63
132 x 54	Racetrack	26	14.56
144 x 48	Racetrack	26	12.63
144 x 54	Racetrack	26	14.56
144 x 60	Racetrack	26	16.56

## RECTANGLE AND SOFT RECTANGLE TABLES WITH RACETRACK BASE

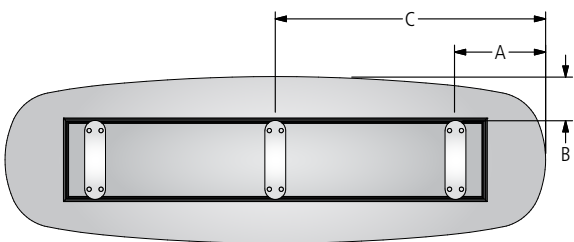
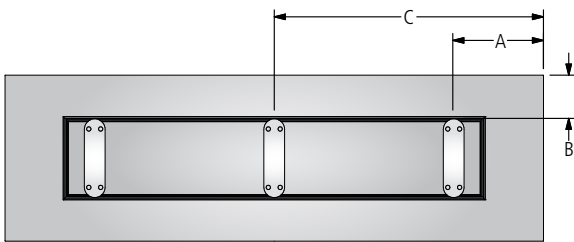

Table Size	Base	A (End)	B (Side)	C (Center)
156 x 48	Racetrack	26	12.63	78
156 x 54	Racetrack	26	14.56	78
156 x 60	Racetrack	26	16.56	78
168 x 54	Racetrack	26	14.56	84
168 x 60	Racetrack	26	16.56	84
180 x 54	Racetrack	26	14.56	90
180 x 60	Racetrack	26	16.56	90
192 x 54	Racetrack	26	14.56	96
192 x 60	Racetrack	26	16.56	96
204 x 54	Racetrack	26	14.56	102
204 x 60	Racetrack	26	16.56	102
216 x 54	Racetrack	26	14.56	108
216 x 60	Racetrack	26	16.56	108
228 x 54	Racetrack	26	14.56	114
228 x 60	Racetrack	26	16.56	114
240 x 54	Racetrack	26	14.56	120
240 x 60	Racetrack	26	16.56	120





## VENEER TOP WITH HARDWOOD EDGE



ROUND TOP



SQUARE TOP



SOFT SQUARE TOP

## BASE KEY

PC	Painted Cylinder
VY	Veneer Cylinder
OS	Open Frame Square
ML	Post Metal Leg

## ROUND TABLES

MODEL #	DIAMETER	SEATING CAPACITY	-PC	-VY	-OS	-ML
TFR-48-V	48	4	4,426	4,622	3,247	2,938
TFR-54-V	54	6	5,389	5,605	4,052	3,599
TFR-60-V	60	6	6,306	6,536	4,851	4,239

## SQUARE TABLES

MODEL #	LENGTH	WIDTH	SEATING CAPACITY	-OS	-ML
TFS-4848-V	48	48	4	3,247	2,938
TFS-5454-V	54	54	6	4,052	3,599
TFS-6060-V	60	60	6	4,851	4,239

## SOFT SQUARE TABLES

MODEL #	LENGTH	WIDTH	SEATING CAPACITY	-OS	-ML
TFQ-4848-V	48	48	4	3,247	2,938
TFQ-5454-V	54	54	6	4,052	3,599
TFQ-6060-V	60	60	6	4,851	4,239

## OPTIONS

## CODE

## PRICE

## NOTES

Power &amp; Data Options

See pages 123-133

## Polished Chrome Finish Options:

Polished Chrome Open Frame Square

Add -PCOS

\$1,075

Polished Chrome Post Metal Legs

Add -PCML-TWB

\$1,164

## EDGE PROFILE

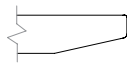

Two4Six Cutback Edge

## GENERAL INFORMATION

- Tops are 1-1/8"-thick with 3/16"-thick hardwood edge band
- Seating capacity based on 27" per person
- Overall table height 29.5"
- Standard with quarter cut veneer
- One section of wire management channel provided per table with Post Metal Leg and Open Frame Square Base

## REQUIRED INFORMATION (ORDER CANNOT BE ENTERED WITHOUT THIS INFORMATION)

See appendix pages vi-vii for surface material options.

- Choose Veneer Finish
- Choose Paint Finish, if -PC base is specified
- Choose Metal Finish only if -OS or -ML bases specified (Clear Anodized (-CA) is an option on the Post Metal Leg only)



## INSET LAMINATE TOP WITH HARDWOOD EDGE



ROUND TOP



SQUARE TOP



SOFT SQUARE TOP

## BASE KEY

PC	Painted Cylinder
VY	Veneer Cylinder
OS	Open Frame Square
ML	Post Metal Leg

## ROUND TABLES

MODEL #	DIAMETER	SEATING CAPACITY	-PC	-VY	-OS	-ML
TFR-48-P	48	4	4,181	4,366	3,068	2,776
TFR-54-P	54	6	5,091	5,295	3,828	3,400
TFR-60-P	60	6	5,957	6,175	4,582	4,005

## SQUARE TABLES

MODEL #	LENGTH	WIDTH	SEATING CAPACITY	-OS	-ML
TFS-4848-P	48	48	4	3,068	2,776
TFS-5454-P	54	54	6	3,828	3,400
TFS-6060-P	60	60	6	4,582	4,005

## SOFT SQUARE TABLES

MODEL #	LENGTH	WIDTH	SEATING CAPACITY	-OS	-ML
TFQ-4848-P	48	48	4	3,068	2,776
TFQ-5454-P	54	54	6	3,828	3,400
TFQ-6060-P	60	60	6	4,582	4,005

## OPTIONS

## CODE

## PRICE

## NOTES

Power &amp; Data Options

See pages 123-133

## Polished Chrome Finish Options:

Polished Chrome Open Frame Square

Add -PCOS

\$1,075

Polished Chrome Post Metal Legs

Add -PCML-TWB

\$1,164

## EDGE PROFILE

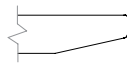

Two4Six Cutback Edge

## GENERAL INFORMATION

- Tops are 1-1/8"-thick with 3/16"-thick hardwood edge band
- Seating capacity based on 27" per person
- Overall table height 29.5"
- Standard with quarter cut veneer
- One section of wire management channel provided per table with Post Metal Leg and Open Frame Square Bases

## REQUIRED INFORMATION (ORDER CANNOT BE ENTERED WITHOUT THIS INFORMATION)

See appendix pages vi-vii for surface material options.

- Choose Laminate Finish
- Choose Wood Species & Finish
- Choose Paint Finish, if -PC base is specified
- Choose Veneer Finish, if -VY base is specified
- Choose Metal Finish, if -OS or -ML base is specified (Clear Anodized (-CA) is an option on the Post Metal Leg only)-



## LAMINATE TOP WITH ABS CUTBACK EDGE



ROUND TOP



SQUARE TOP



SOFT SQUARE TOP

## BASE KEY

PC	Painted Cylinder
VY	Veneer Cylinder
OS	Open Frame Square
ML	Post Metal Leg

## ROUND TABLES

MODEL #	DIAMETER	SEATING CAPACITY	-PC	-VY	-OS	-ML
TFR-48-PA	48	4	4,181	4,366	3,068	2,776
TFR-54-PA	54	6	5,091	5,295	3,828	3,400
TFR-60-PA	60	6	5,957	6,175	4,582	4,005

## SQUARE TABLES

MODEL #	LENGTH	WIDTH	SEATING CAPACITY	-OS	-ML
TFS-4848-PA	48	48	4	3,068	2,776
TFS-5454-PA	54	54	6	3,828	3,400
TFS-6060-PA	60	60	6	4,582	4,005

## SOFT SQUARE TABLES

MODEL #	LENGTH	WIDTH	SEATING CAPACITY	-OS	-ML
TFQ-4848-PA	48	48	4	3,068	2,776
TFQ-5454-PA	54	54	6	3,828	3,400
TFQ-6060-PA	60	60	6	4,582	4,005

## OPTIONS

## CODE

## PRICE

## NOTES

Power &amp; Data Options

See pages 123-133

## Polished Chrome Finish Options:

Polished Chrome Open Frame Square

Add -PCOS

\$1,075

Polished Chrome Post Metal Legs

Add -PCML-TWB

\$1,164

## EDGE PROFILE

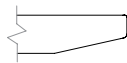

Two4Six Cutback Edge

## GENERAL INFORMATION

- Tops are 1-1/8" thick
- Seating capacity based on 27" per person
- Overall table height 29.5"
- Standard with quarter cut veneer
- One section of wire management channel provided per table with Post Metal Leg and Open Frame Square Bases

## REQUIRED INFORMATION (ORDER CANNOT BE ENTERED WITHOUT THIS INFORMATION)

See appendix pages vi-vii for surface material options.

- Choose Laminate Finish
- Choose ABS Edge Finish
- Choose Paint Finish, if -PC base is specified
- Choose Veneer Finish, if -VY base is specified
- Choose Metal Finish, if -OS or -ML base is specified (Clear Anodized (-CA) is an option on the Post Metal Leg only)



## LAMINATE TOP WITH ABS SQUARE EDGE



ROUND TOP



SQUARE TOP



SOFT SQUARE TOP

## BASE KEY

PC	Painted Cylinder
VY	Veneer Cylinder
OS	Open Frame Square
ML	Post Metal Leg

## ROUND TABLES

MODEL #	DIAMETER	SEATING CAPACITY	-PC	-VY	-OS	-ML
TFR-48-PE	48	4	3,936	4,111	2,888	2,613
TFR-54-PE	54	6	4,793	4,986	3,604	3,201
TFR-60-PE	60	6	5,609	5,813	4,314	3,771

## SQUARE TABLES

MODEL #	LENGTH	WIDTH	SEATING CAPECITY	-OS	-ML
TFS-4848-PE	48	48	4	2,374	2,137
TFS-5454-PE	54	54	6	2,805	2,479
TFS-6060-PE	60	60	6	3,337	2,902

## SOFT SQUARE TABLES

MODEL #	LENGTH	WIDTH	SEATING CAPECITY	-OS	-ML
TFQ-4848-PE	48	48	4	2,188	1,981
TFQ-5454-PE	54	54	6	2,581	2,293
TFQ-6060-PE	60	60	6	3,067	2,681

## OPTIONS

## CODE

## PRICE

## NOTES

Power &amp; Data Options

See pages 123-133

## Polished Chrome Finish Options:

Polished Chrome Open Frame Square

Add -PCOS

\$1,075

Polished Chrome Post Metal Legs

Add -PCML-TWB

\$1,164

## EDGE PROFILE



Two4Six Square Edge

## GENERAL INFORMATION

- Tops are 1-1/8" thick
- Seating capacity based on 27" per person
- Overall table height 29.5"
- Standard with quarter cut veneer
- One section of wire management channel provided per table with Post Metal Leg and Open Frame Square Bases

## REQUIRED INFORMATION (ORDER CANNOT BE ENTERED WITHOUT THIS INFORMATION)

See appendix pages vi-vii for surface material options.

- Choose Laminate Finish
- Choose ABS Edge Finish
- Choose Paint Finish, if -PC base is specified
- Choose Veneer Finish, if -VY base is specified
- Choose Metal Finish, if -OS or -ML base is specified (Clear Anodized (-CA) is an option on the Post Metal Leg only)



## GLASS TOP



ROUND TOP



SQUARE TOP



SOFT SQUARE TOP

## BASE KEY

PC	Painted Cylinder
VY	Veneer Cylinder
OS	Open Frame Square

## ROUND TABLES

MODEL #	DIAMETER	SEATING CAPACITY	-PC	-VY	-OS
TFR-48-G	48	4	8,122	8,482	5,960
TFR-54-G	54	6	9,889	10,287	7,435
TFR-60-G	60	6	11,573	11,995	8,902

## SQUARE TABLES

MODEL #	LENGTH	WIDTH	SEATING CAPACITY	-OS
TFS-4848-G	48	48	4	5,960
TFS-5454-G	54	54	6	7,435
TFS-6060-G	60	60	6	8,902

## SOFT SQUARE TABLES

MODEL #	LENGTH	WIDTH	SEATING CAPACITY	-OS
TFQ-4848-G	48	48	4	5,960
TFQ-5454-G	54	54	6	7,435
TFQ-6060-G	60	60	6	8,902

## OPTIONS

## CODE

## PRICE

## NOTES

Power &amp; Data Options

See pages 123-133

## Polished Chrome Finish Options:

Polished Chrome Open Frame Square

Add -PCOS

\$1,075

Polished Chrome Post Metal Legs

Add -PCML-TWB

\$1,164

## EDGE PROFILE

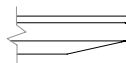

Two4Six Glass Edge

## GENERAL INFORMATION

- Tops are 1-1/8"-thick with 3/16"-thick hardwood edge band
- Seating capacity based on 27" per person
- Overall table height 29.5"
- Standard with quarter cut veneer
- One section of wire management channel provided per table with Post Metal Leg and Open Frame Square Bases

## REQUIRED INFORMATION (ORDER CANNOT BE ENTERED WITHOUT THIS INFORMATION)

See appendix pages vi-vii for surface material options.

- Choose Glass Finish
- Choose Veneer Finish, if applicable
- Choose Metal Finish, if applicable
- Choose Paint Finish, if applicable
- Choose Sub-Top Finish: Paint Finish or Wood Species & Finish



## SOLID SURFACE TOP



ROUND TOP



SQUARE TOP



SOFT SQUARE TOP

## BASE KEY

PC	Painted Cylinder
VY	Veneer Cylinder
OS	Open Frame Square

## ROUND TABLES

MODEL #	DIAMETER	SEATING CAPACITY	-PC	-VY	-OS
TFR-48-SS	48	4	8,486	8,863	6,227
TFR-54-SS	54	6	10,333	10,749	7,769
TFR-60-SS	60	6	12,092	12,534	9,301

## SQUARE TABLES

MODEL #	LENGTH	WIDTH	SEATING CAPACITY	-OS
TFS-4848-SS	48	48	4	6,227
TFS-5454-SS	54	54	6	7,769
TFS-6060-SS	60	60	6	9,301

## SOFT SQUARE TABLES

MODEL #	LENGTH	WIDTH	SEATING CAPACITY	-OS
TFQ-4848-SS	48	48	4	6,227
TFQ-5454-SS	54	54	6	7,769
TFQ-6060-SS	60	60	6	9,301

## OPTIONS

## CODE

## PRICE

## NOTES

Power &amp; Data Options

See pages 123-133

## Polished Chrome Finish Options:

Polished Chrome Open Frame Square

Add -PCOS

\$1,075

## EDGE PROFILE

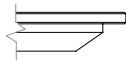

Two4Six Solid Surface Edge

## GENERAL INFORMATION

- Seating capacity based on 27" per person
- Overall table height 29.5"
- Standard with quarter cut veneer
- One section of wire management channel provided per table with Post Metal Leg and Open Frame Square Bases

## REQUIRED INFORMATION (ORDER CANNOT BE ENTERED WITHOUT THIS INFORMATION)

See appendix pages vi-vii for surface material options.

- Choose Solid Surface Finish
- Choose Veneer Finish, if applicable
- Choose Metal Finish, if applicable
- Choose Paint Finish, if applicable



## STONE / QUARTZ TOP



ROUND TOP



SQUARE TOP



SOFT SQUARE TOP

## BASE KEY

PC	Painted Cylinder
VY	Veneer Cylinder
OS	Open Frame Square

## ROUND TABLES

MODEL #	DIAMETER	SEATING CAPACITY	-PC	-VY	-OS
TFR-48-S	48	4	10,048	10,494	7,373
TFR-54-S	54	6	12,235	12,727	9,199

## SQUARE TABLES

MODEL #	LENGTH	WIDTH	SEATING CAPACITY	-OS
TFS-4848-S	48	48	4	7,373
TFS-5454-S	54	54	6	9,199

## SOFT SQUARE TABLES

MODEL #	LENGTH	WIDTH	SEATING CAPACITY	-OS
TFQ-4848-S	48	48	4	7,373
TFQ-5454-S	54	54	6	9,199

## OPTIONS

## CODE

## PRICE

## NOTES

Power &amp; Data Options

See pages 123-133

## Polished Chrome Finish Options:

Polished Chrome Open Frame Square

Add -PCOS

\$1,075

## EDGE PROFILE

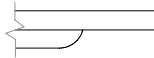

Two4Six Stone / Quartz Edge

## GENERAL INFORMATION

- Seating capacity based on 27" per person
- Overall table height 29.5"
- One section of wire management channel provided per table with Post Metal Leg and Open Frame Square Bases

## REQUIRED INFORMATION (ORDER CANNOT BE ENTERED WITHOUT THIS INFORMATION)

See appendix pages vi-vii for surface material options.

- Choose Stone/Quartz Finish
- Choose Veneer Finish, if applicable
- Choose Metal Finish
- Choose Paint Finish, if applicable



# VENEER TOP WITH HARDWOOD EDGE



RECTANGLE TOP

**BASE KEY**

- OF Open Frame
- OFX Open Frame with X Center Base
- OFRP Open Frame with Painted Rectangle Center Base
- OFRV Open Frame with Veneer Rectangle Center Base

- RCL Laminate Racetrack Base
- RCP Painted Racetrack Base
- RCV Veneer Racetrack Base

- ML Post Metal Leg
- MLX Post Metal Leg with X Center Base
- MLRP Post Metal Leg with Painted Rectangle Center Base
- MLRV Post Metal Leg with Veneer Rectangle Center Base

**RECTANGLE TABLES**

MODEL #	L x W	BASE QTY	TOP SECTIONS	SEATING CAPACITY	-OF	-OFX	-OFRP	-OFRV	-RCL	-RCP	-RCV	-ML	-MLX	-MLRP	-MLRV
TFT-6030-V	60 x 30	2	1	4	3,790	-	-	-	-	-	-	2,831	-	-	-
TFT-6036-V	60 x 36	2	1	4	3,986	-	-	-	-	-	-	2,980	-	-	-
TFT-6042-V	60 x 42	2	1	4	4,547	-	-	-	-	-	-	3,402	-	-	-
TFT-6048-V	60 x 48	2	1	4	4,925	-	-	-	-	-	-	3,687	-	-	-
TFT-6630-V	66 x 30	2	1	4	4,131	-	-	-	-	-	-	3,093	-	-	-
TFT-6636-V	66 x 36	2	1	4	4,358	-	-	-	-	-	-	3,266	-	-	-
TFT-6642-V	66 x 42	2	1	4	4,986	-	-	-	-	-	-	3,740	-	-	-
TFT-6648-V	66 x 48	2	1	4	5,414	-	-	-	-	-	-	4,063	-	-	-
TFT-7230-V	72 x 30	2	1	6	4,260	-	-	-	-	-	-	3,199	-	-	-
TFT-7236-V	72 x 36	2	1	6	4,508	-	-	-	-	-	-	3,387	-	-	-
TFT-7242-V	72 x 42	2	1	6	5,172	-	-	-	5,172	5,429	5,673	3,888	-	-	-
TFT-7248-V	72 x 48	2	1	6	5,629	-	-	-	5,629	5,895	6,148	4,235	-	-	-
TFT-7830-V	78 x 30	2	1	6	4,694	-	-	-	-	-	-	3,532	-	-	-
TFT-7836-V	78 x 36	2	1	6	4,981	-	-	-	-	-	-	3,750	-	-	-
TFT-7842-V	78 x 42	2	1	6	5,730	-	-	-	5,730	6,005	6,266	4,316	-	-	-
TFT-7848-V	78 x 48	2	1	6	6,251	-	-	-	6,251	6,535	6,805	4,711	-	-	-
TFT-8430-V	84 x 30	2	1	8	4,833	-	-	-	-	-	-	3,644	-	-	-
TFT-8436-V	84 x 36	2	1	8	5,142	-	-	-	-	-	-	3,879	-	-	-
TFT-8442-V	84 x 42	2	1	8	5,929	-	-	-	5,929	6,203	6,465	4,475	-	-	-
TFT-8448-V	84 x 48	2	1	8	6,481	-	-	-	6,481	6,765	7,036	4,894	-	-	-
TFT-9030-V	90 x 30	2	1	8	5,230	-	-	-	-	-	-	3,951	-	-	-
TFT-9036-V	90 x 36	2	1	8	5,579	-	-	-	-	-	-	4,217	-	-	-
TFT-9042-V	90 x 42	2	1	8	6,446	-	-	-	6,446	6,735	7,010	4,874	-	-	-
TFT-9048-V	90 x 48	2	1	8	7,060	-	-	-	7,060	7,359	7,643	5,340	-	-	-
TFT-9630-V	96 x 30	2	1	8	5,375	-	-	-	-	-	-	4,070	-	-	-
TFT-9636-V	96 x 36	2	1	8	5,747	-	-	-	-	-	-	4,353	-	-	-
TFT-9642-V	96 x 42	2	1	8	6,655	-	-	-	6,655	6,944	7,219	5,041	-	-	-
TFT-9648-V	96 x 48	2	1	8	7,302	-	-	-	7,302	7,601	7,885	5,532	-	-	-
TFT-10242-V	102 x 42	2	1	8	7,244	-	-	-	7,244	7,549	7,839	5,497	-	-	-
TFT-10248-V	102 x 48	2	1	8	7,964	-	-	-	7,964	8,279	8,579	6,043	-	-	-
TFT-10842-V	108 x 42	2	1	10	7,465	-	-	-	7,465	7,770	8,060	5,673	-	-	-
TFT-10848-V	108 x 48	2	1	10	8,220	-	-	-	8,220	8,535	8,835	6,245	-	-	-
TFT-10854-V	108 x 54	2	1	10	9,104	-	-	-	9,104	9,433	9,747	6,918	-	-	-
TFT-11442-V	114 x 42	2	1	10	8,091	-	-	-	8,091	8,412	8,717	6,156	-	-	-
TFT-11448-V	114 x 48	2	1	10	8,921	-	-	-	8,921	9,253	9,569	6,788	-	-	-
TFT-11454-V	114 x 54	2	1	12	9,894	-	-	-	9,894	10,241	10,571	7,528	-	-	-
TFT-12042-V	120 x 42	2	1	10	8,322	-	-	-	8,322	8,643	8,949	6,341	-	-	-
TFT-12048-V	120 x 48	2	1	10	9,191	-	-	-	9,191	9,523	9,839	7,002	-	-	-
TFT-12054-V	120 x 54	2	1	12	10,206	-	-	-	10,206	10,553	10,883	7,775	-	-	-
TFT-13242-V	132 x 42	2	2	10	9,153	-	-	-	9,153	9,487	9,805	6,991	-	-	-
TFT-13248-V	132 x 48	2	2	10	10,134	-	-	-	10,134	10,480	10,809	7,739	-	-	-
TFT-13254-V	132 x 54	2	2	12	11,280	-	-	-	11,280	11,642	11,985	8,612	-	-	-
TFT-14448-V	144 x 48	2	2	12	11,123	-	-	-	11,123	11,483	11,825	8,511	-	-	-
TFT-14454-V	144 x 54	2	2	14	12,406	-	-	-	12,406	12,782	13,140	9,490	-	-	-
TFT-14460-V	144 x 60	2	2	14	13,897	-	-	-	13,897	14,293	14,670	10,626	-	-	-
TFT-15648-V	156 x 48	3	2	14	-	14,177	14,177	14,177	14,177	14,722	15,240	-	10,867	10,867	10,867
TFT-15654-V	156 x 54	3	2	14	-	15,669	15,669	15,669	15,669	16,239	16,780	-	12,006	12,006	12,006
TFT-15660-V	156 x 60	3	2	14	-	17,412	17,412	17,412	17,412	18,012	18,582	-	13,336	13,336	13,336
TFT-16854-V	168 x 54	3	2	16	-	16,436	16,436	16,436	16,436	17,005	17,547	-	12,630	12,630	12,630
TFT-16860-V	168 x 60	3	2	16	-	18,290	18,290	18,290	18,290	18,889	19,460	-	14,046	14,046	14,046
TFT-18054-V	180 x 54	3	2	16	-	17,202	17,202	17,202	17,202	17,772	18,313	-	13,253	13,253	13,253
TFT-18060-V	180 x 60	3	2	16	-	19,166	19,166	19,166	19,166	19,766	20,336	-	14,755	14,755	14,755
TFT-19254-V	192 x 54	3	2	18	-	17,969	17,969	17,969	17,969	18,538	19,080	-	13,876	13,876	13,876
TFT-19260-V	192 x 60	3	2	18	-	20,044	20,044	20,044	20,044	20,643	21,214	-	15,465	15,465	15,465
TFT-20454-V	204 x 54	3	2	18	-	19,495	19,495	19,495	19,495	20,088	20,651	-	15,088	15,088	15,088
TFT-20460-V	204 x 60	3	2	18	-	21,770	21,770	21,770	21,770	22,394	22,988	-	16,832	16,832	16,832
TFT-21654-V	216 x 54	3	2	20	-	20,787	20,787	20,787	20,787	21,394	21,972	-	16,121	16,121	16,121
TFT-21660-V	216 x 60	3	2	20	-	23,235	23,235	23,235	23,235	23,875	24,483	-	17,999	17,999	17,999
TFT-22854-V	228 x 54	3	2	20	-	21,810	21,810	21,810	21,810	22,423	23,006	-	16,945	16,945	16,945
TFT-22860-V	228 x 60	3	2	20	-	24,401	24,401	24,401	24,401	25,046	25,660	-	18,934	18,934	18,934
TFT-24054-V	240 x 54	3	2	20	-	22,891	22,891	22,891	22,891	23,511	24,100	-	17,815	17,815	17,815
TFT-24060-V	240 x 60	3	2	20	-	25,631	25,631	25,631	25,631	26,284	26,905	-	19,921	19,921	19,921





# VENEER TOP WITH HARDWOOD EDGE

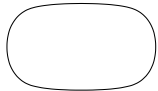

SOFT RECTANGLE TOP

**BASE KEY**

- OF Open Frame
- OFX Open Frame with X Center Base
- OFRP Open Frame with Painted Rectangle Center Base
- OFRV Open Frame with Veneer Rectangle Center Base
- RCL Laminate Racetrack Base
- RCP Painted Racetrack Base
- RCV Veneer Racetrack Base
- ML Post Metal Leg
- MLX Post Metal Leg with X Center Base
- MLRP Post Metal Leg with Painted Rectangle Center Base
- MLRV Post Metal Leg with Veneer Rectangle Center Base

**SOFT RECTANGLE TABLES**

MODEL #	L x W	BASE QTY	TOP SECTIONS	SEATING CAPACITY	-OF	-OFX	-OFRP	-OFRV	-RCL	-RCP	-RCV	-ML	-MLX	-MLRP	-MLRV
TFF-6030-V	60 x 30	2	1	4	3,790	-	-	-	-	-	-	2,831	-	-	-
TFF-6036-V	60 x 36	2	1	4	3,986	-	-	-	-	-	-	2,980	-	-	-
TFF-6042-V	60 x 42	2	1	4	4,547	-	-	-	-	-	-	3,402	-	-	-
TFF-6048-V	60 x 48	2	1	4	4,925	-	-	-	-	-	-	3,687	-	-	-
TFF-6630-V	66 x 30	2	1	4	4,131	-	-	-	-	-	-	3,093	-	-	-
TFF-6636-V	66 x 36	2	1	4	4,358	-	-	-	-	-	-	3,266	-	-	-
TFF-6642-V	66 x 42	2	1	4	4,986	-	-	-	-	-	-	3,740	-	-	-
TFF-6648-V	66 x 48	2	1	4	5,414	-	-	-	-	-	-	4,063	-	-	-
TFF-7230-V	72 x 30	2	1	6	4,260	-	-	-	-	-	-	3,199	-	-	-
TFF-7236-V	72 x 36	2	1	6	4,508	-	-	-	-	-	-	3,387	-	-	-
TFF-7242-V	72 x 42	2	1	6	5,172	-	-	-	5,172	5,429	5,673	3,888	-	-	-
TFF-7248-V	72 x 48	2	1	6	5,629	-	-	-	5,629	5,895	6,148	4,235	-	-	-
TFF-7830-V	78 x 30	2	1	6	4,694	-	-	-	-	-	-	3,532	-	-	-
TFF-7836-V	78 x 36	2	1	6	4,981	-	-	-	-	-	-	3,750	-	-	-
TFF-7842-V	78 x 42	2	1	6	5,730	-	-	-	5,730	6,005	6,266	4,316	-	-	-
TFF-7848-V	78 x 48	2	1	6	6,251	-	-	-	6,251	6,535	6,805	4,711	-	-	-
TFF-8430-V	84 x 30	2	1	8	4,833	-	-	-	-	-	-	3,644	-	-	-
TFF-8436-V	84 x 36	2	1	8	5,142	-	-	-	-	-	-	3,879	-	-	-
TFF-8442-V	84 x 42	2	1	8	5,929	-	-	-	5,929	6,203	6,465	4,475	-	-	-
TFF-8448-V	84 x 48	2	1	8	6,481	-	-	-	6,481	6,765	7,036	4,894	-	-	-
TFF-9030-V	90 x 30	2	1	8	5,230	-	-	-	-	-	-	3,951	-	-	-
TFF-9036-V	90 x 36	2	1	8	5,579	-	-	-	-	-	-	4,217	-	-	-
TFF-9042-V	90 x 42	2	1	8	6,446	-	-	-	6,446	6,735	7,010	4,874	-	-	-
TFF-9048-V	90 x 48	2	1	8	7,060	-	-	-	7,060	7,359	7,643	5,340	-	-	-
TFF-9630-V	96 x 30	2	1	8	5,375	-	-	-	-	-	-	4,070	-	-	-
TFF-9636-V	96 x 36	2	1	8	5,747	-	-	-	-	-	-	4,353	-	-	-
TFF-9642-V	96 x 42	2	1	8	6,655	-	-	-	6,655	6,944	7,219	5,041	-	-	-
TFF-9648-V	96 x 48	2	1	8	7,302	-	-	-	7,302	7,601	7,885	5,532	-	-	-
TFF-10242-V	102 x 42	2	1	8	7,244	-	-	-	7,244	7,549	7,839	5,497	-	-	-
TFF-10248-V	102 x 48	2	1	8	7,964	-	-	-	7,964	8,279	8,579	6,043	-	-	-
TFF-10842-V	108 x 42	2	1	10	7,465	-	-	-	7,465	7,770	8,060	5,673	-	-	-
TFF-10848-V	108 x 48	2	1	10	8,220	-	-	-	8,220	8,535	8,835	6,245	-	-	-
TFF-10854-V	108 x 54	2	1	10	9,104	-	-	-	9,104	9,433	9,747	6,918	-	-	-
TFF-11442-V	114 x 42	2	1	10	8,091	-	-	-	8,091	8,412	8,717	6,156	-	-	-
TFF-11448-V	114 x 48	2	1	10	8,921	-	-	-	8,921	9,253	9,569	6,788	-	-	-
TFF-11454-V	114 x 54	2	1	12	9,894	-	-	-	9,894	10,241	10,571	7,528	-	-	-
TFF-12042-V	120 x 42	2	1	10	8,322	-	-	-	8,322	8,643	8,949	6,341	-	-	-
TFF-12048-V	120 x 48	2	1	10	9,191	-	-	-	9,191	9,523	9,839	7,002	-	-	-
TFF-12054-V	120 x 54	2	1	12	10,206	-	-	-	10,206	10,553	10,883	7,775	-	-	-
TFF-13242-V	132 x 42	2	2	10	9,153	-	-	-	9,153	9,487	9,805	6,991	-	-	-
TFF-13248-V	132 x 48	2	2	10	10,134	-	-	-	10,134	10,480	10,809	7,739	-	-	-
TFF-13254-V	132 x 54	2	2	12	11,280	-	-	-	11,280	11,642	11,985	8,612	-	-	-
TFF-14448-V	144 x 48	2	2	12	11,123	-	-	-	11,123	11,483	11,825	8,511	-	-	-
TFF-14454-V	144 x 54	2	2	14	12,406	-	-	-	12,406	12,782	13,140	9,490	-	-	-
TFF-14460-V	144 x 60	2	2	14	13,897	-	-	-	13,897	14,293	14,670	10,626	-	-	-
TFF-15648-V	156 x 48	3	2	14	-	14,177	14,177	14,177	14,177	14,722	15,240	-	10,867	10,867	10,867
TFF-15654-V	156 x 54	3	2	14	-	15,669	15,669	15,669	15,669	16,239	16,780	-	12,006	12,006	12,006
TFF-15660-V	156 x 60	3	2	14	-	17,412	17,412	17,412	17,412	18,012	18,582	-	13,336	13,336	13,336
TFF-16854-V	168 x 54	3	2	16	-	16,436	16,436	16,436	16,436	17,005	17,547	-	12,630	12,630	12,630
TFF-16860-V	168 x 60	3	2	16	-	18,290	18,290	18,290	18,290	18,889	19,460	-	14,046	14,046	14,046
TFF-18054-V	180 x 54	3	2	16	-	17,202	17,202	17,202	17,202	17,772	18,313	-	13,253	13,253	13,253
TFF-18060-V	180 x 60	3	2	16	-	19,166	19,166	19,166	19,166	19,766	20,336	-	14,755	14,755	14,755
TFF-19254-V	192 x 54	3	2	18	-	17,969	17,969	17,969	17,969	18,538	19,080	-	13,876	13,876	13,876
TFF-19260-V	192 x 60	3	2	18	-	20,044	20,044	20,044	20,044	20,643	21,214	-	15,465	15,465	15,465
TFF-20454-V	204 x 54	3	2	18	-	19,495	19,495	19,495	19,495	20,088	20,651	-	15,088	15,088	15,088
TFF-20460-V	204 x 60	3	2	18	-	21,770	21,770	21,770	21,770	22,394	22,988	-	16,832	16,832	16,832
TFF-21654-V	216 x 54	3	2	20	-	20,787	20,787	20,787	20,787	21,394	21,972	-	16,121	16,121	16,121
TFF-21660-V	216 x 60	3	2	20	-	23,235	23,235	23,235	23,235	23,875	24,483	-	17,999	17,999	17,999
TFF-22854-V	228 x 54	3	2	20	-	21,810	21,810	21,810	21,810	22,423	23,006	-	16,945	16,945	16,945
TFF-22860-V	228 x 60	3	2	20	-	24,401	24,401	24,401	24,401	25,046	25,660	-	18,934	18,934	18,934
TFF-24054-V	240 x 54	3	2	20	-	22,891	22,891	22,891	22,891	23,511	24,100	-	17,815	17,815	17,815
TFF-24060-V	240 x 60	3	2	20	-	25,631	25,631	25,631	25,631	26,284	26,905	-	19,921	19,921	19,921



# VENEER TOP WITH HARDWOOD EDGE

OPTIONS	CODE	PRICE	NOTES
Power & Data Options			See pages 123-133
<b>Polished Chrome Finish Options:</b>			
Polished Chrome Open Frame Base	Add -PCOF-TWB	\$2,169	
Polished Chrome Post Metal Legs	Add -PCML-TWB	\$1,164	
Polished Chrome Open Frame with X-Center Base	Add -PCOFX-TWB	\$3,252	
Polished Chrome Post Metal Legs with X-Center Base	Add -PCMLX-TWB	\$2,247	
<b>Multi-Section Tops:</b>			
102", 108", 114" and 120" one-piece tops split into two sections	Specify -2	\$764	Note: Power Matrix (center of table location only) cannot be specified when this option is selected
204", 216", 228" or 240" two-piece tops split into four sections	Specify -4	\$1,524	

## EDGE PROFILE

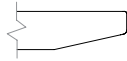

Two4Six Cutback Edge

## GENERAL INFORMATION

- Tops are 1-1/8"-thick with 3/16"-thick hardwood edge band
- Seating capacity based on 27" per person
- Overall table height 29.5"
- Standard with quarter cut veneer
- One section of wire management channel provided per table with Post Metal Leg and Open Frame Square Bases
- Racetrack Bases have a removable access door

### REQUIRED INFORMATION (ORDER CANNOT BE ENTERED WITHOUT THIS INFORMATION)

See appendix pages vi-vii for surface material options.

- Choose Veneer Finish
- Choose Metal Finish only if -OF or -ML bases specified (Clear Anodized (-CA) is an option on the Post Metal Leg only)
- Choose Beam Metal Finish for tables 102"-240" L, with a Racetrack Base (-RCL, -RCP, -RCV)



# INSET LAMINATE TOP WITH HARDWOOD EDGE



RECTANGLE TOP

**BASE KEY**

- OF Open Frame
- OFX Open Frame with X Center Base
- OFRP Open Frame with Painted Rectangle Center Base
- OFRV Open Frame with Veneer Rectangle Center Base
- RCL Laminate Racetrack Base
- RCP Painted Racetrack Base
- RCV Veneer Racetrack Base
- ML Post Metal Leg
- MLX Post Metal Leg with X Center Base
- MLRP Post Metal Leg with Painted Rectangle Center Base
- MLRV Post Metal Leg with Veneer Rectangle Center Base

**RECTANGLE TABLES**

MODEL #	L x W	BASE QTY	TOP SECTIONS	SEATING CAPACITY	-OF	-OFX	-OFRP	-OFRV	-RCL	-RCP	-RCV	-ML	-MLX	-MLRP	-MLRV
TFT-6030-P	60 x 30	2	1	4	3,582	-	-	-	-	-	-	2,676	-	-	-
TFT-6036-P	60 x 36	2	1	4	3,767	-	-	-	-	-	-	2,817	-	-	-
TFT-6042-P	60 x 42	2	1	4	4,297	-	-	-	-	-	-	3,215	-	-	-
TFT-6048-P	60 x 48	2	1	4	4,655	-	-	-	-	-	-	3,485	-	-	-
TFT-6630-P	66 x 30	2	1	4	3,904	-	-	-	-	-	-	2,923	-	-	-
TFT-6636-P	66 x 36	2	1	4	4,119	-	-	-	-	-	-	3,087	-	-	-
TFT-6642-P	66 x 42	2	1	4	4,712	-	-	-	-	-	-	3,535	-	-	-
TFT-6648-P	66 x 48	2	1	4	5,117	-	-	-	-	-	-	3,840	-	-	-
TFT-7230-P	72 x 30	2	1	6	4,026	-	-	-	-	-	-	3,024	-	-	-
TFT-7236-P	72 x 36	2	1	6	4,261	-	-	-	-	-	-	3,201	-	-	-
TFT-7242-P	72 x 42	2	1	6	4,888	-	-	-	4,888	5,131	5,361	3,675	-	-	-
TFT-7248-P	72 x 48	2	1	6	5,320	-	-	-	5,320	5,571	5,810	4,003	-	-	-
TFT-7830-P	78 x 30	2	1	6	4,436	-	-	-	-	-	-	3,338	-	-	-
TFT-7836-P	78 x 36	2	1	6	4,708	-	-	-	-	-	-	3,544	-	-	-
TFT-7842-P	78 x 42	2	1	6	5,415	-	-	-	5,415	5,675	5,922	4,079	-	-	-
TFT-7848-P	78 x 48	2	1	6	5,908	-	-	-	5,908	6,176	6,431	4,452	-	-	-
TFT-8430-P	84 x 30	2	1	8	4,568	-	-	-	-	-	-	3,444	-	-	-
TFT-8436-P	84 x 36	2	1	8	4,860	-	-	-	-	-	-	3,666	-	-	-
TFT-8442-P	84 x 42	2	1	8	5,603	-	-	-	5,603	5,862	6,110	4,229	-	-	-
TFT-8448-P	84 x 48	2	1	8	6,125	-	-	-	6,125	6,393	6,650	4,625	-	-	-
TFT-9030-P	90 x 30	2	1	8	4,943	-	-	-	-	-	-	3,734	-	-	-
TFT-9036-P	90 x 36	2	1	8	5,273	-	-	-	-	-	-	3,986	-	-	-
TFT-9042-P	90 x 42	2	1	8	6,092	-	-	-	6,092	6,365	6,625	4,606	-	-	-
TFT-9048-P	90 x 48	2	1	8	6,672	-	-	-	6,672	6,955	7,223	5,047	-	-	-
TFT-9630-P	96 x 30	2	1	8	5,080	-	-	-	-	-	-	3,847	-	-	-
TFT-9636-P	96 x 36	2	1	8	5,431	-	-	-	-	-	-	4,114	-	-	-
TFT-9642-P	96 x 42	2	1	8	6,289	-	-	-	6,289	6,563	6,822	4,764	-	-	-
TFT-9648-P	96 x 48	2	1	8	6,901	-	-	-	6,901	7,183	7,452	5,228	-	-	-
TFT-10242-P	102 x 42	2	1	8	6,846	-	-	-	6,846	7,134	7,408	5,195	-	-	-
TFT-10248-P	102 x 48	2	1	8	7,526	-	-	-	7,526	7,824	8,108	5,711	-	-	-
TFT-10842-P	108 x 42	2	1	10	7,055	-	-	-	7,055	7,343	7,617	5,361	-	-	-
TFT-10848-P	108 x 48	2	1	10	7,768	-	-	-	7,768	8,066	8,350	5,902	-	-	-
TFT-10854-P	108 x 54	2	1	10	8,604	-	-	-	8,604	8,915	9,211	6,538	-	-	-
TFT-11442-P	114 x 42	2	1	10	7,646	-	-	-	7,646	7,950	8,238	5,818	-	-	-
TFT-11448-P	114 x 48	2	1	10	8,431	-	-	-	8,431	8,745	9,043	6,415	-	-	-
TFT-11454-P	114 x 54	2	1	12	9,350	-	-	-	9,350	9,678	9,990	7,114	-	-	-
TFT-12042-P	120 x 42	2	1	10	7,865	-	-	-	7,865	8,168	8,457	5,993	-	-	-
TFT-12048-P	120 x 48	2	1	10	8,686	-	-	-	8,686	9,000	9,298	6,617	-	-	-
TFT-12054-P	120 x 54	2	1	12	9,645	-	-	-	9,645	9,973	10,285	7,348	-	-	-
TFT-13242-P	132 x 42	2	2	10	8,650	-	-	-	8,650	8,966	9,266	6,607	-	-	-
TFT-13248-P	132 x 48	2	2	10	9,577	-	-	-	9,577	9,904	10,215	7,314	-	-	-
TFT-13254-P	132 x 54	2	2	12	10,660	-	-	-	10,660	11,002	11,326	8,139	-	-	-
TFT-14448-P	144 x 48	2	2	12	10,512	-	-	-	10,512	10,852	11,175	8,043	-	-	-
TFT-14454-P	144 x 54	2	2	14	11,724	-	-	-	11,724	12,079	12,418	8,969	-	-	-
TFT-14460-P	144 x 60	2	2	14	13,133	-	-	-	13,133	13,507	13,864	10,042	-	-	-
TFT-15648-P	156 x 48	3	2	14	-	13,398	13,398	13,398	13,398	13,913	14,402	-	10,270	10,270	10,270
TFT-15654-P	156 x 54	3	2	14	-	14,808	14,808	14,808	14,808	15,346	15,858	-	11,346	11,346	11,346
TFT-15660-P	156 x 60	3	2	14	-	16,455	16,455	16,455	16,455	17,022	17,560	-	12,603	12,603	12,603
TFT-16854-P	168 x 54	3	2	16	-	15,533	15,533	15,533	15,533	16,070	16,582	-	11,936	11,936	11,936
TFT-16860-P	168 x 60	3	2	16	-	17,285	17,285	17,285	17,285	17,851	18,390	-	13,274	13,274	13,274
TFT-18054-P	180 x 54	3	2	16	-	16,256	16,256	16,256	16,256	16,795	17,306	-	12,525	12,525	12,525
TFT-18060-P	180 x 60	3	2	16	-	18,112	18,112	18,112	18,112	18,679	19,218	-	13,944	13,944	13,944
TFT-19254-P	192 x 54	3	2	18	-	16,981	16,981	16,981	16,981	17,519	18,031	-	13,113	13,113	13,113
TFT-19260-P	192 x 60	3	2	18	-	18,942	18,942	18,942	18,942	19,508	20,048	-	14,615	14,615	14,615
TFT-20454-P	204 x 54	3	2	18	-	18,423	18,423	18,423	18,423	18,984	19,516	-	14,259	14,259	14,259
TFT-20460-P	204 x 60	3	2	18	-	20,573	20,573	20,573	20,573	21,163	21,724	-	15,907	15,907	15,907
TFT-21654-P	216 x 54	3	2	20	-	19,644	19,644	19,644	19,644	20,218	20,764	-	15,235	15,235	15,235
TFT-21660-P	216 x 60	3	2	20	-	21,958	21,958	21,958	21,958	22,562	23,137	-	17,010	17,010	17,010
TFT-22854-P	228 x 54	3	2	20	-	20,611	20,611	20,611	20,611	21,190	21,741	-	16,014	16,014	16,014
TFT-22860-P	228 x 60	3	2	20	-	23,059	23,059	23,059	23,059	23,669	24,249	-	17,893	17,893	17,893
TFT-24054-P	240 x 54	3	2	20	-	21,632	21,632	21,632	21,632	22,218	22,775	-	16,836	16,836	16,836
TFT-24060-P	240 x 60	3	2	20	-	24,222	24,222	24,222	24,222	24,839	25,426	-	18,826	18,826	18,826



# INSET LAMINATE TOP WITH HARDWOOD EDGE

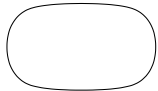

SOFT RECTANGLE TOP

**BASE KEY**

- OF Open Frame
- OFX Open Frame with X Center Base
- OFRP Open Frame with Painted Rectangle Center Base
- OFRV Open Frame with Veneer Rectangle Center Base
- RCL Laminate Racetrack Base
- RCP Painted Racetrack Base
- RCV Veneer Racetrack Base
- ML Post Metal Leg
- MLX Post Metal Leg with X Center Base
- MLRP Post Metal Leg with Painted Rectangle Center Base
- MLRV Post Metal Leg with Veneer Rectangle Center Base

**SOFT RECTANGLE TABLES**

MODEL #	L x W	BASE QTY	TOP SECTIONS	SEATING CAPACITY	-OF	-OFX	-OFRP	-OFRV	-RCL	-RCP	-RCV	-ML	-MLX	-MLRP	-MLRV
TFF-6030-P	60 x 30	2	1	4	3,582	-	-	-	-	-	-	2,676	-	-	-
TFF-6036-P	60 x 36	2	1	4	3,767	-	-	-	-	-	-	2,817	-	-	-
TFF-6042-P	60 x 42	2	1	4	4,297	-	-	-	-	-	-	3,215	-	-	-
TFF-6048-P	60 x 48	2	1	4	4,655	-	-	-	-	-	-	3,485	-	-	-
TFF-6630-P	66 x 30	2	1	4	3,904	-	-	-	-	-	-	2,923	-	-	-
TFF-6636-P	66 x 36	2	1	4	4,119	-	-	-	-	-	-	3,087	-	-	-
TFF-6642-P	66 x 42	2	1	4	4,712	-	-	-	-	-	-	3,535	-	-	-
TFF-6648-P	66 x 48	2	1	4	5,117	-	-	-	-	-	-	3,840	-	-	-
TFF-7230-P	72 x 30	2	1	6	4,026	-	-	-	-	-	-	3,024	-	-	-
TFF-7236-P	72 x 36	2	1	6	4,261	-	-	-	-	-	-	3,201	-	-	-
TFF-7242-P	72 x 42	2	1	6	4,888	-	-	-	4,888	5,131	5,361	3,675	-	-	-
TFF-7248-P	72 x 48	2	1	6	5,320	-	-	-	5,320	5,571	5,810	4,003	-	-	-
TFF-7830-P	78 x 30	2	1	6	4,436	-	-	-	-	-	-	3,338	-	-	-
TFF-7836-P	78 x 36	2	1	6	4,708	-	-	-	-	-	-	3,544	-	-	-
TFF-7842-P	78 x 42	2	1	6	5,415	-	-	-	5,415	5,675	5,922	4,079	-	-	-
TFF-7848-P	78 x 48	2	1	6	5,908	-	-	-	5,908	6,176	6,431	4,452	-	-	-
TFF-8430-P	84 x 30	2	1	8	4,568	-	-	-	-	-	-	3,444	-	-	-
TFF-8436-P	84 x 36	2	1	8	4,860	-	-	-	-	-	-	3,666	-	-	-
TFF-8442-P	84 x 42	2	1	8	5,603	-	-	-	5,603	5,862	6,110	4,229	-	-	-
TFF-8448-P	84 x 48	2	1	8	6,125	-	-	-	6,125	6,393	6,650	4,625	-	-	-
TFF-9030-P	90 x 30	2	1	8	4,943	-	-	-	-	-	-	3,734	-	-	-
TFF-9036-P	90 x 36	2	1	8	5,273	-	-	-	-	-	-	3,986	-	-	-
TFF-9042-P	90 x 42	2	1	8	6,092	-	-	-	6,092	6,365	6,625	4,606	-	-	-
TFF-9048-P	90 x 48	2	1	8	6,672	-	-	-	6,672	6,955	7,223	5,047	-	-	-
TFF-9630-P	96 x 30	2	1	8	5,080	-	-	-	-	-	-	3,847	-	-	-
TFF-9636-P	96 x 36	2	1	8	5,431	-	-	-	-	-	-	4,114	-	-	-
TFF-9642-P	96 x 42	2	1	8	6,289	-	-	-	6,289	6,563	6,822	4,764	-	-	-
TFF-9648-P	96 x 48	2	1	8	6,901	-	-	-	6,901	7,183	7,452	5,228	-	-	-
TFF-10242-P	102 x 42	2	1	8	6,846	-	-	-	6,846	7,134	7,408	5,195	-	-	-
TFF-10248-P	102 x 48	2	1	8	7,526	-	-	-	7,526	7,824	8,108	5,711	-	-	-
TFF-10842-P	108 x 42	2	1	10	7,055	-	-	-	7,055	7,343	7,617	5,361	-	-	-
TFF-10848-P	108 x 48	2	1	10	7,768	-	-	-	7,768	8,066	8,350	5,902	-	-	-
TFF-10854-P	108 x 54	2	1	10	8,604	-	-	-	8,604	8,915	9,211	6,538	-	-	-
TFF-11442-P	114 x 42	2	1	10	7,646	-	-	-	7,646	7,950	8,238	5,818	-	-	-
TFF-11448-P	114 x 48	2	1	10	8,431	-	-	-	8,431	8,745	9,043	6,415	-	-	-
TFF-11454-P	114 x 54	2	1	12	9,350	-	-	-	9,350	9,678	9,990	7,114	-	-	-
TFF-12042-P	120 x 42	2	1	10	7,865	-	-	-	7,865	8,168	8,457	5,993	-	-	-
TFF-12048-P	120 x 48	2	1	10	8,686	-	-	-	8,686	9,000	9,298	6,617	-	-	-
TFF-12054-P	120 x 54	2	1	12	9,645	-	-	-	9,645	9,973	10,285	7,348	-	-	-
TFF-13242-P	132 x 42	2	2	10	8,650	-	-	-	8,650	8,966	9,266	6,607	-	-	-
TFF-13248-P	132 x 48	2	2	10	9,577	-	-	-	9,577	9,904	10,215	7,314	-	-	-
TFF-13254-P	132 x 54	2	2	12	10,660	-	-	-	10,660	11,002	11,326	8,139	-	-	-
TFF-14448-P	144 x 48	2	2	12	10,512	-	-	-	10,512	10,852	11,175	8,043	-	-	-
TFF-14454-P	144 x 54	2	2	14	11,724	-	-	-	11,724	12,079	12,418	8,969	-	-	-
TFF-14460-P	144 x 60	2	2	14	13,133	-	-	-	13,133	13,507	13,864	10,042	-	-	-
TFF-15648-P	156 x 48	3	2	14	-	13,398	13,398	13,398	13,398	13,913	14,402	-	10,270	10,270	10,270
TFF-15654-P	156 x 54	3	2	14	-	14,808	14,808	14,808	14,808	15,346	15,858	-	11,346	11,346	11,346
TFF-15660-P	156 x 60	3	2	14	-	16,455	16,455	16,455	16,455	17,022	17,560	-	12,603	12,603	12,603
TFF-16854-P	168 x 54	3	2	16	-	15,533	15,533	15,533	15,533	16,070	16,582	-	11,936	11,936	11,936
TFF-16860-P	168 x 60	3	2	16	-	17,285	17,285	17,285	17,285	17,851	18,390	-	13,274	13,274	13,274
TFF-18054-P	180 x 54	3	2	16	-	16,256	16,256	16,256	16,256	16,795	17,306	-	12,525	12,525	12,525
TFF-18060-P	180 x 60	3	2	16	-	18,112	18,112	18,112	18,112	18,679	19,218	-	13,944	13,944	13,944
TFF-19254-P	192 x 54	3	2	18	-	16,981	16,981	16,981	16,981	17,519	18,031	-	13,113	13,113	13,113
TFF-19260-P	192 x 60	3	2	18	-	18,942	18,942	18,942	18,942	19,508	20,048	-	14,615	14,615	14,615
TFF-20454-P	204 x 54	3	2	18	-	18,423	18,423	18,423	18,423	18,984	19,516	-	14,259	14,259	14,259
TFF-20460-P	204 x 60	3	2	18	-	20,573	20,573	20,573	20,573	21,163	21,724	-	15,907	15,907	15,907
TFF-21654-P	216 x 54	3	2	20	-	19,644	19,644	19,644	19,644	20,218	20,764	-	15,235	15,235	15,235
TFF-21660-P	216 x 60	3	2	20	-	21,958	21,958	21,958	21,958	22,562	23,137	-	17,010	17,010	17,010
TFF-22854-P	228 x 54	3	2	20	-	20,611	20,611	20,611	20,611	21,190	21,741	-	16,014	16,014	16,014
TFF-22860-P	228 x 60	3	2	20	-	23,059	23,059	23,059	23,059	23,669	24,249	-	17,893	17,893	17,893
TFF-24054-P	240 x 54	3	2	20	-	21,632	21,632	21,632	21,632	22,218	22,775	-	16,836	16,836	16,836
TFF-24060-P	240 x 60	3	2	20	-	24,222	24,222	24,222	24,222	24,839	25,426	-	18,826	18,826	18,826



# INSET LAMINATE TOP WITH HARDWOOD EDGE

OPTIONS	CODE	PRICE	NOTES
Power & Data Options			See pages 123-133
<b>Polished Chrome Finish Options:</b>			
Polished Chrome Open Frame Base	Add -PCOF-TWB	\$2,169	
Polished Chrome Post Metal Legs	Add -PCML-TWB	\$1,164	
Polished Chrome Open Frame with X-Center Base	Add -PCOFX-TWB	\$3,252	
Polished Chrome Post Metal Legs with X-Center Base	Add -PCMLX-TWB	\$2,247	
<b>Multi-Section Tops:</b>			
102", 108", 114" and 120" one-piece tops split into two sections	Specify -2	\$764	Note: Power Matrix (center of table location only) cannot be specified when this option is selected
204", 216", 228" or 240" two-piece tops split into four sections	Specify -4	\$1,524	

## EDGE PROFILE

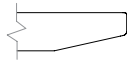

Two4Six Cutback Edge

## GENERAL INFORMATION

- Tops are 1-1/8"-thick
- Seating capacity based on 27" per person
- Overall table height 29.5"
- Standard with quarter cut veneer
- One section of wire management channel provided per table with Post Metal Leg and Open Frame Square Bases
- Racetrack Bases have a removable access door

### REQUIRED INFORMATION (ORDER CANNOT BE ENTERED WITHOUT THIS INFORMATION)

See appendix pages vi-vii for surface material options.

- Choose Laminate Finish
- Choose Wood Species & Finish for Hardwood Edge
- Choose Metal Finish only if -OF or -ML bases specified (Clear Anodized (-CA) is an option on the Post Metal Leg only)
- Choose Beam Metal Finish for tables 102"-240"L, with a Racetrack Base (-RCL, -RCP, -RCV)



# LAMINATE TOP WITH ABS CUTBACK EDGE



RECTANGLE TOP

**BASE KEY**

- OF Open Frame
- OFX Open Frame with X Center Base
- OFRP Open Frame with Painted Rectangle Center Base
- OFRV Open Frame with Veneer Rectangle Center Base
- RCL Laminate Racetrack Base
- RCP Painted Racetrack Base
- RCV Veneer Racetrack Base
- ML Post Metal Leg
- MLX Post Metal Leg with X Center Base
- MLRP Post Metal Leg with Painted Rectangle Center Base
- MLRV Post Metal Leg with Veneer Rectangle Center Base

**RECTANGLE TABLES**

MODEL #	L x W	BASE QTY	TOP SECTIONS	SEATING CAPACITY	-OF	-OFX	-OFRP	-OFRV	-RCL	-RCP	-RCV	-ML	-MLX	-MLRP	-MLRV
TFT-6030-PA	60 x 30	2	1	4	3,582	-	-	-	-	-	-	2,676	-	-	-
TFT-6036-PA	60 x 36	2	1	4	3,767	-	-	-	-	-	-	2,817	-	-	-
TFT-6042-PA	60 x 42	2	1	4	4,297	-	-	-	-	-	-	3,215	-	-	-
TFT-6048-PA	60 x 48	2	1	4	4,655	-	-	-	-	-	-	3,485	-	-	-
TFT-6630-PA	66 x 30	2	1	4	3,904	-	-	-	-	-	-	2,923	-	-	-
TFT-6636-PA	66 x 36	2	1	4	4,119	-	-	-	-	-	-	3,087	-	-	-
TFT-6642-PA	66 x 42	2	1	4	4,712	-	-	-	-	-	-	3,535	-	-	-
TFT-6648-PA	66 x 48	2	1	4	5,117	-	-	-	-	-	-	3,840	-	-	-
TFT-7230-PA	72 x 30	2	1	6	4,026	-	-	-	-	-	-	3,024	-	-	-
TFT-7236-PA	72 x 36	2	1	6	4,261	-	-	-	-	-	-	3,201	-	-	-
TFT-7242-PA	72 x 42	2	1	6	4,888	-	-	-	4,888	5,131	5,361	3,675	-	-	-
TFT-7248-PA	72 x 48	2	1	6	5,320	-	-	-	5,320	5,571	5,810	4,003	-	-	-
TFT-7830-PA	78 x 30	2	1	6	4,436	-	-	-	-	-	-	3,338	-	-	-
TFT-7836-PA	78 x 36	2	1	6	4,708	-	-	-	-	-	-	3,544	-	-	-
TFT-7842-PA	78 x 42	2	1	6	5,415	-	-	-	5,415	5,675	5,922	4,079	-	-	-
TFT-7848-PA	78 x 48	2	1	6	5,908	-	-	-	5,908	6,176	6,431	4,452	-	-	-
TFT-8430-PA	84 x 30	2	1	8	4,568	-	-	-	-	-	-	3,444	-	-	-
TFT-8436-PA	84 x 36	2	1	8	4,860	-	-	-	-	-	-	3,666	-	-	-
TFT-8442-PA	84 x 42	2	1	8	5,603	-	-	-	5,603	5,862	6,110	4,229	-	-	-
TFT-8448-PA	84 x 48	2	1	8	6,125	-	-	-	6,125	6,393	6,650	4,625	-	-	-
TFT-9030-PA	90 x 30	2	1	8	4,943	-	-	-	-	-	-	3,734	-	-	-
TFT-9036-PA	90 x 36	2	1	8	5,273	-	-	-	-	-	-	3,986	-	-	-
TFT-9042-PA	90 x 42	2	1	8	6,092	-	-	-	6,092	6,365	6,625	4,606	-	-	-
TFT-9048-PA	90 x 48	2	1	8	6,672	-	-	-	6,672	6,955	7,223	5,047	-	-	-
TFT-9630-PA	96 x 30	2	1	8	5,080	-	-	-	-	-	-	3,847	-	-	-
TFT-9636-PA	96 x 36	2	1	8	5,431	-	-	-	-	-	-	4,114	-	-	-
TFT-9642-PA	96 x 42	2	1	8	6,289	-	-	-	6,289	6,563	6,822	4,764	-	-	-
TFT-9648-PA	96 x 48	2	1	8	6,901	-	-	-	6,901	7,183	7,452	5,228	-	-	-
TFT-10242-PA	102 x 42	2	1	8	6,846	-	-	-	6,846	7,134	7,408	5,195	-	-	-
TFT-10248-PA	102 x 48	2	1	8	7,526	-	-	-	7,526	7,824	8,108	5,711	-	-	-
TFT-10842-PA	108 x 42	2	1	10	7,055	-	-	-	7,055	7,343	7,617	5,361	-	-	-
TFT-10848-PA	108 x 48	2	1	10	7,768	-	-	-	7,768	8,066	8,350	5,902	-	-	-
TFT-10854-PA	108 x 54	2	1	10	8,604	-	-	-	8,604	8,915	9,211	6,538	-	-	-
TFT-11442-PA	114 x 42	2	1	10	7,646	-	-	-	7,646	7,950	8,238	5,818	-	-	-
TFT-11448-PA	114 x 48	2	1	10	8,431	-	-	-	8,431	8,745	9,043	6,415	-	-	-
TFT-11454-PA	114 x 54	2	1	12	9,350	-	-	-	9,350	9,678	9,990	7,114	-	-	-
TFT-12042-PA	120 x 42	2	1	10	7,865	-	-	-	7,865	8,168	8,457	5,993	-	-	-
TFT-12048-PA	120 x 48	2	1	10	8,686	-	-	-	8,686	9,000	9,298	6,617	-	-	-
TFT-12054-PA	120 x 54	2	1	12	9,645	-	-	-	9,645	9,973	10,285	7,348	-	-	-
TFT-13242-PA	132 x 42	2	2	10	8,650	-	-	-	8,650	8,966	9,266	6,607	-	-	-
TFT-13248-PA	132 x 48	2	2	10	9,577	-	-	-	9,577	9,904	10,215	7,314	-	-	-
TFT-13254-PA	132 x 54	2	2	12	10,660	-	-	-	10,660	11,002	11,326	8,139	-	-	-
TFT-14448-PA	144 x 48	2	2	12	10,512	-	-	-	10,512	10,852	11,175	8,043	-	-	-
TFT-14454-PA	144 x 54	2	2	14	11,724	-	-	-	11,724	12,079	12,418	8,969	-	-	-
TFT-14460-PA	144 x 60	2	2	14	13,133	-	-	-	13,133	13,507	13,864	10,042	-	-	-
TFT-15648-PA	156 x 48	3	2	14	-	13,398	13,398	13,398	13,398	13,913	14,402	-	10,270	10,270	10,270
TFT-15654-PA	156 x 54	3	2	14	-	14,808	14,808	14,808	14,808	15,346	15,858	-	11,346	11,346	11,346
TFT-15660-PA	156 x 60	3	2	14	-	16,455	16,455	16,455	16,455	17,022	17,560	-	12,603	12,603	12,603
TFT-16854-PA	168 x 54	3	2	16	-	15,533	15,533	15,533	15,533	16,070	16,582	-	11,936	11,936	11,936
TFT-16860-PA	168 x 60	3	2	16	-	17,285	17,285	17,285	17,285	17,851	18,390	-	13,274	13,274	13,274
TFT-18054-PA	180 x 54	3	2	16	-	16,256	16,256	16,256	16,256	16,795	17,306	-	12,525	12,525	12,525
TFT-18060-PA	180 x 60	3	2	16	-	18,112	18,112	18,112	18,112	18,679	19,218	-	13,944	13,944	13,944
TFT-19254-PA	192 x 54	3	2	18	-	16,981	16,981	16,981	16,981	17,519	18,031	-	13,113	13,113	13,113
TFT-19260-PA	192 x 60	3	2	18	-	18,942	18,942	18,942	18,942	19,508	20,048	-	14,615	14,615	14,615
TFT-20454-PA	204 x 54	3	2	18	-	18,423	18,423	18,423	18,423	18,984	19,516	-	14,259	14,259	14,259
TFT-20460-PA	204 x 60	3	2	18	-	20,573	20,573	20,573	20,573	21,163	21,724	-	15,907	15,907	15,907
TFT-21654-PA	216 x 54	3	2	20	-	19,644	19,644	19,644	19,644	20,218	20,764	-	15,235	15,235	15,235
TFT-21660-PA	216 x 60	3	2	20	-	21,958	21,958	21,958	21,958	22,562	23,137	-	17,010	17,010	17,010
TFT-22854-PA	228 x 54	3	2	20	-	20,611	20,611	20,611	20,611	21,190	21,741	-	16,014	16,014	16,014
TFT-22860-PA	228 x 60	3	2	20	-	23,059	23,059	23,059	23,059	23,669	24,249	-	17,893	17,893	17,893
TFT-24054-PA	240 x 54	3	2	20	-	21,632	21,632	21,632	21,632	22,218	22,775	-	16,836	16,836	16,836
TFT-24060-PA	240 x 60	3	2	20	-	24,222	24,222	24,222	24,222	24,839	25,426	-	18,826	18,826	18,826



# LAMINATE TOP WITH ABS CUTBACK EDGE

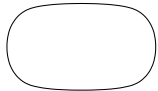

SOFT RECTANGLE TOP

**BASE KEY**

- OF Open Frame
- OFX Open Frame with X Center Base
- OFRP Open Frame with Painted Rectangle Center Base
- OFRV Open Frame with Veneer Rectangle Center Base
- RCL Laminate Racetrack Base
- RCP Painted Racetrack Base
- RCV Veneer Racetrack Base
- ML Post Metal Leg
- MLX Post Metal Leg with X Center Base
- MLRP Post Metal Leg with Painted Rectangle Center Base
- MLRV Post Metal Leg with Veneer Rectangle Center Base

**SOFT RECTANGLE TABLES**

MODEL #	L x W	BASE QTY	TOP SECTIONS	SEATING CAPACITY	-OF	-OFX	-OFRP	-OFRV	-RCL	-RCP	-RCV	-ML	-MLX	-MLRP	-MLRV
TFF-6030-PA	60 x 30	2	1	4	3,582	-	-	-	-	-	-	2,676	-	-	-
TFF-6036-PA	60 x 36	2	1	4	3,767	-	-	-	-	-	-	2,817	-	-	-
TFF-6042-PA	60 x 42	2	1	4	4,297	-	-	-	-	-	-	3,215	-	-	-
TFF-6048-PA	60 x 48	2	1	4	4,655	-	-	-	-	-	-	3,485	-	-	-
TFF-6630-PA	66 x 30	2	1	4	3,904	-	-	-	-	-	-	2,923	-	-	-
TFF-6636-PA	66 x 36	2	1	4	4,119	-	-	-	-	-	-	3,087	-	-	-
TFF-6642-PA	66 x 42	2	1	4	4,712	-	-	-	-	-	-	3,535	-	-	-
TFF-6648-PA	66 x 48	2	1	4	5,117	-	-	-	-	-	-	3,840	-	-	-
TFF-7230-PA	72 x 30	2	1	6	4,026	-	-	-	-	-	-	3,024	-	-	-
TFF-7236-PA	72 x 36	2	1	6	4,261	-	-	-	-	-	-	3,201	-	-	-
TFF-7242-PA	72 x 42	2	1	6	4,888	-	-	-	4,888	5,131	5,361	3,675	-	-	-
TFF-7248-PA	72 x 48	2	1	6	5,320	-	-	-	5,320	5,571	5,810	4,003	-	-	-
TFF-7830-PA	78 x 30	2	1	6	4,436	-	-	-	-	-	-	3,338	-	-	-
TFF-7836-PA	78 x 36	2	1	6	4,708	-	-	-	-	-	-	3,544	-	-	-
TFF-7842-PA	78 x 42	2	1	6	5,415	-	-	-	5,415	5,675	5,922	4,079	-	-	-
TFF-7848-PA	78 x 48	2	1	6	5,908	-	-	-	5,908	6,176	6,431	4,452	-	-	-
TFF-8430-PA	84 x 30	2	1	8	4,568	-	-	-	-	-	-	3,444	-	-	-
TFF-8436-PA	84 x 36	2	1	8	4,860	-	-	-	-	-	-	3,666	-	-	-
TFF-8442-PA	84 x 42	2	1	8	5,603	-	-	-	5,603	5,862	6,110	4,229	-	-	-
TFF-8448-PA	84 x 48	2	1	8	6,125	-	-	-	6,125	6,393	6,650	4,625	-	-	-
TFF-9030-PA	90 x 30	2	1	8	4,943	-	-	-	-	-	-	3,734	-	-	-
TFF-9036-PA	90 x 36	2	1	8	5,273	-	-	-	-	-	-	3,986	-	-	-
TFF-9042-PA	90 x 42	2	1	8	6,092	-	-	-	6,092	6,365	6,625	4,606	-	-	-
TFF-9048-PA	90 x 48	2	1	8	6,672	-	-	-	6,672	6,955	7,223	5,047	-	-	-
TFF-9630-PA	96 x 30	2	1	8	5,080	-	-	-	-	-	-	3,847	-	-	-
TFF-9636-PA	96 x 36	2	1	8	5,431	-	-	-	-	-	-	4,114	-	-	-
TFF-9642-PA	96 x 42	2	1	8	6,289	-	-	-	6,289	6,563	6,822	4,764	-	-	-
TFF-9648-PA	96 x 48	2	1	8	6,901	-	-	-	6,901	7,183	7,452	5,228	-	-	-
TFF-10242-PA	102 x 42	2	1	8	6,846	-	-	-	6,846	7,134	7,408	5,195	-	-	-
TFF-10248-PA	102 x 48	2	1	8	7,526	-	-	-	7,526	7,824	8,108	5,711	-	-	-
TFF-10842-PA	108 x 42	2	1	10	7,055	-	-	-	7,055	7,343	7,617	5,361	-	-	-
TFF-10848-PA	108 x 48	2	1	10	7,768	-	-	-	7,768	8,066	8,350	5,902	-	-	-
TFF-10854-PA	108 x 54	2	1	10	8,604	-	-	-	8,604	8,915	9,211	6,538	-	-	-
TFF-11442-PA	114 x 42	2	1	10	7,646	-	-	-	7,646	7,950	8,238	5,818	-	-	-
TFF-11448-PA	114 x 48	2	1	10	8,431	-	-	-	8,431	8,745	9,043	6,415	-	-	-
TFF-11454-PA	114 x 54	2	1	12	9,350	-	-	-	9,350	9,678	9,990	7,114	-	-	-
TFF-12042-PA	120 x 42	2	1	10	7,865	-	-	-	7,865	8,168	8,457	5,993	-	-	-
TFF-12048-PA	120 x 48	2	1	10	8,686	-	-	-	8,686	9,000	9,298	6,617	-	-	-
TFF-12054-PA	120 x 54	2	1	12	9,645	-	-	-	9,645	9,973	10,285	7,348	-	-	-
TFF-13242-PA	132 x 42	2	2	10	8,650	-	-	-	8,650	8,966	9,266	6,607	-	-	-
TFF-13248-PA	132 x 48	2	2	10	9,577	-	-	-	9,577	9,904	10,215	7,314	-	-	-
TFF-13254-PA	132 x 54	2	2	12	10,660	-	-	-	10,660	11,002	11,326	8,139	-	-	-
TFF-14448-PA	144 x 48	2	2	12	10,512	-	-	-	10,512	10,852	11,175	8,043	-	-	-
TFF-14454-PA	144 x 54	2	2	14	11,724	-	-	-	11,724	12,079	12,418	8,969	-	-	-
TFF-14460-PA	144 x 60	2	2	14	13,133	-	-	-	13,133	13,507	13,864	10,042	-	-	-
TFF-15648-PA	156 x 48	3	2	14	-	13,398	13,398	13,398	13,398	13,913	14,402	-	10,270	10,270	10,270
TFF-15654-PA	156 x 54	3	2	14	-	14,808	14,808	14,808	14,808	15,346	15,858	-	11,346	11,346	11,346
TFF-15660-PA	156 x 60	3	2	14	-	16,455	16,455	16,455	16,455	17,022	17,560	-	12,603	12,603	12,603
TFF-16854-PA	168 x 54	3	2	16	-	15,533	15,533	15,533	15,533	16,070	16,582	-	11,936	11,936	11,936
TFF-16860-PA	168 x 60	3	2	16	-	17,285	17,285	17,285	17,285	17,851	18,390	-	13,274	13,274	13,274
TFF-18054-PA	180 x 54	3	2	16	-	16,256	16,256	16,256	16,256	16,795	17,306	-	12,525	12,525	12,525
TFF-18060-PA	180 x 60	3	2	16	-	18,112	18,112	18,112	18,112	18,679	19,218	-	13,944	13,944	13,944
TFF-19254-PA	192 x 54	3	2	18	-	16,981	16,981	16,981	16,981	17,519	18,031	-	13,113	13,113	13,113
TFF-19260-PA	192 x 60	3	2	18	-	18,942	18,942	18,942	18,942	19,508	20,048	-	14,615	14,615	14,615
TFF-20454-PA	204 x 54	3	2	18	-	18,423	18,423	18,423	18,423	18,984	19,516	-	14,259	14,259	14,259
TFF-20460-PA	204 x 60	3	2	18	-	20,573	20,573	20,573	20,573	21,163	21,724	-	15,907	15,907	15,907
TFF-21654-PA	216 x 54	3	2	20	-	19,644	19,644	19,644	19,644	20,218	20,764	-	15,235	15,235	15,235
TFF-21660-PA	216 x 60	3	2	20	-	21,958	21,958	21,958	21,958	22,562	23,137	-	17,010	17,010	17,010
TFF-22854-PA	228 x 54	3	2	20	-	20,611	20,611	20,611	20,611	21,190	21,741	-	16,014	16,014	16,014
TFF-22860-PA	228 x 60	3	2	20	-	23,059	23,059	23,059	23,059	23,669	24,249	-	17,893	17,893	17,893
TFF-24054-PA	240 x 54	3	2	20	-	21,632	21,632	21,632	21,632	22,218	22,775	-	16,836	16,836	16,836
TFF-24060-PA	240 x 60	3	2	20	-	24,222	24,222	24,222	24,222	24,839	25,426	-	18,826	18,826	18,826



# LAMINATE TOP WITH ABS CUTBACK EDGE

OPTIONS	CODE	PRICE	NOTES
Power & Data Options			See pages 123-133
<b>Polished Chrome Finish Options:</b>			
Polished Chrome Open Frame Base	Add - <b>PCOF-TWB</b>	\$2,169	
Polished Chrome Post Metal Legs	Add - <b>PCML-TWB</b>	\$1,164	
Polished Chrome Open Frame with X-Center Base	Add - <b>PCOFX-TWB</b>	\$3,252	
Polished Chrome Post Metal Legs with X-Center Base	Add - <b>PCMLX-TWB</b>	\$2,247	
<b>Multi-Section Tops:</b>			
102", 108", 114" and 120" one-piece tops split into two sections	Specify -2	\$764	Note: Power Matrix (center of table location only) cannot be specified when this option is selected
204", 216", 228" or 240" two-piece tops split into four sections	Specify -4	\$1,524	

## EDGE PROFILE

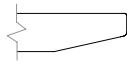

Two4Six Cutback Edge

## GENERAL INFORMATION

- Tops are 1-1/8"-thick
- Seating capacity based on 27" per person
- Overall table height 29.5"
- Standard with quarter cut veneer
- One section of wire management channel provided per table with Post Metal Leg and Open Frame Square Bases
- Racetrack Bases have a removable access door

### REQUIRED INFORMATION (ORDER CANNOT BE ENTERED WITHOUT THIS INFORMATION)

See appendix pages vi-vii for surface material options.

- Choose Laminate Finish
- Choose ABS Edge Finish
- Choose Metal Finish only if -OF or -ML bases specified (Clear Anodized (-CA) is an option on the Post Metal Leg only)
- Choose Beam Metal Finish for tables 102"-240"L, with a Racetrack Base (-RCL, -RCP, -RCV)





# LAMINATE TOP WITH ABS SQUARE EDGE



RECTANGLE TOP

**BASE KEY**

- OF Open Frame
- OFX Open Frame with X Center Base
- OFRP Open Frame with Painted Rectangle Center Base
- OFRV Open Frame with Veneer Rectangle Center Base
- RCL Laminate Racetrack Base
- RCP Painted Racetrack Base
- RCV Veneer Racetrack Base
- ML Post Metal Leg
- MLX Post Metal Leg with X Center Base
- MLRP Post Metal Leg with Painted Rectangle Center Base
- MLRV Post Metal Leg with Veneer Rectangle Center Base

**RECTANGLE TABLES**

MODEL #	L x W	BASE QTY	TOP SECTIONS	SEATING CAPACITY	-OF	-OFX	-OFRP	-OFRV	-RCL	-RCP	-RCV	-ML	-MLX	-MLRP	-MLRV
TFT-6030-PE	60 x 30	2	1	4	3,222	-	-	-	-	-	-	1,965	-	-	-
TFT-6036-PE	60 x 36	2	1	4	3,389	-	-	-	-	-	-	2,069	-	-	-
TFT-6042-PE	60 x 42	2	1	4	3,865	-	-	-	-	-	-	2,361	-	-	-
TFT-6048-PE	60 x 48	2	1	4	4,187	-	-	-	-	-	-	2,559	-	-	-
TFT-6630-PE	66 x 30	2	1	4	3,512	-	-	-	-	-	-	2,147	-	-	-
TFT-6636-PE	66 x 36	2	1	4	3,705	-	-	-	-	-	-	2,267	-	-	-
TFT-6642-PE	66 x 42	2	1	4	4,239	-	-	-	-	-	-	2,596	-	-	-
TFT-6648-PE	66 x 48	2	1	4	4,602	-	-	-	-	-	-	2,820	-	-	-
TFT-7230-PE	72 x 30	2	1	6	3,621	-	-	-	-	-	-	2,221	-	-	-
TFT-7236-PE	72 x 36	2	1	6	3,832	-	-	-	-	-	-	2,351	-	-	-
TFT-7242-PE	72 x 42	2	1	6	4,397	-	-	-	4,397	4,615	4,823	2,699	-	-	-
TFT-7248-PE	72 x 48	2	1	6	4,785	-	-	-	4,785	5,011	5,226	2,940	-	-	-
TFT-7830-PE	78 x 30	2	1	6	3,990	-	-	-	-	-	-	2,452	-	-	-
TFT-7836-PE	78 x 36	2	1	6	4,234	-	-	-	-	-	-	2,603	-	-	-
TFT-7842-PE	78 x 42	2	1	6	4,871	-	-	-	4,871	5,105	5,327	2,996	-	-	-
TFT-7848-PE	78 x 48	2	1	6	5,314	-	-	-	5,314	5,555	5,785	3,270	-	-	-
TFT-8430-PE	84 x 30	2	1	8	4,109	-	-	-	-	-	-	2,529	-	-	-
TFT-8436-PE	84 x 36	2	1	8	4,371	-	-	-	-	-	-	2,693	-	-	-
TFT-8442-PE	84 x 42	2	1	8	5,040	-	-	-	5,040	5,273	5,496	3,106	-	-	-
TFT-8448-PE	84 x 48	2	1	8	5,509	-	-	-	5,509	5,751	5,981	3,397	-	-	-
TFT-9030-PE	90 x 30	2	1	8	4,446	-	-	-	-	-	-	2,742	-	-	-
TFT-9036-PE	90 x 36	2	1	8	4,743	-	-	-	-	-	-	2,927	-	-	-
TFT-9042-PE	90 x 42	2	1	8	5,480	-	-	-	5,480	5,725	5,959	3,383	-	-	-
TFT-9048-PE	90 x 48	2	1	8	6,001	-	-	-	6,001	6,256	6,497	3,706	-	-	-
TFT-9630-PE	96 x 30	2	1	8	4,569	-	-	-	-	-	-	2,825	-	-	-
TFT-9636-PE	96 x 36	2	1	8	4,885	-	-	-	-	-	-	3,021	-	-	-
TFT-9642-PE	96 x 42	2	1	8	5,657	-	-	-	5,657	5,903	6,137	3,499	-	-	-
TFT-9648-PE	96 x 48	2	1	8	6,207	-	-	-	6,207	6,461	6,703	3,840	-	-	-
TFT-10242-PE	102 x 42	2	1	8	6,158	-	-	-	6,158	6,417	6,664	3,815	-	-	-
TFT-10248-PE	102 x 48	2	1	8	6,770	-	-	-	6,770	7,038	7,293	4,194	-	-	-
TFT-10842-PE	108 x 42	2	1	10	6,346	-	-	-	6,346	6,605	6,851	3,938	-	-	-
TFT-10848-PE	108 x 48	2	1	10	6,987	-	-	-	6,987	7,255	7,510	4,335	-	-	-
TFT-10854-PE	108 x 54	2	1	10	7,739	-	-	-	7,739	8,019	8,285	5,881	-	-	-
TFT-11442-PE	114 x 42	2	1	10	6,878	-	-	-	6,878	7,151	7,410	4,273	-	-	-
TFT-11448-PE	114 x 48	2	1	10	7,583	-	-	-	7,583	7,866	8,134	4,711	-	-	-
TFT-11454-PE	114 x 54	2	1	12	8,410	-	-	-	8,410	8,705	8,986	5,225	-	-	-
TFT-12042-PE	120 x 42	2	1	10	7,074	-	-	-	7,074	7,347	7,607	4,401	-	-	-
TFT-12048-PE	120 x 48	2	1	10	7,813	-	-	-	7,813	8,095	8,364	4,860	-	-	-
TFT-12054-PE	120 x 54	2	1	12	8,676	-	-	-	8,676	8,971	9,251	5,396	-	-	-
TFT-13242-PE	132 x 42	2	2	10	7,781	-	-	-	7,781	8,064	8,335	4,852	-	-	-
TFT-13248-PE	132 x 48	2	2	10	8,614	-	-	-	8,614	8,908	9,188	5,371	-	-	-
TFT-13254-PE	132 x 54	2	2	12	9,588	-	-	-	9,588	9,896	10,188	5,977	-	-	-
TFT-14448-PE	144 x 48	2	2	12	9,455	-	-	-	9,455	9,761	10,052	5,907	-	-	-
TFT-14454-PE	144 x 54	2	2	14	10,546	-	-	-	10,546	10,865	11,169	6,587	-	-	-
TFT-14460-PE	144 x 60	2	2	14	11,813	-	-	-	11,813	12,150	12,470	7,375	-	-	-
TFT-15648-PE	156 x 48	3	2	14	-	12,051	12,051	12,051	12,051	12,514	12,954	-	7,542	7,542	7,542
TFT-15654-PE	156 x 54	3	2	14	-	13,319	13,319	13,319	13,319	13,804	14,263	-	8,333	8,333	8,333
TFT-15660-PE	156 x 60	3	2	14	-	14,801	14,801	14,801	14,801	15,311	15,795	-	9,256	9,256	9,256
TFT-16854-PE	168 x 54	3	2	16	-	13,971	13,971	13,971	13,971	14,455	14,915	-	8,766	8,766	8,766
TFT-16860-PE	168 x 60	3	2	16	-	15,547	15,547	15,547	15,547	16,056	16,541	-	9,748	9,748	9,748
TFT-18054-PE	180 x 54	3	2	16	-	14,622	14,622	14,622	14,622	15,107	15,567	-	9,198	9,198	9,198
TFT-18060-PE	180 x 60	3	2	16	-	16,292	16,292	16,292	16,292	16,802	17,286	-	10,240	10,240	10,240
TFT-19254-PE	192 x 54	3	2	18	-	15,274	15,274	15,274	15,274	15,758	16,218	-	9,630	9,630	9,630
TFT-19260-PE	192 x 60	3	2	18	-	17,038	17,038	17,038	17,038	17,547	18,032	-	10,733	10,733	10,733
TFT-20454-PE	204 x 54	3	2	18	-	16,571	16,571	16,571	16,571	17,075	17,554	-	10,472	10,472	10,472
TFT-20460-PE	204 x 60	3	2	18	-	18,505	18,505	18,505	18,505	19,035	19,540	-	11,682	11,682	11,682
TFT-21654-PE	216 x 54	3	2	20	-	17,669	17,669	17,669	17,669	18,185	18,677	-	11,188	11,188	11,188
TFT-21660-PE	216 x 60	3	2	20	-	19,750	19,750	19,750	19,750	20,294	20,811	-	12,492	12,492	12,492
TFT-22854-PE	228 x 54	3	2	20	-	18,539	18,539	18,539	18,539	19,060	19,556	-	11,760	11,760	11,760
TFT-22860-PE	228 x 60	3	2	20	-	20,741	20,741	20,741	20,741	21,290	21,811	-	13,141	13,141	13,141
TFT-24054-PE	240 x 54	3	2	20	-	19,458	19,458	19,458	19,458	19,985	20,485	-	12,364	12,364	12,364
TFT-24060-PE	240 x 60	3	2	20	-	21,787	21,787	21,787	21,787	22,342	22,870	-	13,826	13,826	13,826



# LAMINATE TOP WITH ABS SQUARE EDGE

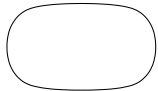

SOFT RECTANGLE TOP

**BASE KEY**

- OF Open Frame
- OFX Open Frame with X Center Base
- OFRP Open Frame with Painted Rectangle Center Base
- OFRV Open Frame with Veneer Rectangle Center Base
- RCL Laminate Racetrack Base
- RCP Painted Racetrack Base
- RCV Veneer Racetrack Base
- ML Post Metal Leg
- MLX Post Metal Leg with X Center Base
- MLRP Post Metal Leg with Painted Rectangle Center Base
- MLRV Post Metal Leg with Veneer Rectangle Center Base

**SOFT RECTANGLE TABLES**

MODEL #	L x W	BASE QTY	TOP SECTIONS	SEATING CAPACITY	-OF	-OFX	-OFRP	-OFRV	-RCL	-RCP	-RCV	-ML	-MLX	-MLRP	-MLRV
TFF-6030-PE	60 x 30	2	1	4	3,222	-	-	-	-	-	-	1,965	-	-	-
TFF-6036-PE	60 x 36	2	1	4	3,389	-	-	-	-	-	-	2,069	-	-	-
TFF-6042-PE	60 x 42	2	1	4	3,865	-	-	-	-	-	-	2,361	-	-	-
TFF-6048-PE	60 x 48	2	1	4	4,187	-	-	-	-	-	-	2,559	-	-	-
TFF-6630-PE	66 x 30	2	1	4	3,512	-	-	-	-	-	-	2,147	-	-	-
TFF-6636-PE	66 x 36	2	1	4	3,705	-	-	-	-	-	-	2,267	-	-	-
TFF-6642-PE	66 x 42	2	1	4	4,239	-	-	-	-	-	-	2,596	-	-	-
TFF-6648-PE	66 x 48	2	1	4	4,602	-	-	-	-	-	-	2,820	-	-	-
TFF-7230-PE	72 x 30	2	1	6	3,621	-	-	-	-	-	-	2,221	-	-	-
TFF-7236-PE	72 x 36	2	1	6	3,832	-	-	-	-	-	-	2,351	-	-	-
TFF-7242-PE	72 x 42	2	1	6	4,397	-	-	-	4,397	4,615	4,823	2,699	-	-	-
TFF-7248-PE	72 x 48	2	1	6	4,785	-	-	-	4,785	5,011	5,226	2,940	-	-	-
TFF-7830-PE	78 x 30	2	1	6	3,990	-	-	-	-	-	-	2,452	-	-	-
TFF-7836-PE	78 x 36	2	1	6	4,234	-	-	-	-	-	-	2,603	-	-	-
TFF-7842-PE	78 x 42	2	1	6	4,871	-	-	-	4,871	5,105	5,327	2,996	-	-	-
TFF-7848-PE	78 x 48	2	1	6	5,314	-	-	-	5,314	5,555	5,785	3,270	-	-	-
TFF-8430-PE	84 x 30	2	1	8	4,109	-	-	-	-	-	-	2,529	-	-	-
TFF-8436-PE	84 x 36	2	1	8	4,371	-	-	-	-	-	-	2,693	-	-	-
TFF-8442-PE	84 x 42	2	1	8	5,040	-	-	-	5,040	5,273	5,496	3,106	-	-	-
TFF-8448-PE	84 x 48	2	1	8	5,509	-	-	-	5,509	5,751	5,981	3,397	-	-	-
TFF-9030-PE	90 x 30	2	1	8	4,446	-	-	-	-	-	-	2,742	-	-	-
TFF-9036-PE	90 x 36	2	1	8	4,743	-	-	-	-	-	-	2,927	-	-	-
TFF-9042-PE	90 x 42	2	1	8	5,480	-	-	-	5,480	5,725	5,959	3,383	-	-	-
TFF-9048-PE	90 x 48	2	1	8	6,001	-	-	-	6,001	6,256	6,497	3,706	-	-	-
TFF-9630-PE	96 x 30	2	1	8	4,569	-	-	-	-	-	-	2,825	-	-	-
TFF-9636-PE	96 x 36	2	1	8	4,885	-	-	-	-	-	-	3,021	-	-	-
TFF-9642-PE	96 x 42	2	1	8	5,657	-	-	-	5,657	5,903	6,137	3,499	-	-	-
TFF-9648-PE	96 x 48	2	1	8	6,207	-	-	-	6,207	6,461	6,703	3,840	-	-	-
TFF-10242-PE	102 x 42	2	1	8	6,158	-	-	-	6,158	6,417	6,664	3,815	-	-	-
TFF-10248-PE	102 x 48	2	1	8	6,770	-	-	-	6,770	7,038	7,293	4,194	-	-	-
TFF-10842-PE	108 x 42	2	1	10	6,346	-	-	-	6,346	6,605	6,851	3,938	-	-	-
TFF-10848-PE	108 x 48	2	1	10	6,987	-	-	-	6,987	7,255	7,510	4,335	-	-	-
TFF-10854-PE	108 x 54	2	1	10	7,739	-	-	-	7,739	8,019	8,285	5,881	-	-	-
TFF-11442-PE	114 x 42	2	1	10	6,878	-	-	-	6,878	7,151	7,410	4,273	-	-	-
TFF-11448-PE	114 x 48	2	1	10	7,583	-	-	-	7,583	7,866	8,134	4,711	-	-	-
TFF-11454-PE	114 x 54	2	1	12	8,410	-	-	-	8,410	8,705	8,986	5,225	-	-	-
TFF-12042-PE	120 x 42	2	1	10	7,074	-	-	-	7,074	7,347	7,607	4,401	-	-	-
TFF-12048-PE	120 x 48	2	1	10	7,813	-	-	-	7,813	8,095	8,364	4,860	-	-	-
TFF-12054-PE	120 x 54	2	1	12	8,676	-	-	-	8,676	8,971	9,251	5,396	-	-	-
TFF-13242-PE	132 x 42	2	2	10	7,781	-	-	-	7,781	8,064	8,335	4,852	-	-	-
TFF-13248-PE	132 x 48	2	2	10	8,614	-	-	-	8,614	8,908	9,188	5,371	-	-	-
TFF-13254-PE	132 x 54	2	2	12	9,588	-	-	-	9,588	9,896	10,188	5,977	-	-	-
TFF-14448-PE	144 x 48	2	2	12	9,455	-	-	-	9,455	9,761	10,052	5,907	-	-	-
TFF-14454-PE	144 x 54	2	2	14	10,546	-	-	-	10,546	10,865	11,169	6,587	-	-	-
TFF-14460-PE	144 x 60	2	2	14	11,813	-	-	-	11,813	12,150	12,470	7,375	-	-	-
TFF-15648-PE	156 x 48	3	2	14	-	12,051	12,051	12,051	12,051	12,514	12,954	-	7,542	7,542	7,542
TFF-15654-PE	156 x 54	3	2	14	-	13,319	13,319	13,319	13,319	13,804	14,263	-	8,333	8,333	8,333
TFF-15660-PE	156 x 60	3	2	14	-	14,801	14,801	14,801	14,801	15,311	15,795	-	9,256	9,256	9,256
TFF-16854-PE	168 x 54	3	2	16	-	13,971	13,971	13,971	13,971	14,455	14,915	-	8,766	8,766	8,766
TFF-16860-PE	168 x 60	3	2	16	-	15,547	15,547	15,547	15,547	16,056	16,541	-	9,748	9,748	9,748
TFF-18054-PE	180 x 54	3	2	16	-	14,622	14,622	14,622	14,622	15,107	15,567	-	9,198	9,198	9,198
TFF-18060-PE	180 x 60	3	2	16	-	16,292	16,292	16,292	16,292	16,802	17,286	-	10,240	10,240	10,240
TFF-19254-PE	192 x 54	3	2	18	-	15,274	15,274	15,274	15,274	15,758	16,218	-	9,630	9,630	9,630
TFF-19260-PE	192 x 60	3	2	18	-	17,038	17,038	17,038	17,038	17,547	18,032	-	10,733	10,733	10,733
TFF-20454-PE	204 x 54	3	2	18	-	16,571	16,571	16,571	16,571	17,075	17,554	-	10,472	10,472	10,472
TFF-20460-PE	204 x 60	3	2	18	-	18,505	18,505	18,505	18,505	19,035	19,540	-	11,682	11,682	11,682
TFF-21654-PE	216 x 54	3	2	20	-	17,669	17,669	17,669	17,669	18,185	18,677	-	11,188	11,188	11,188
TFF-21660-PE	216 x 60	3	2	20	-	19,750	19,750	19,750	19,750	20,294	20,811	-	12,492	12,492	12,492
TFF-22854-PE	228 x 54	3	2	20	-	18,539	18,539	18,539	18,539	19,060	19,556	-	11,760	11,760	11,760
TFF-22860-PE	228 x 60	3	2	20	-	20,741	20,741	20,741	20,741	21,290	21,811	-	13,141	13,141	13,141
TFF-24054-PE	240 x 54	3	2	20	-	19,458	19,458	19,458	19,458	19,985	20,485	-	12,364	12,364	12,364
TFF-24060-PE	240 x 60	3	2	20	-	21,787	21,787	21,787	21,787	22,342	22,870	-	13,826	13,826	13,826



# LAMINATE TOP WITH ABS SQUARE EDGE

OPTIONS	CODE	PRICE	NOTES
Power & Data Options			See pages 123-133
<b>Polished Chrome Finish Options:</b>			
Polished Chrome Open Frame Base	Add <b>-PCOF-TWB</b>	\$2,169	
Polished Chrome Post Metal Legs	Add <b>-PCML-TWB</b>	\$1,164	
Polished Chrome Open Frame with X-Center Base	Add <b>-PCOFX-TWB</b>	\$3,252	
Polished Chrome Post Metal Legs with X-Center Base	Add <b>-PCMLX-TWB</b>	\$2,247	
<b>Multi-Section Tops:</b>			
102", 108", 114" and 120" one-piece tops split into two sections	Specify -2	\$764	Note: Power Matrix (center of table location only) cannot be specified when this option is selected
204", 216", 228" or 240" two-piece tops split into four sections	Specify -4	\$1,524	

## EDGE PROFILE



Two4Six Square Edge

## GENERAL INFORMATION

- Tops are 1-1/8"-thick
- Seating capacity based on 27" per person
- Overall table height 29.5"
- Standard with quarter cut veneer
- One section of wire management channel provided per table with Post Metal Leg and Open Frame Square Bases
- Racetrack Bases have a removable access door

### REQUIRED INFORMATION (ORDER CANNOT BE ENTERED WITHOUT THIS INFORMATION)

See appendix pages vi-vii for surface material options.

- Choose Laminate Finish
- Choose ABS Edge Finish
- Choose Metal Finish only if -OF or -ML bases specified (Clear Anodized (-CA) is an option on the Post Metal Leg only)
- Choose Beam Metal Finish for tables 102"-240"L, with a Racetrack Base (-RCL, -RCP, -RCV)



# GLASS TOP



RECTANGLE TOP

### BASE KEY

OF	Open Frame	RCL	Laminate Racetrack Base
OFX	Open Frame with X Center Base	RCP	Painted Racetrack Base
OFRP	Open Frame with Painted Rectangle Center Base	RCV	Veneer Racetrack Base
OFRV	Open Frame with Veneer Rectangle Center Base		

### RECTANGLE TABLES

MODEL #	L x W	BASE QTY	GLASS SECTIONS	SEATING CAPACITY	-OF	-OFX	-OFRP	-OFRV	-RCL	-RCP	-RCV
TFT-6030-G	60 x 30	2	1	4	5,913	-	-	-	-	-	-
TFT-6036-G	60 x 36	2	1	4	6,219	-	-	-	-	-	-
TFT-6042-G	60 x 42	2	1	4	7,094	-	-	-	-	-	-
TFT-6048-G	60 x 48	2	1	4	7,683	-	-	-	-	-	-
TFT-6630-G	66 x 30	2	1	4	6,445	-	-	-	-	-	-
TFT-6636-G	66 x 36	2	1	4	6,799	-	-	-	-	-	-
TFT-6642-G	66 x 42	2	1	4	7,779	-	-	-	-	-	-
TFT-6648-G	66 x 48	2	1	4	8,446	-	-	-	-	-	-
TFT-7230-G	72 x 30	2	1	6	6,646	-	-	-	-	-	-
TFT-7236-G	72 x 36	2	1	6	7,033	-	-	-	-	-	-
TFT-7242-G	72 x 42	2	1	6	8,069	-	-	-	8,069	8,470	8,850
TFT-7248-G	72 x 48	2	1	6	8,782	-	-	-	8,782	9,197	9,591
TFT-7830-G	78 x 30	2	1	6	7,323	-	-	-	-	-	-
TFT-7836-G	78 x 36	2	1	6	7,771	-	-	-	-	-	-
TFT-7842-G	78 x 42	2	1	6	8,939	-	-	-	8,939	9,368	9,775
TFT-7848-G	78 x 48	2	1	6	9,752	-	-	-	9,752	10,195	10,616
TFT-8430-G	84 x 30	2	1	8	7,540	-	-	-	-	-	-
TFT-8436-G	84 x 36	2	1	8	8,022	-	-	-	-	-	-
TFT-8442-G	84 x 42	2	1	8	9,250	-	-	-	9,250	9,677	10,086
TFT-8448-G	84 x 48	2	1	8	10,111	-	-	-	10,111	10,554	10,977
TFT-9030-G	90 x 30	2	1	8	8,159	-	-	-	-	-	-
TFT-9036-G	90 x 36	2	1	8	8,704	-	-	-	-	-	-
TFT-9042-G	90 x 42	2	1	8	10,056	-	-	-	10,056	10,507	10,936
TFT-9048-G	90 x 48	2	1	8	11,014	-	-	-	11,014	11,481	11,924
TFT-9630-G	96 x 30	2	1	8	8,385	-	-	-	-	-	-
TFT-9636-G	96 x 36	2	1	8	8,966	-	-	-	-	-	-
TFT-9642-G	96 x 42	2	1	8	10,382	-	-	-	10,382	10,833	11,262
TFT-9648-G	96 x 48	2	1	8	11,392	-	-	-	11,392	11,858	12,301
TFT-10242-G	102 x 42	2	2	8	11,301	-	-	-	11,301	11,777	12,229
TFT-10248-G	102 x 48	2	2	8	12,424	-	-	-	12,424	12,916	13,384
TFT-10842-G	108 x 42	2	2	10	11,646	-	-	-	11,646	12,122	12,574
TFT-10848-G	108 x 48	2	2	10	12,824	-	-	-	12,824	13,315	13,783
TFT-10854-G	108 x 54	2	2	10	14,203	-	-	-	14,203	14,716	15,206
TFT-11442-G	114 x 42	2	2	10	12,622	-	-	-	12,622	13,123	13,599
TFT-11448-G	114 x 48	2	2	10	13,917	-	-	-	13,917	14,435	14,928
TFT-11454-G	114 x 54	2	2	12	15,435	-	-	-	15,435	15,976	16,491
TFT-12042-G	120 x 42	2	2	10	12,983	-	-	-	12,983	13,484	13,961
TFT-12048-G	120 x 48	2	2	10	14,338	-	-	-	14,338	14,856	15,349
TFT-12054-G	120 x 54	2	2	12	15,922	-	-	-	15,922	16,463	16,978
TFT-13242-G	132 x 42	2	3	10	14,279	-	-	-	14,279	14,800	15,296
TFT-13248-G	132 x 48	2	3	10	15,810	-	-	-	15,810	16,349	16,863
TFT-13254-G	132 x 54	2	3	12	17,597	-	-	-	17,597	18,162	18,697
TFT-14448-G	144 x 48	2	3	12	17,352	-	-	-	17,352	17,914	18,447
TFT-14454-G	144 x 54	2	2	14	19,354	-	-	-	19,354	19,940	20,499
TFT-14460-G	144 x 60	2	3	14	21,680	-	-	-	21,680	22,298	22,886
TFT-15648-G	156 x 48	3	3	14	-	22,117	22,117	22,117	22,117	22,967	23,775
TFT-15654-G	156 x 54	3	3	14	-	24,444	24,444	24,444	24,444	25,333	26,177
TFT-15660-G	156 x 60	3	3	14	-	27,163	27,163	27,163	27,163	28,099	28,988
TFT-16854-G	168 x 54	3	3	16	-	25,641	25,641	25,641	25,641	26,528	27,374
TFT-16860-G	168 x 60	3	3	16	-	28,533	28,533	28,533	28,533	29,467	30,358
TFT-18054-G	180 x 54	3	3	16	-	26,836	26,836	26,836	26,836	27,725	28,569
TFT-18060-G	180 x 60	3	3	16	-	29,899	29,899	29,899	29,899	30,835	31,725
TFT-19254-G	192 x 54	3	4	18	-	28,032	28,032	28,032	28,032	28,920	29,765
TFT-19260-G	192 x 60	3	4	18	-	31,269	31,269	31,269	31,269	32,204	33,094
TFT-20454-G	204 x 54	3	4	18	-	30,413	30,413	30,413	30,413	31,338	32,216
TFT-20460-G	204 x 60	3	4	18	-	33,962	33,962	33,962	33,962	34,935	35,862
TFT-21654-G	216 x 54	3	4	20	-	32,428	32,428	32,428	32,428	33,375	34,277
TFT-21660-G	216 x 60	3	4	20	-	36,247	36,247	36,247	36,247	37,245	38,194
TFT-22854-G	228 x 54	3	4	20	-	34,024	34,024	34,024	34,024	34,980	35,890
TFT-22860-G	228 x 60	3	4	20	-	38,066	38,066	38,066	38,066	39,072	40,030
TFT-24054-G	240 x 54	3	4	20	-	35,710	35,710	35,710	35,710	36,678	37,596
TFT-24060-G	240 x 60	3	4	20	-	39,985	39,985	39,985	39,985	41,004	41,972



# GLASS TOP

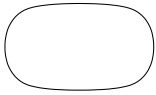

SOFT RECTANGLE TOP

### BASE KEY

OF	Open Frame	RCL	Laminate Racetrack Base
OFX	Open Frame with X Center Base	RCP	Painted Racetrack Base
OFRP	Open Frame with Painted Rectangle Center Base	RCV	Veneer Racetrack Base
OFRV	Open Frame with Veneer Rectangle Center Base		

### SOFT RECTANGLE TABLES

MODEL #	L x W	BASE QTY	GLASS SECTIONS	SEATING CAPACITY	-OF	-OFX	-OFRP	-OFRV	-RCL	-RCP	-RCV
TFF-6030-G	60 x 30	2	1	4	5,913	-	-	-	-	-	-
TFF-6036-G	60 x 36	2	1	4	6,219	-	-	-	-	-	-
TFF-6042-G	60 x 42	2	1	4	7,094	-	-	-	-	-	-
TFF-6048-G	60 x 48	2	1	4	7,683	-	-	-	-	-	-
TFF-6630-G	66 x 30	2	1	4	6,445	-	-	-	-	-	-
TFF-6636-G	66 x 36	2	1	4	6,799	-	-	-	-	-	-
TFF-6642-G	66 x 42	2	1	4	7,779	-	-	-	-	-	-
TFF-6648-G	66 x 48	2	1	4	8,446	-	-	-	-	-	-
TFF-7230-G	72 x 30	2	1	6	6,646	-	-	-	-	-	-
TFF-7236-G	72 x 36	2	1	6	7,033	-	-	-	-	-	-
TFF-7242-G	72 x 42	2	1	6	8,069	-	-	-	8,069	8,470	8,850
TFF-7248-G	72 x 48	2	1	6	8,782	-	-	-	8,782	9,197	9,591
TFF-7830-G	78 x 30	2	1	6	7,323	-	-	-	-	-	-
TFF-7836-G	78 x 36	2	1	6	7,771	-	-	-	-	-	-
TFF-7842-G	78 x 42	2	1	6	8,939	-	-	-	8,939	9,368	9,775
TFF-7848-G	78 x 48	2	1	6	9,752	-	-	-	9,752	10,195	10,616
TFF-8430-G	84 x 30	2	1	8	7,540	-	-	-	-	-	-
TFF-8436-G	84 x 36	2	1	8	8,022	-	-	-	-	-	-
TFF-8442-G	84 x 42	2	1	8	9,250	-	-	-	9,250	9,677	10,086
TFF-8448-G	84 x 48	2	1	8	10,111	-	-	-	10,111	10,554	10,977
TFF-9030-G	90 x 30	2	1	8	8,159	-	-	-	-	-	-
TFF-9036-G	90 x 36	2	1	8	8,704	-	-	-	-	-	-
TFF-9042-G	90 x 42	2	1	8	10,056	-	-	-	10,056	10,507	10,936
TFF-9048-G	90 x 48	2	1	8	11,014	-	-	-	11,014	11,481	11,924
TFF-9630-G	96 x 30	2	1	8	8,385	-	-	-	-	-	-
TFF-9636-G	96 x 36	2	1	8	8,966	-	-	-	-	-	-
TFF-9642-G	96 x 42	2	1	8	10,382	-	-	-	10,382	10,833	11,262
TFF-9648-G	96 x 48	2	1	8	11,392	-	-	-	11,392	11,858	12,301
TFF-10242-G	102 x 42	2	2	8	11,301	-	-	-	11,301	11,777	12,229
TFF-10248-G	102 x 48	2	2	8	12,424	-	-	-	12,424	12,916	13,384
TFF-10842-G	108 x 42	2	2	10	11,646	-	-	-	11,646	12,122	12,574
TFF-10848-G	108 x 48	2	2	10	12,824	-	-	-	12,824	13,315	13,783
TFF-10854-G	108 x 54	2	2	10	14,203	-	-	-	14,203	14,716	15,206
TFF-11442-G	114 x 42	2	2	10	12,622	-	-	-	12,622	13,123	13,599
TFF-11448-G	114 x 48	2	2	10	13,917	-	-	-	13,917	14,435	14,928
TFF-11454-G	114 x 54	2	2	12	15,435	-	-	-	15,435	15,976	16,491
TFF-12042-G	120 x 42	2	2	10	12,983	-	-	-	12,983	13,484	13,961
TFF-12048-G	120 x 48	2	2	10	14,338	-	-	-	14,338	14,856	15,349
TFF-12054-G	120 x 54	2	2	12	15,922	-	-	-	15,922	16,463	16,978
TFF-13242-G	132 x 42	2	3	10	14,279	-	-	-	14,279	14,800	15,296
TFF-13248-G	132 x 48	2	3	10	15,810	-	-	-	15,810	16,349	16,863
TFF-13254-G	132 x 54	2	3	12	17,597	-	-	-	17,597	18,162	18,697
TFF-14448-G	144 x 48	2	3	12	17,352	-	-	-	17,352	17,914	18,447
TFF-14454-G	144 x 54	2	2	14	19,354	-	-	-	19,354	19,940	20,499
TFF-14460-G	144 x 60	2	3	14	21,680	-	-	-	21,680	22,298	22,886
TFF-15648-G	156 x 48	3	3	14	-	22,117	22,117	22,117	22,117	22,967	23,775
TFF-15654-G	156 x 54	3	3	14	-	24,444	24,444	24,444	24,444	25,333	26,177
TFF-15660-G	156 x 60	3	3	14	-	27,163	27,163	27,163	27,163	28,099	28,988
TFF-16854-G	168 x 54	3	3	16	-	25,641	25,641	25,641	25,641	26,528	27,374
TFF-16860-G	168 x 60	3	3	16	-	28,533	28,533	28,533	28,533	29,467	30,358
TFF-18054-G	180 x 54	3	3	16	-	26,836	26,836	26,836	26,836	27,725	28,569
TFF-18060-G	180 x 60	3	3	16	-	29,899	29,899	29,899	29,899	30,835	31,725
TFF-19254-G	192 x 54	3	4	18	-	28,032	28,032	28,032	28,032	28,920	29,765
TFF-19260-G	192 x 60	3	4	18	-	31,269	31,269	31,269	31,269	32,204	33,094
TFF-20454-G	204 x 54	3	4	18	-	30,413	30,413	30,413	30,413	31,338	32,216
TFF-20460-G	204 x 60	3	4	18	-	33,962	33,962	33,962	33,962	34,935	35,862
TFF-21654-G	216 x 54	3	4	20	-	32,428	32,428	32,428	32,428	33,375	34,277
TFF-21660-G	216 x 60	3	4	20	-	36,247	36,247	36,247	36,247	37,245	38,194
TFF-22854-G	228 x 54	3	4	20	-	34,024	34,024	34,024	34,024	34,980	35,890
TFF-22860-G	228 x 60	3	4	20	-	38,066	38,066	38,066	38,066	39,072	40,030
TFF-24054-G	240 x 54	3	4	20	-	35,710	35,710	35,710	35,710	36,678	37,596
TFF-24060-G	240 x 60	3	4	20	-	39,985	39,985	39,985	39,985	41,004	41,972



# GLASS TOP

OPTIONS	CODE	PRICE	NOTES
Power & Data Options			See pages 123-133
<b>Polished Chrome Finish Options:</b>			
Polished Chrome Open Frame Base	Add -PCOF-TWB	\$2,169	
Polished Chrome Open Frame with X-Center Base	Add -PCOFX-TWB	\$3,252	
<b>Satin Glass Options:</b>			
Satin Glass	Add -TFSG	\$635	
<b>Multi-Section Tops:</b>			
102", 108", 114" and 120" one-piece tops split into two sections	Specify -2	\$764	Note: Power Matrix (center of table location only) cannot be specified when this option is selected
204", 216", 228" or 240" two-piece tops split into four sections	Specify -4	\$1,524	

## EDGE PROFILE

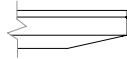

Two4Six Glass Edge

## GENERAL INFORMATION

- Tops are 1-1/8" -thick with 3/16" -thick hardwood edge band
- Seating capacity based on 27" per person
- Overall table height 29.5"
- One section of wire management channel provided per table with Post Metal Leg and Open Frame Square Bases
- Racetrack Bases have a removable access door

### REQUIRED INFORMATION (ORDER CANNOT BE ENTERED WITHOUT THIS INFORMATION)

See appendix pages vi-vii for surface material options.

- Choose Glass Finish
- Choose Veneer Finish, if applicable
- Choose Metal Finish, if applicable
- Choose Paint Finish, if applicable
- Choose Sub-Top Finish: Paint Finish or Wood Species & Finish
- Choose Beam Metal Finish for tables 102"-240"L, with a Racetrack Base (-RCL, -RCP, -RCV)



# SOLID SURFACE TOP



RECTANGLE TOP

**BASE KEY**

- OF Open Frame
- OFX Open Frame with X Center Base
- OFRP Open Frame with Painted Rectangle Center Base
- OFRV Open Frame with Veneer Rectangle Center Base
- RCL Laminate Racetrack Base
- RCP Painted Racetrack Base
- RCV Veneer Racetrack Base

**RECTANGLE TABLES**

MODEL #	L x W	BASE QTY	GLASS SECTIONS	SEATING CAPACITY	-OF	-OFX	-OFRP	-OFRV	-RCL	-RCP	-RCV
TFT-6030-SS	60 x 30	2	1	4	6,178	-	-	-	-	-	-
TFT-6036-SS	60 x 36	2	1	4	6,498	-	-	-	-	-	-
TFT-6042-SS	60 x 42	2	1	4	7,412	-	-	-	-	-	-
TFT-6048-SS	60 x 48	2	1	4	8,028	-	-	-	-	-	-
TFT-6630-SS	66 x 30	2	1	4	6,734	-	-	-	-	-	-
TFT-6636-SS	66 x 36	2	1	4	7,104	-	-	-	-	-	-
TFT-6642-SS	66 x 42	2	1	4	8,128	-	-	-	-	-	-
TFT-6648-SS	66 x 48	2	1	4	8,825	-	-	-	-	-	-
TFT-7230-SS	72 x 30	2	1	6	6,944	-	-	-	-	-	-
TFT-7236-SS	72 x 36	2	1	6	7,349	-	-	-	-	-	-
TFT-7242-SS	72 x 42	2	1	6	8,431	-	-	-	8,431	8,850	9,247
TFT-7248-SS	72 x 48	2	1	6	9,176	-	-	-	9,176	9,609	10,022
TFT-7830-SS	78 x 30	2	1	6	7,652	-	-	-	-	-	-
TFT-7836-SS	78 x 36	2	1	6	8,120	-	-	-	-	-	-
TFT-7842-SS	78 x 42	2	1	6	9,340	-	-	-	9,340	9,789	10,214
TFT-7848-SS	78 x 48	2	1	6	10,190	-	-	-	10,190	10,653	11,093
TFT-8430-SS	84 x 30	2	1	8	7,878	-	-	-	-	-	-
TFT-8436-SS	84 x 36	2	1	8	8,382	-	-	-	-	-	-
TFT-8442-SS	84 x 42	2	1	8	9,665	-	-	-	9,665	10,111	10,538
TFT-8448-SS	84 x 48	2	1	8	10,565	-	-	-	10,565	11,027	11,469
TFT-9030-SS	90 x 30	2	1	8	8,525	-	-	-	-	-	-
TFT-9036-SS	90 x 36	2	1	8	9,094	-	-	-	-	-	-
TFT-9042-SS	90 x 42	2	1	8	10,507	-	-	-	10,507	10,979	11,427
TFT-9048-SS	90 x 48	2	1	8	11,508	-	-	-	11,508	11,996	12,459
TFT-9630-SS	96 x 30	2	1	8	8,762	-	-	-	-	-	-
TFT-9636-SS	96 x 36	2	1	8	9,368	-	-	-	-	-	-
TFT-9642-SS	96 x 42	2	1	8	10,848	-	-	-	10,848	11,319	11,767
TFT-9648-SS	96 x 48	2	1	8	11,903	-	-	-	11,903	12,390	12,853
TFT-10242-SS	102 x 42	2	2	8	11,808	-	-	-	11,808	12,305	12,778
TFT-10248-SS	102 x 48	2	2	8	12,982	-	-	-	12,982	13,495	13,984
TFT-10842-SS	108 x 42	2	2	10	12,168	-	-	-	12,168	12,666	13,138
TFT-10848-SS	108 x 48	2	2	10	13,399	-	-	-	13,399	13,913	14,402
TFT-10854-SS	108 x 54	2	2	10	14,840	-	-	-	14,840	15,376	15,888
TFT-11442-SS	114 x 42	2	2	10	13,189	-	-	-	13,189	13,712	14,209
TFT-11448-SS	114 x 48	2	2	10	14,542	-	-	-	14,542	15,083	15,598
TFT-11454-SS	114 x 54	2	2	12	16,128	-	-	-	16,128	16,693	17,231
TFT-12042-SS	120 x 42	2	2	10	13,565	-	-	-	13,565	14,089	14,587
TFT-12048-SS	120 x 48	2	2	10	14,982	-	-	-	14,982	15,523	16,038
TFT-12054-SS	120 x 54	2	2	12	16,636	-	-	-	16,636	17,202	17,740
TFT-13242-SS	132 x 42	2	3	10	14,920	-	-	-	14,920	15,464	15,983
TFT-13248-SS	132 x 48	2	3	10	16,519	-	-	-	16,519	17,083	17,619
TFT-13254-SS	132 x 54	2	3	12	18,387	-	-	-	18,387	18,977	19,536
TFT-14448-SS	144 x 48	2	3	12	18,131	-	-	-	18,131	18,718	19,275
TFT-14454-SS	144 x 54	2	2	14	20,222	-	-	-	20,222	20,835	21,419
TFT-14460-SS	144 x 60	2	3	14	22,653	-	-	-	22,653	23,298	23,913
TFT-15648-SS	156 x 48	3	3	14	-	23,109	23,109	23,109	23,109	23,997	24,842
TFT-15654-SS	156 x 54	3	3	14	-	25,541	25,541	25,541	25,541	26,470	27,352
TFT-15660-SS	156 x 60	3	3	14	-	28,382	28,382	28,382	28,382	29,360	30,289
TFT-16854-SS	168 x 54	3	3	16	-	26,791	26,791	26,791	26,791	27,719	28,602
TFT-16860-SS	168 x 60	3	3	16	-	29,813	29,813	29,813	29,813	30,790	31,720
TFT-18054-SS	180 x 54	3	3	16	-	28,040	28,040	28,040	28,040	28,969	29,851
TFT-18060-SS	180 x 60	3	3	16	-	31,241	31,241	31,241	31,241	32,219	33,148
TFT-19254-SS	192 x 54	3	4	18	-	29,290	29,290	29,290	29,290	30,217	31,101
TFT-19260-SS	192 x 60	3	4	18	-	32,672	32,672	32,672	32,672	33,649	34,579
TFT-20454-SS	204 x 54	3	4	18	-	31,777	31,777	31,777	31,777	32,744	33,662
TFT-20460-SS	204 x 60	3	4	18	-	35,486	35,486	35,486	35,486	36,503	37,471
TFT-21654-SS	216 x 54	3	4	20	-	33,883	33,883	33,883	33,883	34,873	35,815
TFT-21660-SS	216 x 60	3	4	20	-	37,874	37,874	37,874	37,874	38,917	39,908
TFT-22854-SS	228 x 54	3	4	20	-	35,551	35,551	35,551	35,551	36,550	37,500
TFT-22860-SS	228 x 60	3	4	20	-	39,774	39,774	39,774	39,774	40,825	41,826
TFT-24054-SS	240 x 54	3	4	20	-	37,313	37,313	37,313	37,313	38,323	39,283
TFT-24060-SS	240 x 60	3	4	20	-	41,779	41,779	41,779	41,779	42,843	43,856



# SOLID SURFACE TOP

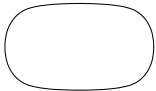

SOFT RECTANGLE TOP

**BASE KEY**

- OF Open Frame
- OFX Open Frame with X Center Base
- OFRP Open Frame with Painted Rectangle Center Base
- OFRV Open Frame with Veneer Rectangle Center Base
- RCL Laminate Racetrack Base
- RCP Painted Racetrack Base
- RCV Veneer Racetrack Base

**SOFT RECTANGLE TABLES**

MODEL #	L x W	BASE QTY	GLASS SECTIONS	SEATING CAPACITY	-OF	-OFX	-OFRP	-OFRV	-RCL	-RCP	-RCV
TFF-6030-SS	60 x 30	2	1	4	6,178	-	-	-	-	-	-
TFF-6036-SS	60 x 36	2	1	4	6,498	-	-	-	-	-	-
TFF-6042-SS	60 x 42	2	1	4	7,412	-	-	-	-	-	-
TFF-6048-SS	60 x 48	2	1	4	8,028	-	-	-	-	-	-
TFF-6630-SS	66 x 30	2	1	4	6,734	-	-	-	-	-	-
TFF-6636-SS	66 x 36	2	1	4	7,104	-	-	-	-	-	-
TFF-6642-SS	66 x 42	2	1	4	8,128	-	-	-	-	-	-
TFF-6648-SS	66 x 48	2	1	4	8,825	-	-	-	-	-	-
TFF-7230-SS	72 x 30	2	1	6	6,944	-	-	-	-	-	-
TFF-7236-SS	72 x 36	2	1	6	7,349	-	-	-	-	-	-
TFF-7242-SS	72 x 42	2	1	6	8,431	-	-	-	8,431	8,850	9,247
TFF-7248-SS	72 x 48	2	1	6	9,176	-	-	-	9,176	9,609	10,022
TFF-7830-SS	78 x 30	2	1	6	7,652	-	-	-	-	-	-
TFF-7836-SS	78 x 36	2	1	6	8,120	-	-	-	-	-	-
TFF-7842-SS	78 x 42	2	1	6	9,340	-	-	-	9,340	9,789	10,214
TFF-7848-SS	78 x 48	2	1	6	10,190	-	-	-	10,190	10,653	11,093
TFF-8430-SS	84 x 30	2	1	8	7,878	-	-	-	-	-	-
TFF-8436-SS	84 x 36	2	1	8	8,382	-	-	-	-	-	-
TFF-8442-SS	84 x 42	2	1	8	9,665	-	-	-	9,665	10,111	10,538
TFF-8448-SS	84 x 48	2	1	8	10,565	-	-	-	10,565	11,027	11,469
TFF-9030-SS	90 x 30	2	1	8	8,525	-	-	-	-	-	-
TFF-9036-SS	90 x 36	2	1	8	9,094	-	-	-	-	-	-
TFF-9042-SS	90 x 42	2	1	8	10,507	-	-	-	10,507	10,979	11,427
TFF-9048-SS	90 x 48	2	1	8	11,508	-	-	-	11,508	11,996	12,459
TFF-9630-SS	96 x 30	2	1	8	8,762	-	-	-	-	-	-
TFF-9636-SS	96 x 36	2	1	8	9,368	-	-	-	-	-	-
TFF-9642-SS	96 x 42	2	1	8	10,848	-	-	-	10,848	11,319	11,767
TFF-9648-SS	96 x 48	2	1	8	11,903	-	-	-	11,903	12,390	12,853
TFF-10242-SS	102 x 42	2	2	8	11,808	-	-	-	11,808	12,305	12,778
TFF-10248-SS	102 x 48	2	2	8	12,982	-	-	-	12,982	13,495	13,984
TFF-10842-SS	108 x 42	2	2	10	12,168	-	-	-	12,168	12,666	13,138
TFF-10848-SS	108 x 48	2	2	10	13,399	-	-	-	13,399	13,913	14,402
TFF-10854-SS	108 x 54	2	2	10	14,840	-	-	-	14,840	15,376	15,888
TFF-11442-SS	114 x 42	2	2	10	13,189	-	-	-	13,189	13,712	14,209
TFF-11448-SS	114 x 48	2	2	10	14,542	-	-	-	14,542	15,083	15,598
TFF-11454-SS	114 x 54	2	2	12	16,128	-	-	-	16,128	16,693	17,231
TFF-12042-SS	120 x 42	2	2	10	13,565	-	-	-	13,565	14,089	14,587
TFF-12048-SS	120 x 48	2	2	10	14,982	-	-	-	14,982	15,523	16,038
TFF-12054-SS	120 x 54	2	2	12	16,636	-	-	-	16,636	17,202	17,740
TFF-13242-SS	132 x 42	2	3	10	14,920	-	-	-	14,920	15,464	15,983
TFF-13248-SS	132 x 48	2	3	10	16,519	-	-	-	16,519	17,083	17,619
TFF-13254-SS	132 x 54	2	3	12	18,387	-	-	-	18,387	18,977	19,536
TFF-14448-SS	144 x 48	2	3	12	18,131	-	-	-	18,131	18,718	19,275
TFF-14454-SS	144 x 54	2	2	14	20,222	-	-	-	20,222	20,835	21,419
TFF-14460-SS	144 x 60	2	3	14	22,653	-	-	-	22,653	23,298	23,913
TFF-15648-SS	156 x 48	3	3	14	-	23,109	23,109	23,109	23,109	23,997	24,842
TFF-15654-SS	156 x 54	3	3	14	-	25,541	25,541	25,541	25,541	26,470	27,352
TFF-15660-SS	156 x 60	3	3	14	-	28,382	28,382	28,382	28,382	29,360	30,289
TFF-16854-SS	168 x 54	3	3	16	-	26,791	26,791	26,791	26,791	27,719	28,602
TFF-16860-SS	168 x 60	3	3	16	-	29,813	29,813	29,813	29,813	30,790	31,720
TFF-18054-SS	180 x 54	3	3	16	-	28,040	28,040	28,040	28,040	28,969	29,851
TFF-18060-SS	180 x 60	3	3	16	-	31,241	31,241	31,241	31,241	32,219	33,148
TFF-19254-SS	192 x 54	3	4	18	-	29,290	29,290	29,290	29,290	30,217	31,101
TFF-19260-SS	192 x 60	3	4	18	-	32,672	32,672	32,672	32,672	33,649	34,579
TFF-20454-SS	204 x 54	3	4	18	-	31,777	31,777	31,777	31,777	32,744	33,662
TFF-20460-SS	204 x 60	3	4	18	-	35,486	35,486	35,486	35,486	36,503	37,471
TFF-21654-SS	216 x 54	3	4	20	-	33,883	33,883	33,883	33,883	34,873	35,815
TFF-21660-SS	216 x 60	3	4	20	-	37,874	37,874	37,874	37,874	38,917	39,908
TFF-22854-SS	228 x 54	3	4	20	-	35,551	35,551	35,551	35,551	36,550	37,500
TFF-22860-SS	228 x 60	3	4	20	-	39,774	39,774	39,774	39,774	40,825	41,826
TFF-24054-SS	240 x 54	3	4	20	-	37,313	37,313	37,313	37,313	38,323	39,283
TFF-24060-SS	240 x 60	3	4	20	-	41,779	41,779	41,779	41,779	42,843	43,856





# SOLID SURFACE TOP

OPTIONS	CODE	PRICE	NOTES
Power & Data Options			See pages 123-133
<b>Polished Chrome Finish Options:</b>			
Polished Chrome Open Frame Base	Add -PCOF-TWB	\$2,169	
Polished Chrome Open Frame with X-Center Base	Add -PCOFX-TWB	\$3,252	
<b>Multi-Section Tops:</b>			
102", 108", 114" and 120" one-piece tops split into two sections	Specify -2	\$764	Note: Power Matrix (center of table location only) cannot be specified when this option is selected
204", 216", 228" or 240" two-piece tops split into four sections	Specify -4	\$1,524	

## EDGE PROFILE



Two4Six Solid Surface Edge

## GENERAL INFORMATION

- Seating capacity based on 27" per person
- Overall table height 29.5"
- One section of wire management channel provided per table with Post Metal Leg and Open Frame Square Bases
- Racetrack Bases have a removable access door

**REQUIRED INFORMATION (ORDER CANNOT BE ENTERED WITHOUT THIS INFORMATION)**

See appendix pages vi-vii for surface material options.

- Choose Solid Surface Finish
- Choose Metal Finish
- Choose Beam Metal Finish for tables 102"-240"L, with a Racetrack Base (-RCL, -RCP, -RCV)



# VENEER TOP WITH HARDWOOD EDGE / VENEER CASE



D-SHAPE TOP

### BASE KEY

OF	Open Frame	RCL	Laminate Racetrack Base
ML	Post Metal Leg	RCP	Painted Racetrack Base
		RCV	Veneer Racetrack Base

## D-SHAPE TOP // 60" CREDENZA BASE // SEATED HEIGHT

MODEL #	LENGTH	WIDTH	HEIGHT	CREDENZA BASE	SEATING CAPACITY	-OF	-ML	-RCL	-RCP	-RCV
TFL-3060-V	60	30	29-1/2	60	3	8,605	8,605	-	-	-
TFL-3660-V	60	36	29-1/2	60	3	8,801	8,801	-	-	-
TFL-4260-V	60	42	29-1/2	60	3	9,783	9,783	-	-	-
TFL-4860-V	60	48	29-1/2	60	3	10,341	10,341	-	-	-
TFL-3066-V	66	30	29-1/2	60	3	9,214	9,214	-	-	-
TFL-3666-V	66	36	29-1/2	60	3	9,441	9,441	-	-	-
TFL-4266-V	66	42	29-1/2	60	3	10,514	10,514	-	-	-
TFL-4866-V	66	48	29-1/2	60	3	11,132	11,132	-	-	-
TFL-3072-V	72	30	29-1/2	60	3	9,343	9,343	-	-	-
TFL-3672-V	72	36	29-1/2	60	3	9,591	9,591	-	-	-
TFL-4272-V	72	42	29-1/2	60	3	10,700	10,700	10,700	11,223	11,777
TFL-4872-V	72	48	29-1/2	60	3	11,348	11,348	11,348	11,889	12,462
TFL-3078-V	78	30	29-1/2	60	5	10,130	10,130	-	-	-
TFL-3678-V	78	36	29-1/2	60	5	10,417	10,417	-	-	-
TFL-4278-V	78	42	29-1/2	60	5	11,642	11,642	11,642	12,201	12,794
TFL-4878-V	78	48	29-1/2	60	5	12,367	12,367	12,367	12,945	13,558
TFL-3084-V	84	30	29-1/2	60	5	10,269	10,269	-	-	-
TFL-3684-V	84	36	29-1/2	60	5	10,578	10,578	-	-	-
TFL-4284-V	84	42	29-1/2	60	5	11,840	11,840	11,840	12,400	12,993
TFL-4884-V	84	48	29-1/2	60	5	12,597	12,597	12,597	13,176	13,789
TFL-3090-V	90	30	29-1/2	60	5	10,948	10,948	-	-	-
TFL-3690-V	90	36	29-1/2	60	5	11,297	11,297	-	-	-
TFL-4290-V	90	42	29-1/2	60	5	12,665	12,665	12,665	13,253	13,877
TFL-4890-V	90	48	29-1/2	60	5	13,493	13,493	13,493	14,102	14,747
TFL-3096-V	96	30	29-1/2	60	5	11,094	11,094	-	-	-
TFL-3696-V	96	36	29-1/2	60	5	11,466	11,466	-	-	-
TFL-4296-V	96	42	29-1/2	60	5	12,874	12,874	12,874	13,462	14,086
TFL-4896-V	96	48	29-1/2	60	5	13,736	13,736	13,736	14,344	14,989

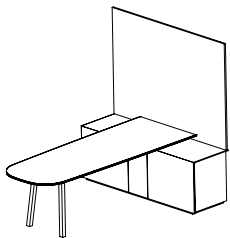

Shown with optional Monitor Panel (-MP)

### OPTIONS

Power & Data Options

See pages 123-133

#### Polished Chrome Finish Options:

Polished Chrome Open Frame Base	Add -PCOF-TWA	\$1,230
Polished Chrome Post Metal Legs	Add -PCML-TWA	\$567

#### Credenza Base Options:

60"-wide Monitor Panel	Add -MP	\$2,612
Pull-out Waste/Recycling Unit (Left End Opening)	Add -TE	\$460
Locks	Add -L	\$232

### EDGE PROFILE



Two4Six Cutback Edge

### GENERAL INFORMATION

- Tops are 1-1/8" -thick with 3/16" -thick hardwood edge band
- Seating capacity based on 27" per person
- Overall table height 29.5". Overall height 78" if Monitor Panel is specified.
- Standard with quarter cut veneer
- Pull-Out Waste/Recycling option is located on left side of unit if specified
- Adjustable shelves standard
- Access door on the credenza base standard with a lock. All doors will be keyed alike if locks are specified.
- Credenza base is 22" -deep, the Monitor Panel adds 2" making the depth 24"
- Plinth base is veneer and recessed 1" on all sides
- One section of wire management channel provided per table with Post Metal Leg and Open Frame Bases
- Pull-Out Waste/Recycling Bin size: 14" x 10-1/2" x 18"
- Only Woodgrain Laminate options are available for the Racetrack Base
- Racetrack Bases have a removable access door

#### REQUIRED INFORMATION (ORDER CANNOT BE ENTERED WITHOUT THIS INFORMATION)

See appendix pages vi-vii for surface material options.

- Choose Veneer Finish
- Choose Metal Finish, if -OF or -ML Base is specified (Clear Anodized (-CA) is an option on the Post Metal Leg only)



# INSET LAMINATE TOP WITH HARDWOOD EDGE / VENEER CASE



D-SHAPE TOP

### BASE KEY

OF	Open Frame	RCL	Laminate Racetrack Base
ML	Post Metal Leg	RCP	Painted Racetrack Base
		RCV	Veneer Racetrack Base

## D-SHAPE TOP // 60" CREDENZA BASE // SEATED HEIGHT

MODEL #	LENGTH	WIDTH	HEIGHT	CREDENZA BASE	SEATING CAPACITY	-OF	-ML	-RCL	-RCP	-RCV
TFL-3060-P	60	30	29-1/2	60	3	8,132	8,132	-	-	-
TFL-3660-P	60	36	29-1/2	60	3	8,317	8,317	-	-	-
TFL-4260-P	60	42	29-1/2	60	3	9,245	9,245	-	-	-
TFL-4860-P	60	48	29-1/2	60	3	9,773	9,773	-	-	-
TFL-3066-P	66	30	29-1/2	60	3	8,708	8,708	-	-	-
TFL-3666-P	66	36	29-1/2	60	3	8,922	8,922	-	-	-
TFL-4266-P	66	42	29-1/2	60	3	9,936	9,936	-	-	-
TFL-4866-P	66	48	29-1/2	60	3	10,520	10,520	-	-	-
TFL-3072-P	72	30	29-1/2	60	3	8,830	8,830	-	-	-
TFL-3672-P	72	36	29-1/2	60	3	9,064	9,064	-	-	-
TFL-4272-P	72	42	29-1/2	60	3	10,112	10,112	10,112	10,606	11,130
TFL-4872-P	72	48	29-1/2	60	3	10,724	10,724	10,724	11,236	11,777
TFL-3078-P	78	30	29-1/2	60	5	9,573	9,573	-	-	-
TFL-3678-P	78	36	29-1/2	60	5	9,845	9,845	-	-	-
TFL-4278-P	78	42	29-1/2	60	5	11,002	11,002	11,002	11,530	12,091
TFL-4878-P	78	48	29-1/2	60	5	11,687	11,687	11,687	12,234	12,813
TFL-3084-P	84	30	29-1/2	60	5	9,705	9,705	-	-	-
TFL-3684-P	84	36	29-1/2	60	5	9,997	9,997	-	-	-
TFL-4284-P	84	42	29-1/2	60	5	11,189	11,189	11,189	11,718	12,279
TFL-4884-P	84	48	29-1/2	60	5	11,905	11,905	11,905	12,452	13,031
TFL-3090-P	90	30	29-1/2	60	5	10,346	10,346	-	-	-
TFL-3690-P	90	36	29-1/2	60	5	10,676	10,676	-	-	-
TFL-4290-P	90	42	29-1/2	60	5	11,969	11,969	11,969	12,525	13,114
TFL-4890-P	90	48	29-1/2	60	5	12,751	12,751	12,751	13,327	13,936
TFL-3096-P	96	30	29-1/2	60	5	10,484	10,484	-	-	-
TFL-3696-P	96	36	29-1/2	60	5	10,836	10,836	-	-	-
TFL-4296-P	96	42	29-1/2	60	5	12,166	12,166	12,166	12,722	13,312
TFL-4896-P	96	48	29-1/2	60	5	12,981	12,981	12,981	13,556	14,165

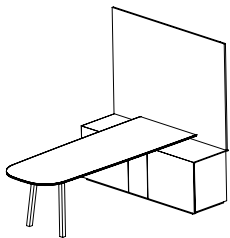

Shown with optional Monitor Panel (-MP)

### OPTIONS

Power & Data Options

See pages 123-133

#### Polished Chrome Finish Options:

Polished Chrome Open Frame Base	Add -PCOF-TWA	\$1,230
Polished Chrome Post Metal Legs	Add -PCML-TWA	\$567

#### Credenza Base Options:

60"-wide Monitor Panel	Add -MP	\$2,612
Pull-out Waste/Recycling Unit (Left End Opening)	Add -TE	\$460
Locks	Add -L	\$232

### EDGE PROFILE



Two4Six Cutback Edge

### GENERAL INFORMATION

- Tops are 1-1/8" -thick with 3/16" -thick hardwood edge band
- Seating capacity based on 27" per person
- Overall table height 29.5". Overall height 78" if Monitor Panel is specified.
- Standard with quarter cut veneer
- Pull-Out Waste/Recycling option is located on left side of unit if specified
- Adjustable shelves standard
- Access door on the credenza base standard with a lock. All doors will be keyed alike if locks are specified.
- Credenza base is 22" -deep, the Monitor Panel adds 2" making the depth 24"
- Plinth base is veneer and recessed 1" on all sides
- One section of wire management channel provided per table with Post Metal Leg and Open Frame Bases
- Pull-Out Waste/Recycling Bin size: 14" x 10-1/2" x 18"
- Only Woodgrain Laminate options are available for the Racetrack Base
- Racetrack Bases have a removable access door

#### REQUIRED INFORMATION (ORDER CANNOT BE ENTERED WITHOUT THIS INFORMATION)

See appendix pages vi-vii for surface material options.

- Choose Laminate Finish
- Choose Wood Species & Finish for Hardwood Edge
- Choose Veneer Finish
- Choose Metal Finish, if -OF or -ML Base is specified (Clear Anodized (-CA) is an option on the Post Metal Leg only)



# LAMINATE TOP WITH ABS CUTBACK EDGE / VENEER CASE



D-SHAPE TOP

### BASE KEY

OF	Open Frame	RCL	Laminate Racetrack Base
ML	Post Metal Leg	RCP	Painted Racetrack Base
		RCV	Veneer Racetrack Base

## D-SHAPE TOP // 60" CREDENZA BASE // SEATED HEIGHT

MODEL #	LENGTH	WIDTH	HEIGHT	CREDENZA BASE	SEATING CAPACITY	-OF	-ML	-RCL	-RCP	-RCV
TFL-3060-PA	60	30	29-1/2	60	3	8,132	8,132	-	-	-
TFL-3660-PA	60	36	29-1/2	60	3	8,317	8,317	-	-	-
TFL-4260-PA	60	42	29-1/2	60	3	9,245	9,245	-	-	-
TFL-4860-PA	60	48	29-1/2	60	3	9,773	9,773	-	-	-
TFL-3066-PA	66	30	29-1/2	60	3	8,708	8,708	-	-	-
TFL-3666-PA	66	36	29-1/2	60	3	8,922	8,922	-	-	-
TFL-4266-PA	66	42	29-1/2	60	3	9,936	9,936	-	-	-
TFL-4866-PA	66	48	29-1/2	60	3	10,520	10,520	-	-	-
TFL-3072-PA	72	30	29-1/2	60	3	8,830	8,830	-	-	-
TFL-3672-PA	72	36	29-1/2	60	3	9,064	9,064	-	-	-
TFL-4272-PA	72	42	29-1/2	60	3	10,112	10,112	10,112	10,606	11,130
TFL-4872-PA	72	48	29-1/2	60	3	10,724	10,724	10,724	11,236	11,777
TFL-3078-PA	78	30	29-1/2	60	5	9,573	9,573	-	-	-
TFL-3678-PA	78	36	29-1/2	60	5	9,845	9,845	-	-	-
TFL-4278-PA	78	42	29-1/2	60	5	11,002	11,002	11,002	11,530	12,091
TFL-4878-PA	78	48	29-1/2	60	5	11,687	11,687	11,687	12,234	12,813
TFL-3084-PA	84	30	29-1/2	60	5	9,705	9,705	-	-	-
TFL-3684-PA	84	36	29-1/2	60	5	9,997	9,997	-	-	-
TFL-4284-PA	84	42	29-1/2	60	5	11,189	11,189	11,189	11,718	12,279
TFL-4884-PA	84	48	29-1/2	60	5	11,905	11,905	11,905	12,452	13,031
TFL-3090-PA	90	30	29-1/2	60	5	10,346	10,346	-	-	-
TFL-3690-PA	90	36	29-1/2	60	5	10,676	10,676	-	-	-
TFL-4290-PA	90	42	29-1/2	60	5	11,969	11,969	11,969	12,525	13,114
TFL-4890-PA	90	48	29-1/2	60	5	12,751	12,751	12,751	13,327	13,936
TFL-3096-PA	96	30	29-1/2	60	5	10,484	10,484	-	-	-
TFL-3696-PA	96	36	29-1/2	60	5	10,836	10,836	-	-	-
TFL-4296-PA	96	42	29-1/2	60	5	12,166	12,166	12,166	12,722	13,312
TFL-4896-PA	96	48	29-1/2	60	5	12,981	12,981	12,981	13,556	14,165

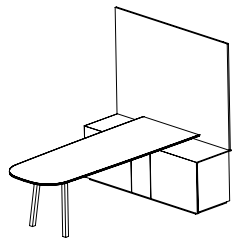

Shown with optional Monitor Panel (-MP)

### OPTIONS

Power & Data Options

See pages 123-133

#### Polished Chrome Finish Options:

Polished Chrome Open Frame Base	Add -PCOF-TWA	\$1,230
Polished Chrome Post Metal Legs	Add -PCML-TWA	\$567

#### Credenza Base Options:

60"-wide Monitor Panel	Add -MP	\$2,612
Pull-out Waste/Recycling Unit (Left End Opening)	Add -TE	\$460
Locks	Add -L	\$232

### EDGE PROFILE



Two4Six Cutback Edge

### GENERAL INFORMATION

- Tops are 1-1/8" -thick
- Seating capacity based on 27" per person
- Overall table height 29.5". Overall height 78" if Monitor Panel is specified.
- Standard with quarter cut veneer
- Pull-Out Waste/Recycling option is located on left side of unit if specified
- Adjustable shelves standard
- Access door on the credenza base standard with a lock. All doors will be keyed alike if locks are specified.
- Credenza base is 22" -deep, the Monitor Panel adds 2" making the depth 24"
- Plinth base is veneer and recessed 1" on all sides
- One section of wire management channel provided per table with Post Metal Leg and Open Frame Bases
- Pull-Out Waste/Recycling Bin size: 14" x 10-1/2" x 18"
- Only Woodgrain Laminate options are available for the Racetrack Base
- Racetrack Bases have a removable access door

#### REQUIRED INFORMATION (ORDER CANNOT BE ENTERED WITHOUT THIS INFORMATION)

See appendix pages vi-vii for surface material options.

- Choose Laminate Finish
- Choose ABS Edge Finish
- Choose Veneer Finish
- Choose Metal Finish, if -OF or -ML Base is specified (Clear Anodized (-CA) is an option on the Post Metal Leg only)



# LAMINATE TOP WITH ABS SQUARE EDGE / VENEER CASE



D-SHAPE TOP

### BASE KEY

OF	Open Frame	RCL	Laminate Racetrack Base
ML	Post Metal Leg	RCP	Painted Racetrack Base
		RCV	Veneer Racetrack Base

## D-SHAPE TOP // 60" CREDENZA BASE // SEATED HEIGHT

MODEL #	LENGTH	WIDTH	HEIGHT	CREDENZA BASE	SEATING CAPACITY	-OF	-ML	-RCL	-RCP	-RCV
TFL-3060-PE	60	30	29-1/2	60	3	7,728	7,728	-	-	-
TFL-3660-PE	60	36	29-1/2	60	3	7,904	7,904	-	-	-
TFL-4260-PE	60	42	29-1/2	60	3	8,786	8,786	-	-	-
TFL-4860-PE	60	48	29-1/2	60	3	9,287	9,287	-	-	-
TFL-3066-PE	66	30	29-1/2	60	3	8,275	8,275	-	-	-
TFL-3666-PE	66	36	29-1/2	60	3	8,479	8,479	-	-	-
TFL-4266-PE	66	42	29-1/2	60	3	9,442	9,442	-	-	-
TFL-4866-PE	66	48	29-1/2	60	3	9,997	9,997	-	-	-
TFL-3072-PE	72	30	29-1/2	60	3	8,391	8,391	-	-	-
TFL-3672-PE	72	36	29-1/2	60	3	8,613	8,613	-	-	-
TFL-4272-PE	72	42	29-1/2	60	3	9,609	9,609	9,609	10,079	10,576
TFL-4872-PE	72	48	29-1/2	60	3	10,191	10,191	10,191	10,677	11,191
TFL-3078-PE	78	30	29-1/2	60	5	9,097	9,097	-	-	-
TFL-3678-PE	78	36	29-1/2	60	5	9,355	9,355	-	-	-
TFL-4278-PE	78	42	29-1/2	60	5	10,455	10,455	10,455	10,957	11,490
TFL-4878-PE	78	48	29-1/2	60	5	11,106	11,106	11,106	11,625	12,176
TFL-3084-PE	84	30	29-1/2	60	5	9,222	9,222	-	-	-
TFL-3684-PE	84	36	29-1/2	60	5	9,500	9,500	-	-	-
TFL-4284-PE	84	42	29-1/2	60	5	10,633	10,633	10,633	11,136	11,668
TFL-4884-PE	84	48	29-1/2	60	5	11,313	11,313	11,313	11,833	12,383
TFL-3090-PE	90	30	29-1/2	60	5	9,832	9,832	-	-	-
TFL-3690-PE	90	36	29-1/2	60	5	10,145	10,145	-	-	-
TFL-4290-PE	90	42	29-1/2	60	5	11,374	11,374	11,374	11,902	12,462
TFL-4890-PE	90	48	29-1/2	60	5	12,117	12,117	12,117	12,664	13,243
TFL-3096-PE	96	30	29-1/2	60	5	9,963	9,963	-	-	-
TFL-3696-PE	96	36	29-1/2	60	5	10,297	10,297	-	-	-
TFL-4296-PE	96	42	29-1/2	60	5	11,561	11,561	11,561	12,089	12,650
TFL-4896-PE	96	48	29-1/2	60	5	12,335	12,335	12,335	12,881	13,461

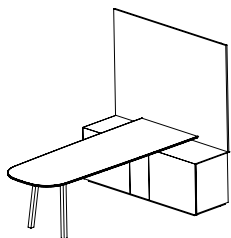

Shown with optional Monitor Panel (-MP)

### OPTIONS

Power & Data Options

See pages 123-133

#### Polished Chrome Finish Options:

Polished Chrome Open Frame Base	Add -PCOF-TWA	\$1,230
Polished Chrome Post Metal Legs	Add -PCML-TWA	\$567

#### Credenza Base Options:

60"-wide Monitor Panel	Add -MP	\$2,612
Pull-out Waste/Recycling Unit (Left End Opening)	Add -TE	\$460
Locks	Add -L	\$232

### EDGE PROFILE



Two4Six Square Edge

### GENERAL INFORMATION

- Tops are 1-1/8"-thick
- Seating capacity based on 27" per person
- Overall table height 29.5". Overall height 78" if Monitor Panel is specified.
- Standard with quarter cut veneer
- Pull-Out Waste/Recycling option is located on left side of unit if specified
- Adjustable shelves standard
- Access door on the credenza base standard with a lock. All doors will be keyed alike if locks are specified.
- Credenza base is 22"-deep, the Monitor Panel adds 2" making the depth 24"
- Plinth base is veneer and recessed 1" on all sides
- One section of wire management channel provided per table with Post Metal Leg and Open Frame Bases
- Pull-Out Waste/Recycling Bin size: 14" x 10-1/2" x 18"
- Only Woodgrain Laminate options are available for the Racetrack Base
- Racetrack Bases have a removable access door

#### REQUIRED INFORMATION (ORDER CANNOT BE ENTERED WITHOUT THIS INFORMATION)

See appendix pages vi-vii for surface material options.

- Choose Laminate Finish
- Choose ABS Edge Finish
- Choose Veneer Finish
- Choose Metal Finish, if -OF or -ML Base is specified (Clear Anodized (-CA) is an option on the Post Metal Leg only)



# GLASS TOP / VENEER CASE



D-SHAPE TOP

### BASE KEY

OF Open Frame

RCL Laminate Racetrack Base  
RCP Painted Racetrack Base  
RCV Veneer Racetrack Base

## D-SHAPE TOP // 60" CRENZNA BASE // SEATED HEIGHT

MODEL #	LENGTH	WIDTH	HEIGHT	CRENZNA BASE	SEATING CAPACITY	-OF	-RCL	-RCP	-RCV
TFL-3060-G	60	30	29-1/2	60	3	13,424	-	-	-
TFL-3660-G	60	36	29-1/2	60	3	13,730	-	-	-
TFL-4260-G	60	42	29-1/2	60	3	15,262	-	-	-
TFL-4860-G	60	48	29-1/2	60	3	16,132	-	-	-
TFL-3066-G	66	30	29-1/2	60	3	14,374	-	-	-
TFL-3666-G	66	36	29-1/2	60	3	14,728	-	-	-
TFL-4266-G	66	42	29-1/2	60	3	16,402	-	-	-
TFL-4866-G	66	48	29-1/2	60	3	17,366	-	-	-
TFL-3072-G	72	30	29-1/2	60	3	14,576	-	-	-
TFL-3672-G	72	36	29-1/2	60	3	14,962	-	-	-
TFL-4272-G	72	42	29-1/2	60	3	16,692	16,692	17,508	18,373
TFL-4872-G	72	48	29-1/2	60	3	17,703	17,703	18,547	19,441
TFL-3078-G	78	30	29-1/2	60	5	15,803	-	-	-
TFL-3678-G	78	36	29-1/2	60	5	16,251	-	-	-
TFL-4278-G	78	42	29-1/2	60	5	18,162	18,162	19,034	19,959
TFL-4878-G	78	48	29-1/2	60	5	19,293	19,293	20,195	21,151
TFL-3084-G	84	30	29-1/2	60	5	16,020	-	-	-
TFL-3684-G	84	36	29-1/2	60	5	16,502	-	-	-
TFL-4284-G	84	42	29-1/2	60	5	18,471	18,471	19,344	20,270
TFL-4884-G	84	48	29-1/2	60	5	19,652	19,652	20,555	21,511
TFL-3090-G	90	30	29-1/2	60	5	17,079	-	-	-
TFL-3690-G	90	36	29-1/2	60	5	17,624	-	-	-
TFL-4290-G	90	42	29-1/2	60	5	19,758	19,758	20,675	21,649
TFL-4890-G	90	48	29-1/2	60	5	21,050	21,050	22,000	23,006
TFL-3096-G	96	30	29-1/2	60	5	17,307	-	-	-
TFL-3696-G	96	36	29-1/2	60	5	17,887	-	-	-
TFL-4296-G	96	42	29-1/2	60	5	20,084	20,084	21,001	21,975
TFL-4896-G	96	48	29-1/2	60	5	21,429	21,429	22,377	23,383

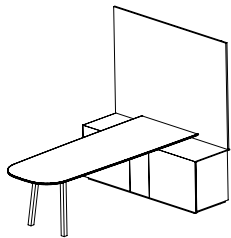

Shown with optional Monitor Panel (-MP)

OPTIONS	CODE	PRICE	NOTES
Power & Data Options			See pages 123-133
<b>Polished Chrome Finish Options:</b>			
Polished Chrome Open Frame Base	Add -PCOF-TWA	\$1,230	
<b>Satin Glass Options:</b>			
Satin Glass	Add -TFSG	\$635	
<b>Credenza Base Options:</b>			
60"-wide Monitor Panel	Add -MP	\$2,612	
Pull-out Waste/Recycling Unit (Left End Opening)	Add -TE	\$460	
Locks	Add -L	\$232	

## EDGE PROFILE

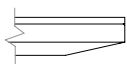

Two4Six Glass Edge

## GENERAL INFORMATION

- Tops are 1-1/8"-thick with 3/16"-thick hardwood edge band
- Seating capacity based on 27" per person
- Overall table height 29.5". Overall height 78" if Monitor Panel is specified.
- Standard with quarter cut veneer
- Pull-Out Waste/Recycling option is located on left side of unit if specified
- Adjustable shelves standard
- All doors will be keyed alike if locks are specified
- Lock color will default to metal color
- Access door on the credenza base standard with a lock
- Credenza base is 22"-deep, the Monitor Panel adds 2" making the depth 24"
- Plinth base is veneer and recessed 1" on all sides
- One section of wire management channel provided per table
- Pull-Out Waste/Recycling Bin size: 14" x 10-1/2" x 18"
- Only Woodgrain Laminate options are available for the Racetrack Base
- Racetrack Bases have a removable access door

### REQUIRED INFORMATION (ORDER CANNOT BE ENTERED WITHOUT THIS INFORMATION)

- See appendix pages vi-vii for surface material options.
- Choose Glass Finish
  - Choose Veneer Finish, if applicable
  - Choose Paint Finish if -PA is specified
  - Choose Metal Finish
  - Choose Sub-Top Finish: Paint Finish or Wood Species & Finish



# SOLID SURFACE TOP / VENEER CASE



D-SHAPE TOP

### BASE KEY

OF Open Frame

RCL Laminate Racetrack Base  
RCP Painted Racetrack Base  
RCV Veneer Racetrack Base

## D-SHAPE TOP // 60" CREDENZA BASE // SEATED HEIGHT

MODEL #	LENGTH	WIDTH	HEIGHT	CREDENZA BASE	SEATING CAPACITY	-OF	-RCL	-RCP	-RCV
TFL-3060-SS	60	30	29-1/2	60	3	14,027	-	-	-
TFL-3660-SS	60	36	29-1/2	60	3	14,346	-	-	-
TFL-4260-SS	60	42	29-1/2	60	3	15,947	-	-	-
TFL-4860-SS	60	48	29-1/2	60	3	16,856	-	-	-
TFL-3066-SS	66	30	29-1/2	60	3	15,019	-	-	-
TFL-3666-SS	66	36	29-1/2	60	3	15,389	-	-	-
TFL-4266-SS	66	42	29-1/2	60	3	17,138	-	-	-
TFL-4866-SS	66	48	29-1/2	60	3	18,146	-	-	-
TFL-3072-SS	72	30	29-1/2	60	3	15,230	-	-	-
TFL-3672-SS	72	36	29-1/2	60	3	15,634	-	-	-
TFL-4272-SS	72	42	29-1/2	60	3	17,441	17,441	18,294	19,197
TFL-4872-SS	72	48	29-1/2	60	3	18,498	18,498	19,380	20,314
TFL-3078-SS	78	30	29-1/2	60	5	16,512	-	-	-
TFL-3678-SS	78	36	29-1/2	60	5	16,980	-	-	-
TFL-4278-SS	78	42	29-1/2	60	5	18,977	18,977	19,888	20,855
TFL-4878-SS	78	48	29-1/2	60	5	20,159	20,159	21,101	22,100
TFL-3084-SS	84	30	29-1/2	60	5	16,739	-	-	-
TFL-3684-SS	84	36	29-1/2	60	5	17,243	-	-	-
TFL-4284-SS	84	42	29-1/2	60	5	19,300	19,300	20,212	21,179
TFL-4884-SS	84	48	29-1/2	60	5	20,534	20,534	21,477	22,477
TFL-3090-SS	90	30	29-1/2	60	5	17,846	-	-	-
TFL-3690-SS	90	36	29-1/2	60	5	18,415	-	-	-
TFL-4290-SS	90	42	29-1/2	60	5	20,644	20,644	21,603	22,620
TFL-4890-SS	90	48	29-1/2	60	5	21,994	21,994	22,987	24,038
TFL-3096-SS	96	30	29-1/2	60	5	18,084	-	-	-
TFL-3696-SS	96	36	29-1/2	60	5	18,690	-	-	-
TFL-4296-SS	96	42	29-1/2	60	5	20,985	20,985	21,944	22,961
TFL-4896-SS	96	48	29-1/2	60	5	22,390	22,390	23,381	24,433

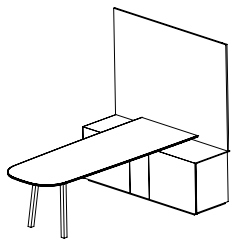

Shown with optional Monitor Panel (-MP)

### OPTIONS

Power & Data Options

See pages 123-133

#### Polished Chrome Finish Options:

Polished Chrome Open Frame Base Add **-PCOF-TWA** \$1,230

#### Credenza Base Options:

60"-wide Monitor Panel Add **-MP** \$2,612  
Pull-Out Waste/Recycling Unit (Left End Opening) Add **-TE** \$460  
Locks Add **-L** \$232

### EDGE PROFILE



Two4Six Solid Surface Edge

### GENERAL INFORMATION

- Seating capacity based on 27" per person
- Overall table height 29.5". Overall height 78" if Monitor Panel is specified.
- Standard with quarter cut veneer
- Pull-Out Waste/Recycling option is located on left side of unit if specified
- Adjustable shelves standard
- All doors will be keyed alike if locks are specified
- Lock color will default to metal color
- Access door on the credenza base standard with a lock
- Credenza base is 22"-deep, the Monitor Panel adds 2" making the depth 24"
- Plinth base is veneer and recessed 1" on all sides
- One section of wire management channel provided per table
- Pull-Out Waste/Recycling Bin size: 14" x 10-1/2" x 18"
- Only Woodgrain Laminate options are available for the Racetrack Base
- Racetrack Bases have a removable access door

### REQUIRED INFORMATION (ORDER CANNOT BE ENTERED WITHOUT THIS INFORMATION)

See appendix pages vi-vii for surface material options.

- Choose Solid Surface Finish
- Choose Veneer Finish, if applicable
- Choose Paint Finish if -PA is specified
- Choose Metal Finish



# VENEER TOP WITH HARDWOOD EDGE / VENEER CASE



D-SHAPE TOP

### BASE KEY

OF	Open Frame	RCL	Laminate Racetrack Base
ML	Post Metal Leg	RCP	Painted Racetrack Base
		RCV	Veneer Racetrack Base

## D-SHAPE TOP // 72" CREDENZA BASE // SEATED HEIGHT

MODEL #	LENGTH	WIDTH	HEIGHT	CREDENZA BASE	SEATING CAPACITY	-OF	-ML	-RCL	-RCP	-RCV
TFX-3060-V	60	30	29-1/2	72	3	8,998	8,998	-	-	-
TFX-3660-V	60	36	29-1/2	72	3	9,194	9,194	-	-	-
TFX-4260-V	60	42	29-1/2	72	3	10,211	10,211	-	-	-
TFX-4860-V	60	48	29-1/2	72	3	10,783	10,783	-	-	-
TFX-3066-V	66	30	29-1/2	72	3	9,629	9,629	-	-	-
TFX-3666-V	66	36	29-1/2	72	3	9,856	9,856	-	-	-
TFX-4266-V	66	42	29-1/2	72	3	10,965	10,965	-	-	-
TFX-4866-V	66	48	29-1/2	72	3	11,599	11,599	-	-	-
TFX-3072-V	72	30	29-1/2	72	3	9,758	9,758	-	-	-
TFX-3672-V	72	36	29-1/2	72	3	10,006	10,006	-	-	-
TFX-4272-V	72	42	29-1/2	72	3	11,151	11,151	11,151	11,696	12,325
TFX-4872-V	72	48	29-1/2	72	3	11,814	11,814	11,814	12,378	13,029
TFX-3078-V	78	30	29-1/2	72	5	10,574	10,574	-	-	-
TFX-3678-V	78	36	29-1/2	72	5	10,861	10,861	-	-	-
TFX-4278-V	78	42	29-1/2	72	5	12,124	12,124	12,124	12,707	13,380
TFX-4878-V	78	48	29-1/2	72	5	12,865	12,865	12,865	13,468	14,165
TFX-3084-V	84	30	29-1/2	72	5	10,713	10,713	-	-	-
TFX-3684-V	84	36	29-1/2	72	5	11,022	11,022	-	-	-
TFX-4284-V	84	42	29-1/2	72	5	12,323	12,323	12,323	12,906	13,579
TFX-4884-V	84	48	29-1/2	72	5	13,096	13,096	13,096	13,699	14,395
TFX-3090-V	90	30	29-1/2	72	5	11,415	11,415	-	-	-
TFX-3690-V	90	36	29-1/2	72	5	11,764	11,764	-	-	-
TFX-4290-V	90	42	29-1/2	72	5	13,172	13,172	13,172	13,785	14,493
TFX-4890-V	90	48	29-1/2	72	5	14,018	14,018	14,018	14,653	15,385
TFX-3096-V	96	30	29-1/2	72	5	11,560	11,560	-	-	-
TFX-3696-V	96	36	29-1/2	72	5	11,932	11,932	-	-	-
TFX-4296-V	96	42	29-1/2	72	5	13,381	13,381	13,381	13,994	14,703
TFX-4896-V	96	48	29-1/2	72	5	14,260	14,260	14,260	14,895	15,627

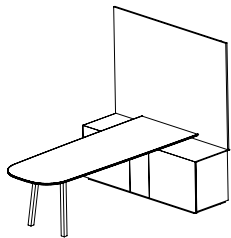

Shown with optional Monitor Panel (-MP)

### OPTIONS

Power & Data Options

See pages 123-133

#### Polished Chrome Finish Options:

Polished Chrome Open Frame Base	Add <b>-PCOF-TWA</b>	\$1,230
Polished Chrome Post Metal Legs	Add <b>-PCML-TWA</b>	\$567

#### Credenza Base Options:

72"-wide Monitor Panel	Add <b>-MP</b>	\$2,817
Pull-out Waste/Recycling Unit (Left End Opening)	Add <b>-TE</b>	\$460
Sliding Equipment Rack (Right End Opening)	Add <b>-R1</b>	\$3,322
Locks	Add <b>-L</b>	\$232

### EDGE PROFILE



Two4Six Cutback Edge

### GENERAL INFORMATION

- Tops are 1-1/8"-thick with 3/16"-thick hardwood edge band
- Seating capacity based on 27" per person
- Overall table height 29.5". Overall height 78" if Monitor Panel is specified.
- Standard with quarter cut veneer
- Pull-Out Waste/Recycling option is located on left side of unit if specified
- Sliding Equipment Rack is located on the right end of the unit if specified
- Adjustable shelves standard
- Access door on the credenza base standard with a lock
- All doors will be keyed alike if locks are specified
- Equipment Rack - 12RU with thermostatically controlled fan
- Thermostatically-controlled fan activates automatically at 87° F and turns off at 85° F
- Credenza base is 22"-deep, the Monitor Panel adds 2" making the depth 24"
- Plinth base is veneer and recessed 1" on all sides
- One section of wire management channel provided per table with Post Metal Leg and Open Frame Bases
- Pull-Out Waste/Recycling Bin size: 14" x 10-1/2" x 18"
- Only Woodgrain Laminate options are available for the Racetrack Base
- Racetrack Bases have a removable access door

#### REQUIRED INFORMATION (ORDER CANNOT BE ENTERED WITHOUT THIS INFORMATION)

See appendix pages vi-vii for surface material options.

- Choose Veneer Finish
- Choose Metal Finish, if -OF or -ML Base is specified (Clear Anodized (-CA) is an option on the Post Metal Leg only)





# INSET LAMINATE TOP WITH HARDWOOD EDGE / VENEER CASE



D-SHAPE TOP

**BASE KEY**

OF	Open Frame	RCL	Laminate Racetrack Base
ML	Post Metal Leg	RCP	Painted Racetrack Base
		RCV	Veneer Racetrack Base

**D-SHAPE TOP // 72" CREDENZA BASE // SEATED HEIGHT**

MODEL #	LENGTH	WIDTH	HEIGHT	CREDENZA BASE	SEATING CAPACITY	-OF	-ML	-RCL	-RCP	-RCV
TFX-3060-P	60	30	29-1/2	72	3	8,504	8,504	-	-	-
TFX-3660-P	60	36	29-1/2	72	3	8,689	8,689	-	-	-
TFX-4260-P	60	42	29-1/2	72	3	9,650	9,650	-	-	-
TFX-4860-P	60	48	29-1/2	72	3	10,190	10,190	-	-	-
TFX-3066-P	66	30	29-1/2	72	3	9,100	9,100	-	-	-
TFX-3666-P	66	36	29-1/2	72	3	9,314	9,314	-	-	-
TFX-4266-P	66	42	29-1/2	72	3	10,362	10,362	-	-	-
TFX-4866-P	66	48	29-1/2	72	3	10,962	10,962	-	-	-
TFX-3072-P	72	30	29-1/2	72	3	9,222	9,222	-	-	-
TFX-3672-P	72	36	29-1/2	72	3	9,456	9,456	-	-	-
TFX-4272-P	72	42	29-1/2	72	3	10,538	10,538	10,538	11,053	11,648
TFX-4872-P	72	48	29-1/2	72	3	11,165	11,165	11,165	11,698	12,313
TFX-3078-P	78	30	29-1/2	72	5	9,993	9,993	-	-	-
TFX-3678-P	78	36	29-1/2	72	5	10,264	10,264	-	-	-
TFX-4278-P	78	42	29-1/2	72	5	11,458	11,458	11,458	12,009	12,645
TFX-4878-P	78	48	29-1/2	72	5	12,158	12,158	12,158	12,728	13,386
TFX-3084-P	84	30	29-1/2	72	5	10,124	10,124	-	-	-
TFX-3684-P	84	36	29-1/2	72	5	10,416	10,416	-	-	-
TFX-4284-P	84	42	29-1/2	72	5	11,646	11,646	11,646	12,197	12,833
TFX-4884-P	84	48	29-1/2	72	5	12,376	12,376	12,376	12,946	13,604
TFX-3090-P	90	30	29-1/2	72	5	10,788	10,788	-	-	-
TFX-3690-P	90	36	29-1/2	72	5	11,117	11,117	-	-	-
TFX-4290-P	90	42	29-1/2	72	5	12,448	12,448	12,448	13,027	13,696
TFX-4890-P	90	48	29-1/2	72	5	13,248	13,248	13,248	13,848	14,539
TFX-3096-P	96	30	29-1/2	72	5	10,925	10,925	-	-	-
TFX-3696-P	96	36	29-1/2	72	5	11,276	11,276	-	-	-
TFX-4296-P	96	42	29-1/2	72	5	12,646	12,646	12,646	13,225	13,895
TFX-4896-P	96	48	29-1/2	72	5	13,476	13,476	13,476	14,076	14,768

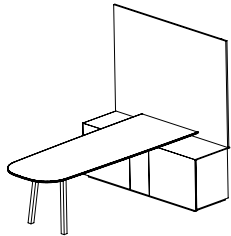

Shown with optional Monitor Panel (-MP)

**OPTIONS**

Power & Data Options

See pages 123-133

**Polished Chrome Finish Options:**

Polished Chrome Open Frame Base	Add <b>-PCOF-TWA</b>	\$1,230
Polished Chrome Post Metal Legs	Add <b>-PCML-TWA</b>	\$567

**Credenza Base Options:**

72"-wide Monitor Panel	Add <b>-MP</b>	\$2,817
Pull-out Waste/Recycling Unit (Left End Opening)	Add <b>-TE</b>	\$460
Sliding Equipment Rack (Right End Opening)	Add <b>-R1</b>	\$3,322
Locks	Add <b>-L</b>	\$232

**EDGE PROFILE**

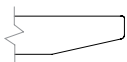

Two4Six Cutback Edge

**GENERAL INFORMATION**

- Tops are 1-1/8"-thick
- Seating capacity based on 27" per person
- Overall table height 29.5". Overall height 78" if Monitor Panel is specified.
- Standard with quarter cut veneer
- Pull-Out Waste/Recycling option is located on left side of unit if specified
- Sliding Equipment Rack is located on the right end of the unit if specified
- Adjustable shelves standard
- Access door on the credenza base standard with a lock
- All doors will be keyed alike if locks are specified
- Equipment Rack - 12RU with thermostatically controlled fan
- Thermostatically-controlled fan activates automatically at 87° F and turns off at 85° F
- Credenza base is 22"-deep, the Monitor Panel adds 2" making the depth 24"
- Plinth base is veneer and recessed 1" on all sides
- One section of wire management channel provided per table with Post Metal Leg and Open Frame Bases
- Pull-Out Waste/Recycling Bin size: 14" x 10-1/2" x 18"
- Only Woodgrain Laminate options are available for the Racetrack Base
- Racetrack Bases have a removable access door

**REQUIRED INFORMATION (ORDER CANNOT BE ENTERED WITHOUT THIS INFORMATION)**

See appendix pages vi-vii for surface material options.

- Choose Laminate Finish
- Choose Wood Species & Finish for Hardwood Edge
- Choose Veneer Finish
- Choose Metal Finish, if -OF or -ML Base is specified (Clear Anodized (-CA) is an option on the Post Metal Leg only)



# LAMINATE TOP WITH ABS CUTBACK EDGE / VENEER CASE



D-SHAPE TOP

**BASE KEY**

OF	Open Frame	RCL	Laminate Racetrack Base
ML	Post Metal Leg	RCP	Painted Racetrack Base
		RCV	Veneer Racetrack Base

**D-SHAPE TOP // 72" CREDENZA BASE // SEATED HEIGHT**

MODEL #	LENGTH	WIDTH	HEIGHT	CREDENZA BASE	SEATING CAPACITY	-OF	-ML	-RCL	-RCP	-RCV
TFX-3060-PA	60	30	29-1/2	72	3	8,504	8,504	-	-	-
TFX-3660-PA	60	36	29-1/2	72	3	8,689	8,689	-	-	-
TFX-4260-PA	60	42	29-1/2	72	3	9,650	9,650	-	-	-
TFX-4860-PA	60	48	29-1/2	72	3	10,190	10,190	-	-	-
TFX-3066-PA	66	30	29-1/2	72	3	9,100	9,100	-	-	-
TFX-3666-PA	66	36	29-1/2	72	3	9,314	9,314	-	-	-
TFX-4266-PA	66	42	29-1/2	72	3	10,362	10,362	-	-	-
TFX-4866-PA	66	48	29-1/2	72	3	10,962	10,962	-	-	-
TFX-3072-PA	72	30	29-1/2	72	3	9,222	9,222	-	-	-
TFX-3672-PA	72	36	29-1/2	72	3	9,456	9,456	-	-	-
TFX-4272-PA	72	42	29-1/2	72	3	10,538	10,538	10,538	11,053	11,648
TFX-4872-PA	72	48	29-1/2	72	3	11,165	11,165	11,165	11,698	12,313
TFX-3078-PA	78	30	29-1/2	72	5	9,993	9,993	-	-	-
TFX-3678-PA	78	36	29-1/2	72	5	10,264	10,264	-	-	-
TFX-4278-PA	78	42	29-1/2	72	5	11,458	11,458	11,458	12,009	12,645
TFX-4878-PA	78	48	29-1/2	72	5	12,158	12,158	12,158	12,728	13,386
TFX-3084-PA	84	30	29-1/2	72	5	10,124	10,124	-	-	-
TFX-3684-PA	84	36	29-1/2	72	5	10,416	10,416	-	-	-
TFX-4284-PA	84	42	29-1/2	72	5	11,646	11,646	11,646	12,197	12,833
TFX-4884-PA	84	48	29-1/2	72	5	12,376	12,376	12,376	12,946	13,604
TFX-3090-PA	90	30	29-1/2	72	5	10,788	10,788	-	-	-
TFX-3690-PA	90	36	29-1/2	72	5	11,117	11,117	-	-	-
TFX-4290-PA	90	42	29-1/2	72	5	12,448	12,448	12,448	13,027	13,696
TFX-4890-PA	90	48	29-1/2	72	5	13,248	13,248	13,248	13,848	14,539
TFX-3096-PA	96	30	29-1/2	72	5	10,925	10,925	-	-	-
TFX-3696-PA	96	36	29-1/2	72	5	11,276	11,276	-	-	-
TFX-4296-PA	96	42	29-1/2	72	5	12,646	12,646	12,646	13,225	13,895
TFX-4896-PA	96	48	29-1/2	72	5	13,476	13,476	13,476	14,076	14,768

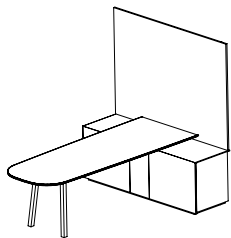

Shown with optional Monitor Panel (-MP)

**OPTIONS**

Power & Data Options

See pages 123-133

**Polished Chrome Finish Options:**

Polished Chrome Open Frame Base	Add -PCOF-TWA	\$1,230
Polished Chrome Post Metal Legs	Add -PCML-TWA	\$567

**Credenza Base Options:**

72"-wide Monitor Panel	Add -MP	\$2,817
Pull-out Waste/Recycling Unit (Left End Opening)	Add -TE	\$460
Sliding Equipment Rack (Right End Opening)	Add -R1	\$3,322
Locks	Add -L	\$232

**EDGE PROFILE**

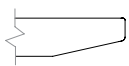

Two4Six Cutback Edge

**GENERAL INFORMATION**

- Tops are 1-1/8"-thick
- Seating capacity based on 27" per person
- Overall table height 29.5". Overall height 78" if Monitor Panel is specified.
- Standard with quarter cut veneer
- Pull-Out Waste/Recycling option is located on left side of unit if specified
- Sliding Equipment Rack is located on the right end of the unit if specified
- Adjustable shelves standard
- Access door on the credenza base standard with a lock
- All doors will be keyed alike if locks are specified
- Equipment Rack - 12RU with thermostatically controlled fan
- Thermostatically-controlled fan activates automatically at 87° F and turns off at 85° F
- Credenza base is 22"-deep, the Monitor Panel adds 2" making the depth 24"
- Plinth base is veneer and recessed 1" on all sides
- One section of wire management channel provided per table with Post Metal Leg and Open Frame Bases
- Pull-Out Waste/Recycling Bin size: 14" x 10-1/2" x 18"
- Only Woodgrain Laminate options are available for the Racetrack Base
- Racetrack Bases have a removable access door

**REQUIRED INFORMATION (ORDER CANNOT BE ENTERED WITHOUT THIS INFORMATION)**

See appendix pages vi-vii for surface material options.

- Choose Laminate Finish
- Choose ABS Edge Finish
- Choose Veneer Finish
- Choose Metal Finish, if -OF or -ML Base is specified (Clear Anodized (-CA) is an option on the Post Metal Leg only)



# LAMINATE TOP WITH ABS SQUARE EDGE / VENEER CASE



D-SHAPE TOP

**BASE KEY**

OF	Open Frame	RCL	Laminate Racetrack Base
ML	Post Metal Leg	RCP	Painted Racetrack Base
		RCV	Veneer Racetrack Base

**D-SHAPE TOP // 72" CREDENZA BASE // SEATED HEIGHT**

MODEL #	LENGTH	WIDTH	HEIGHT	CREDENZA BASE	SEATING CAPACITY	-OF	-ML	-RCL	-RCP	-RCV
TFX-3060-PE	60	30	29-1/2	72	3	8,081	8,081	-	-	-
TFX-3660-PE	60	36	29-1/2	72	3	8,257	8,257	-	-	-
TFX-4260-PE	60	42	29-1/2	72	3	9,170	9,170	-	-	-
TFX-4860-PE	60	48	29-1/2	72	3	9,684	9,684	-	-	-
TFX-3066-PE	66	30	29-1/2	72	3	8,647	8,647	-	-	-
TFX-3666-PE	66	36	29-1/2	72	3	8,851	8,851	-	-	-
TFX-4266-PE	66	42	29-1/2	72	3	9,847	9,847	-	-	-
TFX-4866-PE	66	48	29-1/2	72	3	10,416	10,416	-	-	-
TFX-3072-PE	72	30	29-1/2	72	3	8,763	8,763	-	-	-
TFX-3672-PE	72	36	29-1/2	72	3	8,986	8,986	-	-	-
TFX-4272-PE	72	42	29-1/2	72	3	10,014	10,014	10,014	10,504	11,068
TFX-4872-PE	72	48	29-1/2	72	3	10,609	10,609	10,609	11,116	11,701
TFX-3078-PE	78	30	29-1/2	72	5	9,496	9,496	-	-	-
TFX-3678-PE	78	36	29-1/2	72	5	9,754	9,754	-	-	-
TFX-4278-PE	78	42	29-1/2	72	5	10,888	10,888	10,888	11,411	12,016
TFX-4878-PE	78	48	29-1/2	72	5	11,553	11,553	11,553	12,095	12,721
TFX-3084-PE	84	30	29-1/2	72	5	9,621	9,621	-	-	-
TFX-3684-PE	84	36	29-1/2	72	5	9,898	9,898	-	-	-
TFX-4284-PE	84	42	29-1/2	72	5	11,067	11,067	11,067	11,590	12,194
TFX-4884-PE	84	48	29-1/2	72	5	11,761	11,761	11,761	12,302	12,927
TFX-3090-PE	90	30	29-1/2	72	5	10,251	10,251	-	-	-
TFX-3690-PE	90	36	29-1/2	72	5	10,565	10,565	-	-	-
TFX-4290-PE	90	42	29-1/2	72	5	11,829	11,829	11,829	12,379	13,015
TFX-4890-PE	90	48	29-1/2	72	5	12,589	12,589	12,589	13,159	13,816
TFX-3096-PE	96	30	29-1/2	72	5	10,381	10,381	-	-	-
TFX-3696-PE	96	36	29-1/2	72	5	10,715	10,715	-	-	-
TFX-4296-PE	96	42	29-1/2	72	5	12,017	12,017	12,017	12,567	13,204
TFX-4896-PE	96	48	29-1/2	72	5	12,806	12,806	12,806	13,376	14,034

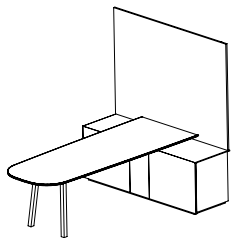

Shown with optional Monitor Panel (-MP)

**OPTIONS**

Power & Data Options

See pages 123-133

**Polished Chrome Finish Options:**

Polished Chrome Open Frame Base	Add <b>-PCOF-TWA</b>	\$1,230
Polished Chrome Post Metal Legs	Add <b>-PCML-TWA</b>	\$567

**Credenza Base Options:**

72"-wide Monitor Panel	Add <b>-MP</b>	\$2,817
Pull-out Waste/Recycling Unit (Left End Opening)	Add <b>-TE</b>	\$460
Sliding Equipment Rack (Right End Opening)	Add <b>-R1</b>	\$3,322
Locks	Add <b>-L</b>	\$232

**GENERAL INFORMATION**

- Tops are 1-1/8"-thick
- Seating capacity based on 27" per person
- Overall table height 29.5". Overall height 78" if Monitor Panel is specified.
- Standard with quarter cut veneer
- Pull-Out Waste/Recycling option is located on left side of unit if specified
- Sliding Equipment Rack is located on the right end of the unit if specified
- Adjustable shelves standard
- Access door on the credenza base standard with a lock
- All doors will be keyed alike if locks are specified
- Equipment Rack - 12RU with thermostatically controlled fan
- Thermostatically-controlled fan activates automatically at 87° F and turns off at 85° F
- Credenza base is 22"-deep, the Monitor Panel adds 2" making the depth 24"
- Plinth base is veneer and recessed 1" on all sides
- One section of wire management channel provided per table with Post Metal Leg and Open Frame Bases
- Pull-Out Waste/Recycling Bin size: 14" x 10-1/2" x 18"
- Only Woodgrain Laminate options are available for the Racetrack Base
- Racetrack Bases have a removable access door

**EDGE PROFILE**



Two4Six Square Edge

**REQUIRED INFORMATION (ORDER CANNOT BE ENTERED WITHOUT THIS INFORMATION)**

See appendix pages vi-vii for surface material options.

- Choose Laminate Finish
- Choose ABS Edge Finish
- Choose Veneer Finish
- Choose Metal Finish, if -OF or -ML Base is specified (Clear Anodized (-CA) is an option on the Post Metal Leg only)



# GLASS TOP / VENEER CASE



D-SHAPE TOP

### BASE KEY

OF Open Frame

RCL Laminate Racetrack Base  
RCP Painted Racetrack Base  
RCV Veneer Racetrack Base

## D-SHAPE TOP // 72" CREDENZA BASE // SEATED HEIGHT

MODEL #	LENGTH	WIDTH	HEIGHT	CREDENZA BASE	SEATING CAPACITY	-OF	-RCL	-RCP	-RCV
TFX-3060-G	60	30	29-1/2	72	3	14,037	-	-	-
TFX-3660-G	60	36	29-1/2	72	3	14,343	-	-	-
TFX-4260-G	60	42	29-1/2	72	3	15,930	-	-	-
TFX-4860-G	60	48	29-1/2	72	3	16,822	-	-	-
TFX-3066-G	66	30	29-1/2	72	3	15,022	-	-	-
TFX-3666-G	66	36	29-1/2	72	3	15,376	-	-	-
TFX-4266-G	66	42	29-1/2	72	3	17,106	-	-	-
TFX-4866-G	66	48	29-1/2	72	3	18,095	-	-	-
TFX-3072-G	72	30	29-1/2	72	3	15,223	-	-	-
TFX-3672-G	72	36	29-1/2	72	3	15,610	-	-	-
TFX-4272-G	72	42	29-1/2	72	3	17,396	17,396	18,246	19,227
TFX-4872-G	72	48	29-1/2	72	3	18,430	18,430	19,310	20,326
TFX-3078-G	78	30	29-1/2	72	5	16,496	-	-	-
TFX-3678-G	78	36	29-1/2	72	5	16,944	-	-	-
TFX-4278-G	78	42	29-1/2	72	5	18,914	18,914	19,823	20,873
TFX-4878-G	78	48	29-1/2	72	5	20,070	20,070	21,011	22,098
TFX-3084-G	84	30	29-1/2	72	5	16,713	-	-	-
TFX-3684-G	84	36	29-1/2	72	5	17,195	-	-	-
TFX-4284-G	84	42	29-1/2	72	5	19,224	19,224	20,134	21,184
TFX-4884-G	84	48	29-1/2	72	5	20,430	20,430	21,371	22,457
TFX-3090-G	90	30	29-1/2	72	5	17,808	-	-	-
TFX-3690-G	90	36	29-1/2	72	5	18,352	-	-	-
TFX-4290-G	90	42	29-1/2	72	5	20,549	20,549	21,505	22,610
TFX-4890-G	90	48	29-1/2	72	5	21,869	21,869	22,859	24,001
TFX-3096-G	96	30	29-1/2	72	5	18,034	-	-	-
TFX-3696-G	96	36	29-1/2	72	5	18,614	-	-	-
TFX-4296-G	96	42	29-1/2	72	5	20,875	20,875	21,831	22,937
TFX-4896-G	96	48	29-1/2	72	5	22,246	22,246	23,237	24,379

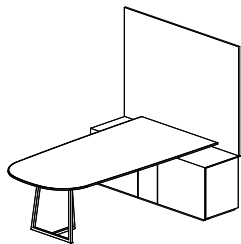

Shown with optional Monitor Panel (-MP)

### OPTIONS

Power & Data Options

See pages 123-133

#### Polished Chrome Finish Options:

Polished Chrome Open Frame Base Add **-PCOF-TWA** \$1,230

#### Satin Glass Options:

Satin Glass Add **-TFSG** \$635

#### Credenza Base Options:

72"-wide Monitor Panel Add **-MP** \$2,817  
 Pull-out Waste/Recycling Unit (Left End Opening) Add **-TE** \$460  
 Sliding Equipment Rack (Right End Opening) Add **-R1** \$3,322  
 Locks Add **-L** \$232

### EDGE PROFILE



Two4Six Glass Edge

### GENERAL INFORMATION

- Tops are 1-1/8" -thick
- Seating capacity based on 27" per person
- Overall table height 29.5". Overall height 78" if Monitor Panel is specified.
- Standard with quarter cut veneer
- Pull-Out Waste/Recycling option is located on left side of unit if specified
- Sliding Equipment Rack is located on the right end of the unit if specified
- Adjustable shelves standard
- Access door on the credenza base standard with a lock
- All doors will be keyed alike if locks are specified
- Equipment Rack - 12RU with thermostatically controlled fan
- Thermostatically-controlled fan activates automatically at 87° F and turns off at 85° F
- Credenza base is 22"-deep, the Monitor Panel adds 2" making the depth 24"
- Plinth base is veneer and recessed 1" on all sides
- One section of wire management channel provided per table with Post Metal Leg and Open Frame Bases
- Pull-Out Waste/Recycling Bin size: 14" x 10-1/2" x 18"
- Only Woodgrain Laminate options are available for the Racetrack Base
- Racetrack Bases have a removable access door

### REQUIRED INFORMATION (ORDER CANNOT BE ENTERED WITHOUT THIS INFORMATION)

See appendix pages vi-vii for surface material options.

- Choose Glass Finish
- Choose Veneer Finish, if applicable
- Choose Paint Finish if -PA is specified
- Choose Metal Finish
- Choose Sub-Top Finish: Paint Finish or Wood Species & Finish



# SOLID SURFACE TOP / VENEER CASE



D-SHAPE TOP

### BASE KEY

OF Open Frame

RCL Laminate Racetrack Base

RCP Painted Racetrack Base

RCV Veneer Racetrack Base

## D-SHAPE TOP // 72" CREENZA BASE // SEATED HEIGHT

MODEL #	LENGTH	WIDTH	HEIGHT	CREENZA BASE	SEATING CAPACITY	-OF	-RCL	-RCP	-RCV
TFX-3060-SS	60	30	29-1/2	72	3	14,667	-	-	-
TFX-3660-SS	60	36	29-1/2	72	3	14,987	-	-	-
TFX-4260-SS	60	42	29-1/2	72	3	16,644	-	-	-
TFX-4860-SS	60	48	29-1/2	72	3	17,577	-	-	-
TFX-3066-SS	66	30	29-1/2	72	3	15,696	-	-	-
TFX-3666-SS	66	36	29-1/2	72	3	16,066	-	-	-
TFX-4266-SS	66	42	29-1/2	72	3	17,873	-	-	-
TFX-4866-SS	66	48	29-1/2	72	3	18,907	-	-	-
TFX-3072-SS	72	30	29-1/2	72	3	15,906	-	-	-
TFX-3672-SS	72	36	29-1/2	72	3	16,310	-	-	-
TFX-4272-SS	72	42	29-1/2	72	3	18,177	18,177	19,065	20,090
TFX-4872-SS	72	48	29-1/2	72	3	19,257	19,257	20,177	21,238
TFX-3078-SS	78	30	29-1/2	72	5	17,236	-	-	-
TFX-3678-SS	78	36	29-1/2	72	5	17,704	-	-	-
TFX-4278-SS	78	42	29-1/2	72	5	19,763	19,763	20,713	21,810
TFX-4878-SS	78	48	29-1/2	72	5	20,970	20,970	21,953	23,089
TFX-3084-SS	84	30	29-1/2	72	5	17,463	-	-	-
TFX-3684-SS	84	36	29-1/2	72	5	17,966	-	-	-
TFX-4284-SS	84	42	29-1/2	72	5	20,087	20,087	21,037	22,134
TFX-4884-SS	84	48	29-1/2	72	5	21,347	21,347	22,330	23,464
TFX-3090-SS	90	30	29-1/2	72	5	18,607	-	-	-
TFX-3690-SS	90	36	29-1/2	72	5	19,176	-	-	-
TFX-4290-SS	90	42	29-1/2	72	5	21,471	21,471	22,470	23,624
TFX-4890-SS	90	48	29-1/2	72	5	22,850	22,850	23,885	25,078
TFX-3096-SS	96	30	29-1/2	72	5	18,843	-	-	-
TFX-3696-SS	96	36	29-1/2	72	5	19,450	-	-	-
TFX-4296-SS	96	42	29-1/2	72	5	21,812	21,812	22,811	23,966
TFX-4896-SS	96	48	29-1/2	72	5	23,244	23,244	24,279	25,473

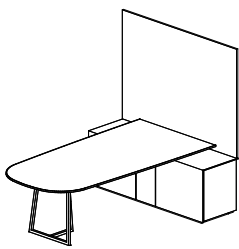

Shown with optional Monitor Panel (-MP)

### OPTIONS

Power & Data Options

### CODE

### PRICE

### NOTES

See pages 123-133

#### Polished Chrome Finish Options:

Polished Chrome Open Frame Base

Add **-PCOF-TWA** \$1,230

#### CreENZA Base Options:

- 72"-wide Monitor Panel
- Pull-out Waste/Recycling Unit (Left End Opening)
- Sliding Equipment Rack (Right End Opening)
- Locks

Add **-MP** \$2,817  
 Add **-TE** \$460  
 Add **-R1** \$3,322  
 Add **-L** \$232

### EDGE PROFILE



Two4Six Solid Surface Edge

### GENERAL INFORMATION

- Seating capacity based on 27" per person
- Overall table height 29.5". Overall height 78" if Monitor Panel is specified.
- Standard with quarter cut veneer
- Pull-Out Waste/Recycling option is located on left side of unit if specified
- Sliding Equipment Rack is located on the right end of the unit if specified
- Adjustable shelves standard
- Access door on the creENZA base standard with a lock.
- All doors will be keyed alike if locks are specified.
- Equipment Rack - 12RU with thermostatically controlled fan
- Thermostatically-controlled fan activates automatically at 87° F and turns off at 85° F
- CreENZA base is 22"-deep, the Monitor Panel adds 2" making the depth 4"
- Plinth base is veneer and recessed 1" on all sides
- One section of wire management channel provided per table with Post Metal Leg and Open Frame Bases
- Pull-Out Waste/Recycling Bin size: 14" x 10-1/2" x 18"
- Only Woodgrain Laminate options are available for the Racetrack Base
- Racetrack Bases have a removable access door

#### REQUIRED INFORMATION (ORDER CANNOT BE ENTERED WITHOUT THIS INFORMATION)

See appendix pages vi-vii for surface material options.

- Choose Solid Surface Finish
- Choose Veneer Finish, if applicable
- Choose Paint Finish if -PA is specified
- Choose Metal Finish



# VENEER TOP WITH HARDWOOD EDGE



D-SHAPE TOP

### BASE KEY

OF	Open Frame	RCL	Laminate Racetrack Base
ML	Post Metal Leg	RCP	Painted Racetrack Base
		RCV	Veneer Racetrack Base

### D-SHAPE TOP // SLAB BASE // SEATED HEIGHT

MODEL #	LENGTH	WIDTH	HEIGHT	SEATING CAPACITY	-OF	-ML	-RCL	-RCP	-RCV
TFE-3060-V [ ]	60	30	29-1/2	4	3,779	3,779	-	-	-
TFE-3066-V [ ]	66	30	29-1/2	5	4,119	4,119	-	-	-
TFE-3072-V [ ]	72	30	29-1/2	5	4,248	4,248	-	-	-
TFE-3078-V [ ]	78	30	29-1/2	5	4,682	4,682	-	-	-
TFE-3084-V [ ]	84	30	29-1/2	7	4,821	4,821	-	-	-
TFE-3090-V [ ]	90	30	29-1/2	7	5,217	5,217	-	-	-
TFE-3096-V [ ]	96	30	29-1/2	7	5,362	5,362	-	-	-
TFE-3660-V [ ]	60	36	29-1/2	5	3,975	3,975	-	-	-
TFE-3666-V [ ]	66	36	29-1/2	5	4,346	4,346	-	-	-
TFE-3672-V [ ]	72	36	29-1/2	5	4,496	4,496	-	-	-
TFE-3678-V [ ]	78	36	29-1/2	5	4,969	4,969	-	-	-
TFE-3684-V [ ]	84	36	29-1/2	7	5,130	5,130	-	-	-
TFE-3690-V [ ]	90	36	29-1/2	7	5,566	5,566	-	-	-
TFE-3696-V [ ]	96	36	29-1/2	7	5,734	5,734	-	-	-
TFE-4260-V [ ]	60	42	29-1/2	5	4,535	4,535	-	-	-
TFE-4266-V [ ]	66	42	29-1/2	5	4,974	4,974	-	-	-
TFE-4272-V [ ]	72	42	29-1/2	5	5,159	5,159	5,159	5,401	5,673
TFE-4278-V [ ]	78	42	29-1/2	5	5,717	5,717	5,717	5,975	6,266
TFE-4284-V [ ]	84	42	29-1/2	7	5,915	5,915	5,915	6,173	6,465
TFE-4290-V [ ]	90	42	29-1/2	7	6,432	6,432	6,432	6,703	7,010
TFE-4296-V [ ]	96	42	29-1/2	7	6,641	6,641	6,641	6,912	7,219
TFE-4860-V [ ]	60	48	29-1/2	5	4,912	4,912	-	-	-
TFE-4866-V [ ]	66	48	29-1/2	5	5,401	5,401	-	-	-
TFE-4872-V [ ]	72	48	29-1/2	5	5,616	5,616	5,616	5,866	6,148
TFE-4878-V [ ]	78	48	29-1/2	7	6,237	6,237	6,237	6,504	6,805
TFE-4884-V [ ]	84	48	29-1/2	7	6,467	6,467	6,467	6,734	7,036
TFE-4890-V [ ]	90	48	29-1/2	7	7,045	7,045	7,045	7,326	7,643
TFE-4896-V [ ]	96	48	29-1/2	7	7,288	7,288	7,288	7,568	7,885

[ ] Slab Base, Specify Paint (-PS) or Veneer (-V)

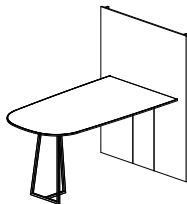

Shown with optional Monitor Panel (-MP)

### OPTIONS

OPTIONS	CODE	PRICE	NOTES
Power & Data Options			See pages 123-133
Remove Slab Base	Add <b>-WM</b>	Deduct \$672	Mounted directly to wall
<b>Polished Chrome Finish Options:</b>			
Polished Chrome Open Frame Base	Add <b>-PCOF-TWA</b>	\$1,230	
Polished Chrome Post Metal Legs	Add <b>-PCML-TWA</b>	\$567	
<b>Monitor Panel Options:</b>			
42"-Wide Monitor Panel	Add <b>-MP30</b>	\$1,996	For use with 30"-Wide Tables
48"-Wide Monitor Panel	Add <b>-MP36</b>	\$2,200	For use with 36"-Wide Tables
54"-Wide Monitor Panel	Add <b>-MP42</b>	\$2,405	For use with 42"-Wide Tables
60"-Wide Monitor Panel	Add <b>-MP48</b>	\$2,612	For use with 48"-Wide Tables

### EDGE PROFILE

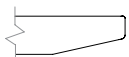

Two4Six Cutback Edge

### GENERAL INFORMATION

- Tops are 1-1/8" -thick with 3/16" -thick hardwood edge band
- Seating capacity based on 27" per person
- Overall table height 29.5"
- Standard with quarter cut veneer
- Must be anchored to a wall, with or without Slab Base
- One section of wire management channel provided per table with Post Metal Leg and Open Frame Bases
- Monitor Panel will be 12" wider than the table specified
- Monitor Panel mounts directly to the wall
- Monitor Panel is 78" high
- Only Woodgrain Laminate options are available for the Racetrack Base
- Racetrack Bases have a removable access door

### REQUIRED INFORMATION (ORDER CANNOT BE ENTERED WITHOUT THIS INFORMATION)

- See appendix pages vi-vii for surface material options.
- Choose Veneer Finish. If -V option is specified for the Slab Base, the finish will be the same as the table top.
  - Choose Paint Finish, if -PS Slab Base is specified
  - Choose Metal Finish, if -OF or -ML Base is specified (Clear Anodized (-CA) is an option on the Post Metal Leg only)



# INSET LAMINATE TOP WITH HARDWOOD EDGE



D-SHAPE TOP

### BASE KEY

OF	Open Frame	RCL	Laminate Racetrack Base
ML	Post Metal Leg	RCP	Painted Racetrack Base
		RCV	Veneer Racetrack Base

## D-SHAPE TOP // SLAB BASE // SEATED HEIGHT

MODEL #	LENGTH	WIDTH	HEIGHT	SEATING CAPACITY	-OF	-ML	-RCL	-RCP	-RCV
TFE-3060-P [ ]	60	30	29-1/2	4	3,572	3,572	-	-	-
TFE-3066-P [ ]	66	30	29-1/2	5	3,893	3,893	-	-	-
TFE-3072-P [ ]	72	30	29-1/2	5	4,015	4,015	-	-	-
TFE-3078-P [ ]	78	30	29-1/2	5	4,425	4,425	-	-	-
TFE-3084-P [ ]	84	30	29-1/2	7	4,556	4,556	-	-	-
TFE-3090-P [ ]	90	30	29-1/2	7	4,931	4,931	-	-	-
TFE-3096-P [ ]	96	30	29-1/2	7	5,068	5,068	-	-	-
TFE-3660-P [ ]	60	36	29-1/2	5	3,757	3,757	-	-	-
TFE-3666-P [ ]	66	36	29-1/2	5	4,107	4,107	-	-	-
TFE-3672-P [ ]	72	36	29-1/2	5	4,249	4,249	-	-	-
TFE-3678-P [ ]	78	36	29-1/2	5	4,696	4,696	-	-	-
TFE-3684-P [ ]	84	36	29-1/2	7	4,848	4,848	-	-	-
TFE-3690-P [ ]	90	36	29-1/2	7	5,260	5,260	-	-	-
TFE-3696-P [ ]	96	36	29-1/2	7	5,419	5,419	-	-	-
TFE-4260-P [ ]	60	42	29-1/2	5	4,286	4,286	-	-	-
TFE-4266-P [ ]	66	42	29-1/2	5	4,701	4,701	-	-	-
TFE-4272-P [ ]	72	42	29-1/2	5	4,876	4,876	4,876	5,104	5,361
TFE-4278-P [ ]	78	42	29-1/2	5	5,403	5,403	5,403	5,647	5,922
TFE-4284-P [ ]	84	42	29-1/2	7	5,590	5,590	5,590	5,834	6,110
TFE-4290-P [ ]	90	42	29-1/2	7	6,079	6,079	6,079	6,335	6,625
TFE-4296-P [ ]	96	42	29-1/2	7	6,276	6,276	6,276	6,532	6,822
TFE-4860-P [ ]	60	48	29-1/2	5	4,642	4,642	-	-	-
TFE-4866-P [ ]	66	48	29-1/2	5	5,104	5,104	-	-	-
TFE-4872-P [ ]	72	48	29-1/2	5	5,308	5,308	5,308	5,544	5,810
TFE-4878-P [ ]	78	48	29-1/2	7	5,894	5,894	5,894	6,147	6,431
TFE-4884-P [ ]	84	48	29-1/2	7	6,112	6,112	6,112	6,364	6,650
TFE-4890-P [ ]	90	48	29-1/2	7	6,658	6,658	6,658	6,924	7,223
TFE-4896-P [ ]	96	48	29-1/2	7	6,888	6,888	6,888	7,152	7,452

[ ] Slab Base, Specify Paint (-PS) or Veneer (-V)

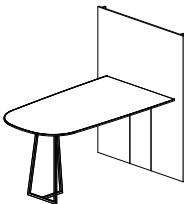

Shown with optional Monitor Panel (-MP)

### OPTIONS

Power & Data Options

See pages 123-133

Remove Slab Base

Add **-WM**

Deduct \$672

Mounted directly to wall

### Polished Chrome Finish Options:

Polished Chrome Open Frame Base

Add **-PCOF-TWA**

\$1,230

Polished Chrome Post Metal Legs

Add **-PCML-TWA**

\$567

### Monitor Panel Options:

42"-Wide Monitor Panel

Add **-MP30**

\$1,996

For use with 30"-Wide Tables

48"-Wide Monitor Panel

Add **-MP36**

\$2,200

For use with 36"-Wide Tables

54"-Wide Monitor Panel

Add **-MP42**

\$2,405

For use with 42"-Wide Tables

60"-Wide Monitor Panel

Add **-MP48**

\$2,612

For use with 48"-Wide Tables

### EDGE PROFILE

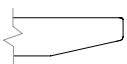

Two4Six Cutback Edge

### GENERAL INFORMATION

- Tops are 1-1/8"-thick with 3/16"-thick hardwood edge band
- Seating capacity based on 27" per person
- Overall table height 29.5"
- Standard with quarter cut veneer
- Must be anchored to a wall, with or without Slab Base
- One section of wire management channel provided per table with Post Metal Leg and Open Frame Bases
- Monitor Panel will be 12" wider than the table specified
- Monitor Panel mounts directly to the wall
- Monitor Panel is 78" high
- Monitor panel available in Paint or Veneer Finish options only
- Only Woodgrain Laminate options are available for the Racetrack Base
- Racetrack Bases have a removable access door

### REQUIRED INFORMATION (ORDER CANNOT BE ENTERED WITHOUT THIS INFORMATION)

See appendix pages vi-vii for surface material options.

- Choose Laminate Finish
- Choose Wood Species & Finish for Hardwood Edge
- Choose Paint Finish, if -PS Slab Base is specified
- Choose Veneer Finish, if -V Slab Base is specified
- Choose Metal Finish, if -OF or -ML Base is specified (Clear Anodized (-CA) is an option on the Post Metal Leg only)



# LAMINATE TOP WITH ABS CUTBACK EDGE



D-SHAPE TOP

### BASE KEY

OF	Open Frame	RCL	Laminate Racetrack Base
ML	Post Metal Leg	RCP	Painted Racetrack Base
		RCV	Veneer Racetrack Base

## D-SHAPE TOP // SLAB BASE // SEATED HEIGHT

MODEL #	LENGTH	WIDTH	HEIGHT	SEATING CAPACITY	-OF	-ML	-RCL	-RCP	-RCV
TFE-3060-PA [ ]	60	30	29-1/2	5	3,572	3,572	-	-	-
TFE-3066-PA [ ]	66	30	29-1/2	5	3,893	3,893	-	-	-
TFE-3072-PA [ ]	72	30	29-1/2	5	4,015	4,015	-	-	-
TFE-3078-PA [ ]	78	30	29-1/2	5	4,425	4,425	-	-	-
TFE-3084-PA [ ]	84	30	29-1/2	7	4,556	4,556	-	-	-
TFE-3090-PA [ ]	90	30	29-1/2	7	4,931	4,931	-	-	-
TFE-3096-PA [ ]	96	30	29-1/2	7	5,068	5,068	-	-	-
TFE-3660-PA [ ]	60	36	29-1/2	5	3,757	3,757	-	-	-
TFE-3666-PA [ ]	66	36	29-1/2	5	4,107	4,107	-	-	-
TFE-3672-PA [ ]	72	36	29-1/2	5	4,249	4,249	-	-	-
TFE-3678-PA [ ]	78	36	29-1/2	5	4,696	4,696	-	-	-
TFE-3684-PA [ ]	84	36	29-1/2	7	4,848	4,848	-	-	-
TFE-3690-PA [ ]	90	36	29-1/2	7	5,260	5,260	-	-	-
TFE-3696-PA [ ]	96	36	29-1/2	7	5,419	5,419	-	-	-
TFE-4260-PA [ ]	60	42	29-1/2	5	4,286	4,286	-	-	-
TFE-4266-PA [ ]	66	42	29-1/2	5	4,701	4,701	-	-	-
TFE-4272-PA [ ]	72	42	29-1/2	5	4,876	4,876	4,876	5,104	5,361
TFE-4278-PA [ ]	78	42	29-1/2	5	5,403	5,403	5,403	5,647	5,922
TFE-4284-PA [ ]	84	42	29-1/2	7	5,590	5,590	5,590	5,834	6,110
TFE-4290-PA [ ]	90	42	29-1/2	7	6,079	6,079	6,079	6,335	6,625
TFE-4296-PA [ ]	96	42	29-1/2	7	6,276	6,276	6,276	6,532	6,822
TFE-4860-PA [ ]	60	48	29-1/2	5	4,642	4,642	-	-	-
TFE-4866-PA [ ]	66	48	29-1/2	5	5,104	5,104	-	-	-
TFE-4872-PA [ ]	72	48	29-1/2	5	5,308	5,308	5,308	5,544	5,810
TFE-4878-PA [ ]	78	48	29-1/2	5	5,894	5,894	5,894	6,147	6,431
TFE-4884-PA [ ]	84	48	29-1/2	7	6,112	6,112	6,112	6,364	6,650
TFE-4890-PA [ ]	90	48	29-1/2	7	6,658	6,658	6,658	6,924	7,223
TFE-4896-PA [ ]	96	48	29-1/2	7	6,888	6,888	6,888	7,152	7,452

[ ] Slab Base, Specify Paint (-PS) or Veneer (-V)

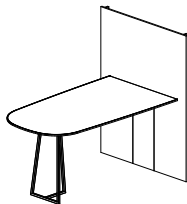

Shown with optional Monitor Panel (-MP)

### OPTIONS

	CODE	PRICE	NOTES
Power & Data Options			See pages 123-133
Remove Slab Base	Add <b>-WM</b>	Deduct \$672	Mounted directly to wall
<b>Polished Chrome Finish Options:</b>			
Polished Chrome Open Frame Base	Add <b>-PCOF-TWA</b>	\$1,230	
Polished Chrome Post Metal Legs	Add <b>-PCML-TWA</b>	\$567	
<b>Monitor Panel Options:</b>			
42"-Wide Monitor Panel	Add <b>-MP30</b>	\$1,996	For use with 30"-Wide Tables
48"-Wide Monitor Panel	Add <b>-MP36</b>	\$2,200	For use with 36"-Wide Tables
54"-Wide Monitor Panel	Add <b>-MP42</b>	\$2,405	For use with 42"-Wide Tables
60"-Wide Monitor Panel	Add <b>-MP48</b>	\$2,612	For use with 48"-Wide Tables

### EDGE PROFILE

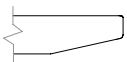

Two4Six Cutback Edge

### GENERAL INFORMATION

- Tops are 1-1/8"-thick with 3/16"-thick hardwood edge band
- Seating capacity based on 27" per person
- Overall table height 29.5"
- Standard with quarter cut veneer
- Must be anchored to a wall, with or without Slab Base
- One section of wire management channel provided per table with Post Metal Leg and Open Frame Bases
- Monitor Panel will be 12" wider than the table specified
- Monitor Panel mounts directly to the wall
- Monitor Panel is 78" high
- Monitor panel available in Paint or Veneer Finish options only
- Only Woodgrain Laminate options are available for the Racetrack Base
- Racetrack Bases have a removable access door

### REQUIRED INFORMATION (ORDER CANNOT BE ENTERED WITHOUT THIS INFORMATION)

See appendix pages vi-vii for surface material options.

- Choose Laminate Finish
- Choose ABS Edge Finish
- Choose Paint Finish, if -PS Slab Base is specified
- Choose Veneer Finish, if -V Slab Base is specified
- Choose Metal Finish, if -OF or -ML Base is specified (Clear Anodized (-CA) is an option on the Post Metal Leg only)





# LAMINATE TOP WITH ABS SQUARE EDGE



D-SHAPE TOP

**BASE KEY**

OF	Open Frame	RCL	Laminate Racetrack Base
ML	Post Metal Leg	RCP	Painted Racetrack Base
		RCV	Veneer Racetrack Base

**D-SHAPE TOP // SLAB BASE // SEATED HEIGHT**

MODEL #	LENGTH	WIDTH	HEIGHT	SEATING CAPACITY	-OF	-ML	-RCL	-RCP	-RCV
TFE-3060-PE [ ]	60	30	29-1/2	4	3,394	3,394	-	-	-
TFE-3066-PE [ ]	66	30	29-1/2	5	3,699	3,699	-	-	-
TFE-3072-PE [ ]	72	30	29-1/2	5	3,815	3,815	-	-	-
TFE-3078-PE [ ]	78	30	29-1/2	5	4,205	4,205	-	-	-
TFE-3084-PE [ ]	84	30	29-1/2	7	4,330	4,330	-	-	-
TFE-3090-PE [ ]	90	30	29-1/2	7	4,685	4,685	-	-	-
TFE-3096-PE [ ]	96	30	29-1/2	7	4,816	4,816	-	-	-
TFE-3660-PE [ ]	60	36	29-1/2	5	3,570	3,570	-	-	-
TFE-3666-PE [ ]	66	36	29-1/2	5	3,903	3,903	-	-	-
TFE-3672-PE [ ]	72	36	29-1/2	5	4,038	4,038	-	-	-
TFE-3678-PE [ ]	78	36	29-1/2	5	4,463	4,463	-	-	-
TFE-3684-PE [ ]	84	36	29-1/2	7	4,607	4,607	-	-	-
TFE-3690-PE [ ]	90	36	29-1/2	7	4,999	4,999	-	-	-
TFE-3696-PE [ ]	96	36	29-1/2	7	5,150	5,150	-	-	-
TFE-4260-PE [ ]	60	42	29-1/2	5	4,073	4,073	-	-	-
TFE-4266-PE [ ]	66	42	29-1/2	5	4,467	4,467	-	-	-
TFE-4272-PE [ ]	72	42	29-1/2	5	4,633	4,633	4,633	4,851	5,095
TFE-4278-PE [ ]	78	42	29-1/2	5	5,134	5,134	5,134	5,366	5,627
TFE-4284-PE [ ]	84	42	29-1/2	7	5,312	5,312	5,312	5,544	5,806
TFE-4290-PE [ ]	90	42	29-1/2	7	5,776	5,776	5,776	6,020	6,295
TFE-4296-PE [ ]	96	42	29-1/2	7	5,964	5,964	5,964	6,207	6,483
TFE-4860-PE [ ]	60	48	29-1/2	5	4,411	4,411	-	-	-
TFE-4866-PE [ ]	66	48	29-1/2	5	4,851	4,851	-	-	-
TFE-4872-PE [ ]	72	48	29-1/2	5	5,044	5,044	5,044	5,268	5,521
TFE-4878-PE [ ]	78	48	29-1/2	7	5,601	5,601	5,601	5,841	6,111
TFE-4884-PE [ ]	84	48	29-1/2	7	5,808	5,808	5,808	6,048	6,319
TFE-4890-PE [ ]	90	48	29-1/2	7	6,327	6,327	6,327	6,579	6,864
TFE-4896-PE [ ]	96	48	29-1/2	7	6,545	6,545	6,545	6,797	7,081

[ ] Slab Base, Specify Paint (-PS) or Veneer (-V)

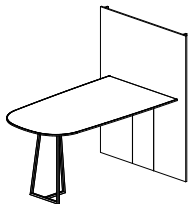

Shown with optional Monitor Panel (-MP)

**OPTIONS**

	CODE	PRICE	NOTES
Power & Data Options			See pages 123-133
Remove Slab Base	Add <b>-WM</b>	Deduct \$672	Mounted directly to wall
<b>Polished Chrome Finish Options:</b>			
Polished Chrome Open Frame Base	Add <b>-PCOF-TWA</b>	\$1,230	
Polished Chrome Post Metal Legs	Add <b>-PCML-TWA</b>	\$567	
<b>Monitor Panel Options:</b>			
42"-Wide Monitor Panel	Add <b>-MP30</b>	\$1,996	For use with 30"-Wide Tables
48"-Wide Monitor Panel	Add <b>-MP36</b>	\$2,200	For use with 36"-Wide Tables
54"-Wide Monitor Panel	Add <b>-MP42</b>	\$2,405	For use with 42"-Wide Tables
60"-Wide Monitor Panel	Add <b>-MP48</b>	\$2,612	For use with 48"-Wide Tables

**EDGE PROFILE**



Two4Six Square Edge

**GENERAL INFORMATION**

- Tops are 1-1/8"-thick
- Seating capacity based on 27" per person
- Overall table height 29.5"
- Standard with quarter cut veneer
- Must be anchored to a wall, with or without Slab Base
- One section of wire management channel provided per table with Post Metal Leg and Open Frame Bases
- Monitor Panel will be 12" wider than the table specified
- Monitor Panel mounts directly to the wall
- Monitor Panel is 78" high
- Monitor panel available in Paint or Veneer Finish options only
- Only Woodgrain Laminate options are available for the Racetrack Base
- Racetrack Bases have a removable access door

**REQUIRED INFORMATION (ORDER CANNOT BE ENTERED WITHOUT THIS INFORMATION)**

See appendix pages vi-vii for surface material options.

- Choose Laminate Finish
  - Choose ABS Edge Finish
  - Choose Paint Finish, if -PS Slab Base is specified
  - Choose Veneer Finish, if -V Slab Base is specified
- Choose Metal Finish, if -OF or -ML Base is specified (Clear Anodized (-CA) is an option on the Post Metal Leg only)



# GLASS TOP



D-SHAPE TOP

### BASE KEY

OF	Open Frame	RCL	Laminate Racetrack Base
		RCP	Painted Racetrack Base
		RCV	Veneer Racetrack Base

## D-SHAPE TOP // SLAB BASE // SEATED HEIGHT

MODEL #	LENGTH	WIDTH	HEIGHT	SEATING CAPACITY	-OF	-RCL	-RCP	-RCV
TFE-3060-G [ ]	60	30	29-1/2	4	5,896	-	-	-
TFE-3066-G [ ]	66	30	29-1/2	5	6,426	-	-	-
TFE-3072-G [ ]	72	30	29-1/2	5	6,627	-	-	-
TFE-3078-G [ ]	78	30	29-1/2	5	7,304	-	-	-
TFE-3084-G [ ]	84	30	29-1/2	7	7,521	-	-	-
TFE-3090-G [ ]	90	30	29-1/2	7	8,139	-	-	-
TFE-3096-G [ ]	96	30	29-1/2	7	8,365	-	-	-
TFE-3660-G [ ]	60	36	29-1/2	5	6,201	-	-	-
TFE-3666-G [ ]	66	36	29-1/2	5	6,780	-	-	-
TFE-3672-G [ ]	72	36	29-1/2	5	7,014	-	-	-
TFE-3678-G [ ]	78	36	29-1/2	5	7,752	-	-	-
TFE-3684-G [ ]	84	36	29-1/2	7	8,003	-	-	-
TFE-3690-G [ ]	90	36	29-1/2	7	8,683	-	-	-
TFE-3696-G [ ]	96	36	29-1/2	7	8,946	-	-	-
TFE-4260-G [ ]	60	42	29-1/2	5	7,075	-	-	-
TFE-4266-G [ ]	66	42	29-1/2	5	7,760	-	-	-
TFE-4272-G [ ]	72	42	29-1/2	5	8,049	8,049	8,426	8,850
TFE-4278-G [ ]	78	42	29-1/2	5	8,919	8,919	9,321	9,775
TFE-4284-G [ ]	84	42	29-1/2	7	9,228	9,228	9,630	10,086
TFE-4290-G [ ]	90	42	29-1/2	7	10,034	10,034	10,457	10,936
TFE-4296-G [ ]	96	42	29-1/2	7	10,360	10,360	10,783	11,262
TFE-4860-G [ ]	60	48	29-1/2	5	7,663	-	-	-
TFE-4866-G [ ]	66	48	29-1/2	5	8,426	-	-	-
TFE-4872-G [ ]	72	48	29-1/2	5	8,761	8,761	9,151	9,591
TFE-4878-G [ ]	78	48	29-1/2	7	9,730	9,730	10,147	10,616
TFE-4884-G [ ]	84	48	29-1/2	7	10,089	10,089	10,506	10,977
TFE-4890-G [ ]	90	48	29-1/2	7	10,991	10,991	11,429	11,924
TFE-4896-G [ ]	96	48	29-1/2	7	11,370	11,370	11,807	12,301

[ ] Slab Base, Specify Paint (-PS) or Veneer (-V)

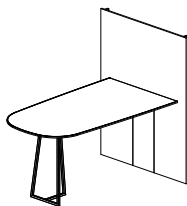

Shown with optional Monitor Panel (-MP)

### OPTIONS

	CODE	PRICE	NOTES
Power & Data Options			See pages 123-133
Remove Slab Base	Add <b>-WM</b>	Deduct \$672	Mounted directly to wall
<b>Polished Chrome Finish Options:</b>			
Polished Chrome Open Frame Base	Add <b>-PCOF-TWA</b>	\$1,230	
<b>Satin Glass Options:</b>			
Satin Glass	Add <b>-TFSG</b>	\$635	
<b>Monitor Panel Options:</b>			
42"-Wide Monitor Panel	Add <b>-MP30</b>	\$1,996	For use with 30"-Wide Tables
48"-Wide Monitor Panel	Add <b>-MP36</b>	\$2,200	For use with 36"-Wide Tables
54"-Wide Monitor Panel	Add <b>-MP42</b>	\$2,405	For use with 42"-Wide Tables
60"-Wide Monitor Panel	Add <b>-MP48</b>	\$2,612	For use with 48"-Wide Tables

### EDGE PROFILE



Two4Six Glass Edge

### GENERAL INFORMATION

- Tops are 1-1/8"-thick with 3/16"-thick hardwood edge band
- Seating capacity based on 27" per person
- Overall table height 29.5"
- Standard with quarter cut veneer
- Must be anchored to a wall, with or without Slab Base
- One section of wire management channel provided per table
- Monitor Panel will be 12" wider than the table specified
- Monitor Panel mounts directly to the wall
- Monitor Panel is 78" high
- Monitor panel available in Paint or Veneer Finish options only
- Only Woodgrain Laminate options are available for the Racetrack Base
- Racetrack Bases have a removable access door

### REQUIRED INFORMATION (ORDER CANNOT BE ENTERED WITHOUT THIS INFORMATION)

- See appendix pages vi-vii for surface material options.
- Choose Glass Finish
  - Choose Veneer Finish, if applicable
  - Choose Paint Finish if -PS Base is specified
  - Choose Metal Finish
  - Choose Sub-Top Finish: Paint Finish or Wood Species & Finish



# SOLID SURFACE TOP



D-SHAPE TOP

### BASE KEY

OF Open Frame

RCL Laminate Racetrack Base  
RCP Painted Racetrack Base  
RCV Veneer Racetrack Base

### D-SHAPE TOP // SLAB BASE // SEATED HEIGHT

MODEL #	LENGTH	WIDTH	HEIGHT	SEATING CAPACITY	-OF	-RCL	-RCP	-RCV
TFE-3060-SS [ ]	60	30	29-1/2	4	6,160	-	-	-
TFE-3066-SS [ ]	66	30	29-1/2	5	6,714	-	-	-
TFE-3072-SS [ ]	72	30	29-1/2	5	6,925	-	-	-
TFE-3078-SS [ ]	78	30	29-1/2	5	7,632	-	-	-
TFE-3084-SS [ ]	84	30	29-1/2	7	7,859	-	-	-
TFE-3090-SS [ ]	90	30	29-1/2	7	8,504	-	-	-
TFE-3096-SS [ ]	96	30	29-1/2	7	8,741	-	-	-
TFE-3660-SS [ ]	60	36	29-1/2	5	6,480	-	-	-
TFE-3666-SS [ ]	66	36	29-1/2	5	7,084	-	-	-
TFE-3672-SS [ ]	72	36	29-1/2	5	7,329	-	-	-
TFE-3678-SS [ ]	78	36	29-1/2	5	8,100	-	-	-
TFE-3684-SS [ ]	84	36	29-1/2	7	8,362	-	-	-
TFE-3690-SS [ ]	90	36	29-1/2	7	9,073	-	-	-
TFE-3696-SS [ ]	96	36	29-1/2	7	9,347	-	-	-
TFE-4260-SS [ ]	60	42	29-1/2	5	7,393	-	-	-
TFE-4266-SS [ ]	66	42	29-1/2	5	8,108	-	-	-
TFE-4272-SS [ ]	72	42	29-1/2	5	8,410	8,410	8,804	9,247
TFE-4278-SS [ ]	78	42	29-1/2	5	9,319	9,319	9,740	10,214
TFE-4284-SS [ ]	84	42	29-1/2	7	9,642	9,642	10,062	10,538
TFE-4290-SS [ ]	90	42	29-1/2	7	10,485	10,485	10,926	11,427
TFE-4296-SS [ ]	96	42	29-1/2	7	10,825	10,825	11,267	11,767
TFE-4860-SS [ ]	60	48	29-1/2	5	8,007	-	-	-
TFE-4866-SS [ ]	66	48	29-1/2	5	8,804	-	-	-
TFE-4872-SS [ ]	72	48	29-1/2	5	9,155	9,155	9,562	10,022
TFE-4878-SS [ ]	78	48	29-1/2	7	10,167	10,167	10,602	11,093
TFE-4884-SS [ ]	84	48	29-1/2	7	10,542	10,542	10,977	11,469
TFE-4890-SS [ ]	90	48	29-1/2	7	11,484	11,484	11,942	12,459
TFE-4896-SS [ ]	96	48	29-1/2	7	11,880	11,880	12,336	12,853

[ ] Slab Base, Specify Paint (-PS) or Veneer (-V)

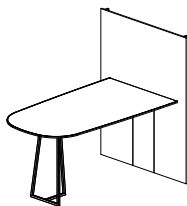

Shown with optional Monitor Panel (-MP)

### OPTIONS

Power & Data Options

See pages 123-133

Remove Slab Base

Add **-WM**

Deduct \$672

Mounted directly to wall

### Polished Chrome Finish Options:

Polished Chrome Open Frame Base

Add **-PCOF-TWA**

\$1,230

### Monitor Panel Options:

42"-Wide Monitor Panel

Add **-MP30**

\$1,996

For use with 30"-Wide Tables

48"-Wide Monitor Panel

Add **-MP36**

\$2,200

For use with 36"-Wide Tables

54"-Wide Monitor Panel

Add **-MP42**

\$2,405

For use with 42"-Wide Tables

60"-Wide Monitor Panel

Add **-MP48**

\$2,612

For use with 48"-Wide Tables

### EDGE PROFILE

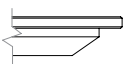

Two4Six Solid Surface Edge

### GENERAL INFORMATION

- Seating capacity based on 27" per person
- Overall table height 29.5"
- Standard with quarter cut veneer
- Must be anchored to a wall, with or without Slab Base
- One section of wire management channel provided per table
- Monitor Panel will be 12" wider than the table specified

- Monitor Panel mounts directly to the wall
- Monitor Panel is 78" high
- Monitor panel available in Paint or Veneer Finish options only
- Only Woodgrain Laminate options are available for the Racetrack Base
- Racetrack Bases have a removable access door

### REQUIRED INFORMATION (ORDER CANNOT BE ENTERED WITHOUT THIS INFORMATION)

See appendix pages vi-vii for surface material options.

- Choose Solid Surface Finish
- Choose Veneer Finish, if applicable
- Choose Paint Finish if -PS Base is specified
- Choose Metal Finish



# VENEER TOP WITH HARDWOOD EDGE



D-SHAPE TOP

**BASE KEY**

OF Open Frame

**D-SHAPE TOP // SLAB BASE // COUNTER HEIGHT**

MODEL #	LENGTH	WIDTH	HEIGHT	SEATING CAPACITY	-OF
TFH-3060-V [ ]	60	30	36	5	3,880
TFH-3660-V [ ]	60	36	36	5	4,076
TFH-4260-V [ ]	60	42	36	5	4,645
TFH-4860-V [ ]	60	48	36	5	5,026
TFH-3066-V [ ]	66	30	36	5	4,226
TFH-3666-V [ ]	66	36	36	5	4,453
TFH-4266-V [ ]	66	42	36	5	5,090
TFH-4866-V [ ]	66	48	36	5	5,521
TFH-3072-V [ ]	72	30	36	5	4,355
TFH-3672-V [ ]	72	36	36	5	4,603
TFH-4272-V [ ]	72	42	36	5	5,275
TFH-4872-V [ ]	72	48	36	5	5,736
TFH-3078-V [ ]	78	30	36	5	4,796
TFH-3678-V [ ]	78	36	36	5	5,083
TFH-4278-V [ ]	78	42	36	5	5,841
TFH-4878-V [ ]	78	48	36	5	6,365
TFH-3084-V [ ]	84	30	36	7	4,935
TFH-3684-V [ ]	84	36	36	7	5,244
TFH-4284-V [ ]	84	42	36	7	6,039
TFH-4884-V [ ]	84	48	36	7	6,596
TFH-3090-V [ ]	90	30	36	7	5,337
TFH-3690-V [ ]	90	36	36	7	5,686
TFH-4290-V [ ]	90	42	36	7	6,562
TFH-4890-V [ ]	90	48	36	7	7,180
TFH-3096-V [ ]	96	30	36	7	5,482
TFH-3696-V [ ]	96	36	36	7	5,854
TFH-4296-V [ ]	96	42	36	7	6,771
TFH-4896-V [ ]	96	48	36	7	7,422

[ ] Slab Base, Specify Paint (-PS) or Veneer (-V)

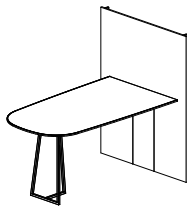

Shown with optional Monitor Panel (-MP)

**OPTIONS**

Power & Data Options

See pages 123-133

Remove Slab Base

Add **-WM**

Deduct \$672

Mounted directly to wall

**Polished Chrome Finish Options:**

Polished Chrome Open Frame Base

Add **-PCOF-TWC**

\$1,407

**Monitor Panel Options:**

42"-Wide Monitor Panel

Add **-MP30**

\$1,996

For use with 30"-Wide Tables

48"-Wide Monitor Panel

Add **-MP36**

\$2,200

For use with 36"-Wide Tables

54"-Wide Monitor Panel

Add **-MP42**

\$2,405

For use with 42"-Wide Tables

60"-Wide Monitor Panel

Add **-MP48**

\$2,612

For use with 48"-Wide Tables

**EDGE PROFILE**

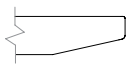

Two4Six Cutback Edge

**GENERAL INFORMATION**

- Tops are 1-1/8"-thick with 3/16"-thick hardwood edge band
- Seating capacity based on 27" per person
- Overall table height 36"
- Standard with quarter cut veneer
- Must be anchored to a wall, with or without Slab Base

- One section of wire management channel provided per table
- Monitor Panel will be 12" wider than the table specified
- Monitor Panel mounts directly to the wall
- Monitor Panel is 78" high

**REQUIRED INFORMATION (ORDER CANNOT BE ENTERED WITHOUT THIS INFORMATION)**

See appendix pages vi-vii for surface material options.

- Choose Veneer Finish. If -V option is specified for the Slab Base, the finish will be the same as the table top.
- Choose Paint Finish, if -PS Slab Base is specified
- Choose Metal Finish



# INSET LAMINATE TOP WITH HARDWOOD EDGE



D-SHAPE TOP

**BASE KEY**

OF Open Frame

**D-SHAPE TOP // SLAB BASE // COUNTER HEIGHT**

MODEL #	LENGTH	WIDTH	HEIGHT	SEATING CAPACITY	-OF
TFH-3060-P [ ]	60	30	36	5	3,667
TFH-3660-P [ ]	60	36	36	5	3,852
TFH-4260-P [ ]	60	42	36	5	4,390
TFH-4860-P [ ]	60	48	36	5	4,750
TFH-3066-P [ ]	66	30	36	5	3,994
TFH-3666-P [ ]	66	36	36	5	4,209
TFH-4266-P [ ]	66	42	36	5	4,811
TFH-4866-P [ ]	66	48	36	5	5,218
TFH-3072-P [ ]	72	30	36	5	4,116
TFH-3672-P [ ]	72	36	36	5	4,350
TFH-4272-P [ ]	72	42	36	5	4,985
TFH-4872-P [ ]	72	48	36	5	5,421
TFH-3078-P [ ]	78	30	36	5	4,533
TFH-3678-P [ ]	78	36	36	5	4,804
TFH-4278-P [ ]	78	42	36	5	5,520
TFH-4878-P [ ]	78	48	36	5	6,015
TFH-3084-P [ ]	84	30	36	7	4,664
TFH-3684-P [ ]	84	36	36	7	4,956
TFH-4284-P [ ]	84	42	36	7	5,707
TFH-4884-P [ ]	84	48	36	7	6,234
TFH-3090-P [ ]	90	30	36	7	5,044
TFH-3690-P [ ]	90	36	36	7	5,374
TFH-4290-P [ ]	90	42	36	7	6,202
TFH-4890-P [ ]	90	48	36	7	6,786
TFH-3096-P [ ]	96	30	36	7	5,181
TFH-3696-P [ ]	96	36	36	7	5,533
TFH-4296-P [ ]	96	42	36	7	6,399
TFH-4896-P [ ]	96	48	36	7	7,014

[ ] Slab Base, Specify Paint (-PS) or Veneer (-V)

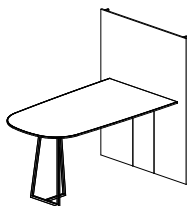

Shown with optional Monitor Panel (-MP)

**OPTIONS**

Power & Data Options

**CODE**

**PRICE**

**NOTES**

Remove Slab Base

Add **-WM**

Deduct \$672

See pages 123-133

Mounted directly to wall

**Polished Chrome Finish Options:**

Polished Chrome Open Frame Base

Add **-PCOF-TWC**

\$1,407

**Monitor Panel Options:**

42"-Wide Monitor Panel

Add **-MP30**

\$1,996

For use with 30"-Wide Tables

48"-Wide Monitor Panel

Add **-MP36**

\$2,200

For use with 36"-Wide Tables

54"-Wide Monitor Panel

Add **-MP42**

\$2,405

For use with 42"-Wide Tables

60"-Wide Monitor Panel

Add **-MP48**

\$2,612

For use with 48"-Wide Tables

**EDGE PROFILE**

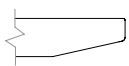

Two4Six Cutback Edge

**GENERAL INFORMATION**

- Tops are 1-1/8"-thick with 3/16"-thick hardwood edge band
- Seating capacity based on 27" per person
- Overall table height 36"
- Standard with quarter cut veneer
- Must be anchored to a wall, with or without Slab Base
- One section of wire management channel provided per table

- Monitor Panel will be 12" wider than the table specified
- Monitor Panel mounts directly to the wall
- Monitor Panel is 78" high
- Monitor panel available in Paint or Veneer Finish options only

**REQUIRED INFORMATION (ORDER CANNOT BE ENTERED WITHOUT THIS INFORMATION)**

See appendix pages vi-vii for surface material options.

- Choose Laminate Finish
- Choose Wood Species & Finish for Hardwood Edge
- Choose Metal Finish
- Choose Paint Finish, if -PS Slab Base is specified
- Choose Veneer Finish, if -V Slab Base is specified



# LAMINATE TOP WITH ABS CUTBACK EDGE



D-SHAPE TOP

**BASE KEY**

OF Open Frame

**D-SHAPE TOP // SLAB BASE // COUNTER HEIGHT**

MODEL #	LENGTH	WIDTH	HEIGHT	SEATING CAPACITY	-OF
TFH-3060-PA [ ]	60	30	36	5	3,667
TFH-3660-PA [ ]	60	36	36	5	3,852
TFH-4260-PA [ ]	60	42	36	5	4,390
TFH-4860-PA [ ]	60	48	36	5	4,750
TFH-3066-PA [ ]	66	30	36	5	3,994
TFH-3666-PA [ ]	66	36	36	5	4,209
TFH-4266-PA [ ]	66	42	36	5	4,811
TFH-4866-PA [ ]	66	48	36	5	5,218
TFH-3072-PA [ ]	72	30	36	5	4,116
TFH-3672-PA [ ]	72	36	36	5	4,350
TFH-4272-PA [ ]	72	42	36	5	4,985
TFH-4872-PA [ ]	72	48	36	5	5,421
TFH-3078-PA [ ]	78	30	36	5	4,533
TFH-3678-PA [ ]	78	36	36	5	4,804
TFH-4278-PA [ ]	78	42	36	5	5,520
TFH-4878-PA [ ]	78	48	36	5	6,015
TFH-3084-PA [ ]	84	30	36	7	4,664
TFH-3684-PA [ ]	84	36	36	7	4,956
TFH-4284-PA [ ]	84	42	36	7	5,707
TFH-4884-PA [ ]	84	48	36	7	6,234
TFH-3090-PA [ ]	90	30	36	7	5,044
TFH-3690-PA [ ]	90	36	36	7	5,374
TFH-4290-PA [ ]	90	42	36	7	6,202
TFH-4890-PA [ ]	90	48	36	7	6,786
TFH-3096-PA [ ]	96	30	36	7	5,181
TFH-3696-PA [ ]	96	36	36	7	5,533
TFH-4296-PA [ ]	96	42	36	7	6,399
TFH-4896-PA [ ]	96	48	36	7	7,014

[ ] Slab Base, Specify Paint (-PS) or Veneer (-V)

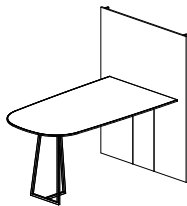

Shown with optional Monitor Panel (-MP)

OPTIONS	CODE	PRICE	NOTES
Power & Data Options			See pages 123-133
Remove Slab Base	Add <b>-WM</b>	Deduct \$672	Mounted directly to wall
<b>Polished Chrome Finish Options:</b>			
Polished Chrome Open Frame Base	Add <b>-PCOF-TWC</b>	\$1,407	
<b>Monitor Panel Options:</b>			
42"-Wide Monitor Panel	Add <b>-MP30</b>	\$1,996	For use with 30"-Wide Tables
48"-Wide Monitor Panel	Add <b>-MP36</b>	\$2,200	For use with 36"-Wide Tables
54"-Wide Monitor Panel	Add <b>-MP42</b>	\$2,405	For use with 42"-Wide Tables
60"-Wide Monitor Panel	Add <b>-MP48</b>	\$2,612	For use with 48"-Wide Tables

**EDGE PROFILE**

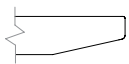

Two4Six Cutback Edge

**GENERAL INFORMATION**

- Tops are 1-1/8"-thick
- Seating capacity based on 27" per person
- Overall table height 36"
- Standard with quarter cut veneer
- Must be anchored to a wall, with or without Slab Base
- One section of wire management channel provided per table
- Monitor Panel will be 12" wider than the table specified
- Monitor Panel mounts directly to the wall
- Monitor Panel is 78" high
- Monitor panel available in Paint or Veneer Finish options only

**REQUIRED INFORMATION (ORDER CANNOT BE ENTERED WITHOUT THIS INFORMATION)**

See appendix pages vi-vii for surface material options.

- Choose Laminate Finish
- Choose ABS Edge Finish
- Choose Metal Finish
- Choose Paint Finish, if -PS Slab Base is specified
- Choose Veneer Finish, if -V Slab Base is specified



## LAMINATE TOP WITH ABS SQUARE EDGE



D-SHAPE TOP

## BASE KEY

OF Open Frame

## D-SHAPE TOP // SLAB BASE // COUNTER HEIGHT

MODEL #	LENGTH	WIDTH	HEIGHT	SEATING CAPACITY	-OF
TFH-3060-PE [ ]	60	30	36	5	3,485
TFH-3660-PE [ ]	60	36	36	5	3,661
TFH-4260-PE [ ]	60	42	36	5	4,172
TFH-4860-PE [ ]	60	48	36	5	4,514
TFH-3066-PE [ ]	66	30	36	5	3,795
TFH-3666-PE [ ]	66	36	36	5	3,999
TFH-4266-PE [ ]	66	42	36	5	4,571
TFH-4866-PE [ ]	66	48	36	5	4,958
TFH-3072-PE [ ]	72	30	36	5	3,911
TFH-3672-PE [ ]	72	36	36	5	4,134
TFH-4272-PE [ ]	72	42	36	5	4,737
TFH-4872-PE [ ]	72	48	36	5	5,151
TFH-3078-PE [ ]	78	30	36	5	4,307
TFH-3678-PE [ ]	78	36	36	5	4,565
TFH-4278-PE [ ]	78	42	36	5	5,246
TFH-4878-PE [ ]	78	48	36	5	5,716
TFH-3084-PE [ ]	84	30	36	7	4,432
TFH-3684-PE [ ]	84	36	36	7	4,710
TFH-4284-PE [ ]	84	42	36	7	5,424
TFH-4884-PE [ ]	84	48	36	7	5,924
TFH-3090-PE [ ]	90	30	36	7	4,793
TFH-3690-PE [ ]	90	36	36	7	5,107
TFH-4290-PE [ ]	90	42	36	7	5,893
TFH-4890-PE [ ]	90	48	36	7	6,448
TFH-3096-PE [ ]	96	30	36	7	4,923
TFH-3696-PE [ ]	96	36	36	7	5,257
TFH-4296-PE [ ]	96	42	36	7	6,081
TFH-4896-PE [ ]	96	48	36	7	6,665

[ ] Slab Base, Specify Paint (-PS) or Veneer (-V)

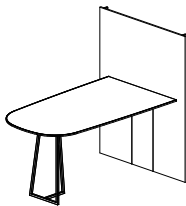

Shown with optional Monitor Panel (-MP)

## OPTIONS

Power &amp; Data Options

## CODE

## PRICE

## NOTES

See pages 123-133

Remove Slab Base

Add -WM

Deduct \$672

Mounted directly to wall

## Polished Chrome Finish Options:

Polished Chrome Open Frame Base

Add -PCOF-TWC

\$1,407

## Monitor Panel Options:

42"-Wide Monitor Panel

Add -MP30

\$1,996

For use with 30"-Wide Tables

48"-Wide Monitor Panel

Add -MP36

\$2,200

For use with 36"-Wide Tables

54"-Wide Monitor Panel

Add -MP42

\$2,405

For use with 42"-Wide Tables

60"-Wide Monitor Panel

Add -MP48

\$2,612

For use with 48"-Wide Tables

## EDGE PROFILE



Two4Six Square Edge

## GENERAL INFORMATION

- Tops are 1-1/8"-thick
- Seating capacity based on 27" per person
- Overall table height 36"
- Standard with quarter cut veneer
- Must be anchored to a wall, with or without Slab Base
- One section of wire management channel provided per table

- Monitor Panel will be 12" wider than the table specified
- Monitor Panel mounts directly to the wall
- Monitor Panel is 78" high
- Monitor panel available in Paint or Veneer Finish options only

## REQUIRED INFORMATION (ORDER CANNOT BE ENTERED WITHOUT THIS INFORMATION)

See appendix pages vi-vii for surface material options.

- Choose Laminate Finish
- Choose ABS Edge Finish
- Choose Metal Finish
- Choose Paint Finish, if -PS Slab Base is specified
- Choose Veneer Finish, if -V Slab Base is specified



# GLASS TOP



D-SHAPE TOP

**BASE KEY**

OF Open Frame

**D-SHAPE TOP // SLAB BASE // COUNTER HEIGHT**

MODEL #	LENGTH	WIDTH	HEIGHT	SEATING CAPACITY	-OF
TFH-3060-G [ ]	60	30	36	5	6,053
TFH-3660-G [ ]	60	36	36	5	6,359
TFH-4260-G [ ]	60	42	36	5	7,247
TFH-4860-G [ ]	60	48	36	5	7,841
TFH-3066-G [ ]	66	30	36	5	6,593
TFH-3666-G [ ]	66	36	36	5	6,947
TFH-4266-G [ ]	66	42	36	5	7,941
TFH-4866-G [ ]	66	48	36	5	8,613
TFH-3072-G [ ]	72	30	36	5	6,794
TFH-3672-G [ ]	72	36	36	5	7,181
TFH-4272-G [ ]	72	42	36	5	8,229
TFH-4872-G [ ]	72	48	36	5	8,949
TFH-3078-G [ ]	78	30	36	5	7,482
TFH-3678-G [ ]	78	36	36	5	7,930
TFH-4278-G [ ]	78	42	36	5	9,112
TFH-4878-G [ ]	78	48	36	5	9,930
TFH-3084-G [ ]	84	30	36	7	7,699
TFH-3684-G [ ]	84	36	36	7	8,181
TFH-4284-G [ ]	84	42	36	7	9,421
TFH-4884-G [ ]	84	48	36	7	10,290
TFH-3090-G [ ]	90	30	36	7	8,326
TFH-3690-G [ ]	90	36	36	7	8,871
TFH-4290-G [ ]	90	42	36	7	10,237
TFH-4890-G [ ]	90	48	36	7	11,201
TFH-3096-G [ ]	96	30	36	7	8,552
TFH-3696-G [ ]	96	36	36	7	9,133
TFH-4296-G [ ]	96	42	36	7	10,563
TFH-4896-G [ ]	96	48	36	7	11,579

[ ] Slab Base, Specify Paint (-PS) or Veneer (-V)

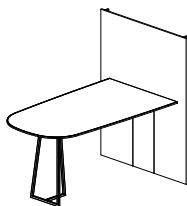

Shown with optional Monitor Panel (-MP)

OPTIONS	CODE	PRICE	NOTES
Power & Data Options			See pages 123-133
Remove Slab Base	Add <b>-WM</b>	Deduct \$672	Mounted directly to wall
<b>Polished Chrome Finish Options:</b>			
Polished Chrome Open Frame Base	Add <b>-PCOF-TWC</b>	\$1,407	
<b>Satin Glass Options:</b>			
Satin Glass	Add <b>-TFSG</b>	\$635	
<b>Monitor Panel Options:</b>			
42"-Wide Monitor Panel	Add <b>-MP30</b>	\$1,996	For use with 30"-Wide Tables
48"-Wide Monitor Panel	Add <b>-MP36</b>	\$2,200	For use with 36"-Wide Tables
54"-Wide Monitor Panel	Add <b>-MP42</b>	\$2,405	For use with 42"-Wide Tables
60"-Wide Monitor Panel	Add <b>-MP48</b>	\$2,612	For use with 48"-Wide Tables

**EDGE PROFILE**



Two4Six Glass Edge

**GENERAL INFORMATION**

- Tops are 1-1/8"-thick with 3/16"-thick hardwood edge band
- Seating capacity based on 27" per person
- Overall table height 36"
- Standard with quarter cut veneer
- Must be anchored to a wall, with or without Slab Base
- One section of wire management channel provided per table
- Monitor Panel will be 12" wider than the table specified
- Monitor Panel mounts directly to the wall
- Monitor Panel is 78" high
- Monitor panel available in Paint or Veneer Finish options only

**REQUIRED INFORMATION (ORDER CANNOT BE ENTERED WITHOUT THIS INFORMATION)**

- See appendix pages vi-vii for surface material options.
- Choose Glass Finish
  - Choose Metal Finish
  - Choose Paint Finish, if -PS Slab Base is specified
  - Choose Veneer Finish, if -V Slab Base is specified
  - Choose Sub-Top Finish: Paint Finish or Wood Species & Finish





# SOLID SURFACE TOP



D-SHAPE TOP

**BASE KEY**

OF Open Frame

**D-SHAPE TOP // SLAB BASE // COUNTER HEIGHT**

MODEL #	LENGTH	WIDTH	HEIGHT	SEATING CAPACITY	-OF
TFH-3060-SS [ ]	60	30	36	5	6,325
TFH-3660-SS [ ]	60	36	36	5	6,644
TFH-4260-SS [ ]	60	42	36	5	7,572
TFH-4860-SS [ ]	60	48	36	5	8,193
TFH-3066-SS [ ]	66	30	36	5	6,889
TFH-3666-SS [ ]	66	36	36	5	7,259
TFH-4266-SS [ ]	66	42	36	5	8,297
TFH-4866-SS [ ]	66	48	36	5	9,000
TFH-3072-SS [ ]	72	30	36	5	7,099
TFH-3672-SS [ ]	72	36	36	5	7,503
TFH-4272-SS [ ]	72	42	36	5	8,599
TFH-4872-SS [ ]	72	48	36	5	9,350
TFH-3078-SS [ ]	78	30	36	5	7,818
TFH-3678-SS [ ]	78	36	36	5	8,286
TFH-4278-SS [ ]	78	42	36	5	9,521
TFH-4878-SS [ ]	78	48	36	5	10,375
TFH-3084-SS [ ]	84	30	36	7	8,045
TFH-3684-SS [ ]	84	36	36	7	8,548
TFH-4284-SS [ ]	84	42	36	7	9,844
TFH-4884-SS [ ]	84	48	36	7	10,752
TFH-3090-SS [ ]	90	30	36	7	8,700
TFH-3690-SS [ ]	90	36	36	7	9,269
TFH-4290-SS [ ]	90	42	36	7	10,697
TFH-4890-SS [ ]	90	48	36	7	11,704
TFH-3096-SS [ ]	96	30	36	7	8,936
TFH-3696-SS [ ]	96	36	36	7	9,543
TFH-4296-SS [ ]	96	42	36	7	11,037
TFH-4896-SS [ ]	96	48	36	7	12,098

[ ] Slab Base, Specify Paint (-PS) or Veneer (-V)

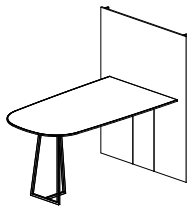

Shown with optional Monitor Panel (-MP)

OPTIONS	CODE	PRICE	NOTES
Power & Data Options			See pages 123-133
Remove Slab Base	Add <b>-WM</b>	Deduct \$672	Mounted directly to wall
<b>Polished Chrome Finish Options:</b>			
Polished Chrome Open Frame Base	Add <b>-PCOF-TWC</b>	\$1,407	
<b>Monitor Panel Options:</b>			
42"-Wide Monitor Panel	Add <b>-MP30</b>	\$1,996	For use with 30"-Wide Tables
48"-Wide Monitor Panel	Add <b>-MP36</b>	\$2,200	For use with 36"-Wide Tables
54"-Wide Monitor Panel	Add <b>-MP42</b>	\$2,405	For use with 42"-Wide Tables
60"-Wide Monitor Panel	Add <b>-MP48</b>	\$2,612	For use with 48"-Wide Tables

**EDGE PROFILE**



Two4Six Solid Surface Edge

**GENERAL INFORMATION**

- Seating capacity based on 27" per person
- Overall table height 36"
- Standard with quarter cut veneer
- Must be anchored to a wall, with or without Slab Base
- One section of wire management channel provided per table
- Monitor Panel will be 12" wider than the table specified
- Monitor Panel mounts directly to the wall
- Monitor Panel is 78" high
- Monitor panel available in Paint or Veneer Finish options only

**REQUIRED INFORMATION (ORDER CANNOT BE ENTERED WITHOUT THIS INFORMATION)**

See appendix pages vi-vii for surface material options.

- Choose Solid Surface Finish
- Choose Metal Finish
- Choose Paint Finish, if -PS Slab Base is specified
- Choose Veneer Finish, if -V Slab Base is specified



# VENEER TOP WITH HARDWOOD EDGE



D-SHAPE TOP

**BASE KEY**

OF Open Frame

RCL Laminate Racetrack Base  
 RCP Painted Racetrack Base  
 RCV Veneer Racetrack Base

**D-SHAPE TOP // SLAB BASE // STANDING HEIGHT**

MODEL #	LENGTH	WIDTH	HEIGHT	SEATING CAPACITY	-OF	-RCL	-RCP	-RCV [ ]
TFN-3060-V [ ]	60	30	42	5	3,978	-	-	-
TFN-3066-V [ ]	66	30	42	5	4,329	-	-	-
TFN-3072-V [ ]	72	30	42	5	4,459	-	-	-
TFN-3078-V [ ]	78	30	42	5	4,907	-	-	-
TFN-3084-V [ ]	84	30	42	7	5,046	-	-	-
TFN-3090-V [ ]	90	30	42	7	5,453	-	-	-
TFN-3096-V [ ]	96	30	42	7	5,599	-	-	-
TFN-3660-V [ ]	60	36	42	5	4,174	-	-	-
TFN-3666-V [ ]	66	36	42	5	4,556	-	-	-
TFN-3672-V [ ]	72	36	42	5	4,707	-	-	-
TFN-3678-V [ ]	78	36	42	5	5,194	-	-	-
TFN-3684-V [ ]	84	36	42	7	5,355	-	-	-
TFN-3690-V [ ]	90	36	42	7	5,802	-	-	-
TFN-3696-V [ ]	96	36	42	7	5,971	-	-	-
TFN-4260-V [ ]	60	42	42	5	4,752	-	-	-
TFN-4266-V [ ]	66	42	42	5	5,203	-	-	-
TFN-4272-V [ ]	72	42	42	5	5,388	5,388	5,795	6,146
TFN-4278-V [ ]	78	42	42	5	5,961	5,961	6,397	6,772
TFN-4284-V [ ]	84	42	42	7	6,160	6,160	6,595	6,970
TFN-4290-V [ ]	90	42	42	7	6,689	6,689	7,147	7,542
TFN-4296-V [ ]	96	42	42	7	6,898	6,898	7,356	7,751
TFN-4860-V [ ]	60	48	42	5	5,136	-	-	-
TFN-4866-V [ ]	66	48	42	5	5,637	-	-	-
TFN-4872-V [ ]	72	48	42	5	5,853	5,853	6,274	6,637
TFN-4878-V [ ]	78	48	42	5	6,490	6,490	6,940	7,328
TFN-4884-V [ ]	84	48	42	7	6,720	6,720	7,171	7,559
TFN-4890-V [ ]	90	48	42	7	7,311	7,311	7,785	8,194
TFN-4896-V [ ]	96	48	42	7	7,554	7,554	8,028	8,436

[ ] Slab Base, Specify Paint (-PS) or Veneer (-V)

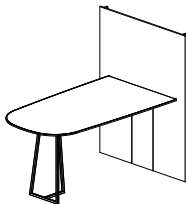

Shown with optional Monitor Panel (-MP)

OPTIONS	CODE	PRICE	NOTES
Power & Data Options			See pages 123-133
Remove Slab Base	Add <b>-WM</b>	Deduct \$672	Mounted directly to wall
<b>Polished Chrome Finish Options:</b>			
Polished Chrome Open Frame Base	Add <b>-PCOF-TWD</b>	\$1,590	
<b>Monitor Panel Options:</b>			
42"-Wide Monitor Panel	Add <b>-MP30</b>	\$1,996	For use with 30"-Wide Tables
48"-Wide Monitor Panel	Add <b>-MP36</b>	\$2,200	For use with 36"-Wide Tables
54"-Wide Monitor Panel	Add <b>-MP42</b>	\$2,405	For use with 42"-Wide Tables
60"-Wide Monitor Panel	Add <b>-MP48</b>	\$2,612	For use with 48"-Wide Tables

**EDGE PROFILE**

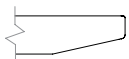

Two4Six Cutback Edge

**GENERAL INFORMATION**

- Tops are 1-1/8"-thick with 3/16"-thick hardwood edge band
- Seating capacity based on 27" per person
- Overall table height 42"
- Standard with quarter cut veneer
- Must be anchored to a wall, with or without Slab Base
- One section of wire management channel provided per table
- Monitor Panel will be 12" wider than the table specified
- Monitor Panel mounts directly to the wall
- Monitor Panel is 78" high
- Not available with Power Matrix
- Only Woodgrain Laminate options are available for the Racetrack Base
- Racetrack Bases have a removable access door

**REQUIRED INFORMATION (ORDER CANNOT BE ENTERED WITHOUT THIS INFORMATION)**

See appendix pages vi-vii for surface material options.

- Choose Veneer Finish. If -V option is specified for the Slab Base, the finish will be the same as the table top.
- Choose Paint Finish, if -PS Slab Base is specified
- Choose Metal Finish



# INSET LAMINATE TOP WITH HARDWOOD EDGE



D-SHAPE TOP

**BASE KEY**

OF Open Frame

RCL Laminate Racetrack Base  
 RCP Painted Racetrack Base  
 RCV Veneer Racetrack Base

**D-SHAP [ ] E TOP [ ] // SLAB BASE // STANDING HEIGHT**

MODEL #	LENGTH	WIDTH	HEIGHT	SEATING CAP [ ] ACITY	-OF	-RCL	-RCP [ ]	-RCV
TFN-3060-P [ ]	60	30	42	5	3,760	-	-	-
TFN-3066-P [ ]	66	30	42	5	4,091	-	-	-
TFN-3072-P [ ]	72	30	42	5	4,214	-	-	-
TFN-3078-P [ ]	78	30	42	5	4,638	-	-	-
TFN-3084-P [ ]	84	30	42	7	4,769	-	-	-
TFN-3090-P [ ]	90	30	42	7	5,154	-	-	-
TFN-3096-P [ ]	96	30	42	7	5,292	-	-	-
TFN-3660-P [ ]	60	36	42	5	3,945	-	-	-
TFN-3666-P [ ]	66	36	42	5	4,306	-	-	-
TFN-3672-P [ ]	72	36	42	5	4,449	-	-	-
TFN-3678-P [ ]	78	36	42	5	4,909	-	-	-
TFN-3684-P [ ]	84	36	42	7	5,061	-	-	-
TFN-3690-P [ ]	90	36	42	7	5,483	-	-	-
TFN-3696-P [ ]	96	36	42	7	5,643	-	-	-
TFN-4260-P [ ]	60	42	42	5	4,491	-	-	-
TFN-4266-P [ ]	66	42	42	5	4,917	-	-	-
TFN-4272-P [ ]	72	42	42	5	5,092	5,092	5,477	5,808
TFN-4278-P [ ]	78	42	42	5	5,634	5,634	6,046	6,400
TFN-4284-P [ ]	84	42	42	7	5,822	5,822	6,233	6,587
TFN-4290-P [ ]	90	42	42	7	6,322	6,322	6,754	7,128
TFN-4296-P [ ]	96	42	42	7	6,519	6,519	6,952	7,325
TFN-4860-P [ ]	60	48	42	5	4,854	-	-	-
TFN-4866-P [ ]	66	48	42	5	5,327	-	-	-
TFN-4872-P [ ]	72	48	42	5	5,532	5,532	5,929	6,272
TFN-4878-P [ ]	78	48	42	5	6,134	6,134	6,559	6,925
TFN-4884-P [ ]	84	48	42	7	6,351	6,351	6,777	7,144
TFN-4890-P [ ]	90	48	42	7	6,909	6,909	7,357	7,744
TFN-4896-P [ ]	96	48	42	7	7,139	7,139	7,587	7,973

[ ] Slab Base, Specify Paint (-PS) or Veneer (-V)

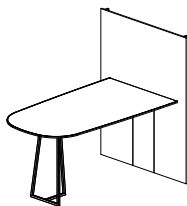

Shown with optional Monitor Panel (-MP)

**OPTIONS**

Power & Data Options

**CODE**

**PRICE**

**NOTES**

Remove Slab Base

Add **-WM**

Deduct \$672

Mounted directly to wall

**Polished Chrome Finish Options:**

Polished Chrome Open Frame Base

Add **-PCOF-TWD**

\$1,590

**Monitor Panel Options:**

42"-Wide Monitor Panel

Add **-MP30**

\$1,996

For use with 30"-Wide Tables

48"-Wide Monitor Panel

Add **-MP36**

\$2,200

For use with 36"-Wide Tables

54"-Wide Monitor Panel

Add **-MP42**

\$2,405

For use with 42"-Wide Tables

60"-Wide Monitor Panel

Add **-MP48**

\$2,612

For use with 48"-Wide Tables

**EDGE PROFILE**

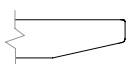

Two4Six Cutback Edge

**GENERAL INFORMATION**

- Tops are 1-1/8"-thick with 3/16"-thick hardwood edge band
- Seating capacity based on 27" per person
- Overall table height 42"
- Standard with quarter cut veneer
- Must be anchored to a wall, with or without Slab Base
- One section of wire management channel provided per table
- Monitor Panel will be 12" wider than the table specified

- Monitor Panel mounts directly to the wall
- Monitor Panel is 78" high
- Monitor panel available in Paint or Veneer Finish options only
- Not available with Power Matrix
- Only Woodgrain Laminate options are available for the Racetrack Base
- Racetrack Bases have a removable access door

**REQUIRED INFORMATION (ORDER CANNOT BE ENTERED WITHOUT THIS INFORMATION)**

See appendix pages vi-vii for surface material options.

- Choose Laminate Finish
- Choose Wood Species & Finish for Hardwood Edge
- Choose Metal Finish
- Choose Paint Finish, if -PS Slab Base is specified
- Choose Veneer Finish, if -V Slab Base is specified



# LAMINATE TOP WITH ABS CUTBACK EDGE



D-SHAPE TOP

### BASE KEY

OF Open Frame

RCL Laminate Racetrack Base  
RCP Painted Racetrack Base  
RCV Veneer Racetrack Base

## D-SHAPE TOP // SLAB BASE // STANDING HEIGHT

MODEL #	LENGTH	WIDTH	HEIGHT	SEATING CAPACITY	-OF	-RCL	-RCP	-RCV
TFN-3060-PA [ ]	60	30	42	5	3,760	-	-	-
TFN-3066-PA [ ]	66	30	42	5	4,091	-	-	-
TFN-3072-PA [ ]	72	30	42	5	4,214	-	-	-
TFN-3078-PA [ ]	78	30	42	5	4,638	-	-	-
TFN-3084-PA [ ]	84	30	42	7	4,769	-	-	-
TFN-3090-PA [ ]	90	30	42	7	5,154	-	-	-
TFN-3096-PA [ ]	96	30	42	7	5,292	-	-	-
TFN-3660-PA [ ]	60	36	42	5	3,945	-	-	-
TFN-3666-PA [ ]	66	36	42	5	4,306	-	-	-
TFN-3672-PA [ ]	72	36	42	5	4,449	-	-	-
TFN-3678-PA [ ]	78	36	42	5	4,909	-	-	-
TFN-3684-PA [ ]	84	36	42	7	5,061	-	-	-
TFN-3690-PA [ ]	90	36	42	7	5,483	-	-	-
TFN-3696-PA [ ]	96	36	42	7	5,643	-	-	-
TFN-4260-PA [ ]	60	42	42	5	4,491	-	-	-
TFN-4266-PA [ ]	66	42	42	5	4,917	-	-	-
TFN-4272-PA [ ]	72	42	42	5	5,092	5,092	5,477	5,808
TFN-4278-PA [ ]	78	42	42	5	5,634	5,634	6,046	6,400
TFN-4284-PA [ ]	84	42	42	7	5,822	5,822	6,233	6,587
TFN-4290-PA [ ]	90	42	42	7	6,322	6,322	6,754	7,128
TFN-4296-PA [ ]	96	42	42	7	6,519	6,519	6,952	7,325
TFN-4860-PA [ ]	60	48	42	5	4,854	-	-	-
TFN-4866-PA [ ]	66	48	42	5	5,327	-	-	-
TFN-4872-PA [ ]	72	48	42	5	5,532	5,532	5,929	6,272
TFN-4878-PA [ ]	78	48	42	5	6,134	6,134	6,559	6,925
TFN-4884-PA [ ]	84	48	42	7	6,351	6,351	6,777	7,144
TFN-4890-PA [ ]	90	48	42	7	6,909	6,909	7,357	7,744
TFN-4896-PA [ ]	96	48	42	7	7,139	7,139	7,587	7,973

[ ] Slab Base, Specify Paint (-PS) or Veneer (-V)

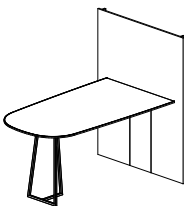

Shown with optional Monitor Panel (-MP)

### OPTIONS

Power & Data Options

See pages 123-133

Remove Slab Base

Add **-WM**

Deduct \$672

Mounted directly to wall

### Polished Chrome Finish Options:

Polished Chrome Open Frame Base

Add **-PCOF-TWD**

\$1,590

### Monitor Panel Options:

42"-Wide Monitor Panel

Add **-MP30**

\$1,996

For use with 30"-Wide Tables

48"-Wide Monitor Panel

Add **-MP36**

\$2,200

For use with 36"-Wide Tables

54"-Wide Monitor Panel

Add **-MP42**

\$2,405

For use with 42"-Wide Tables

60"-Wide Monitor Panel

Add **-MP48**

\$2,612

For use with 48"-Wide Tables

### EDGE PROFILE

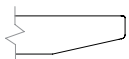

Two4Six Cutback Edge

### GENERAL INFORMATION

- Tops are 1-1/8"-thick
- Seating capacity based on 27" per person
- Overall table height 42"
- Standard with quarter cut veneer
- Must be anchored to a wall, with or without Slab Base
- One section of wire management channel provided per table
- Monitor Panel will be 12" wider than the table specified
- Monitor Panel mounts directly to the wall
- Monitor Panel is 78" high
- Monitor panel available in Paint or Veneer Finish options only
- Not available with Power Matrix
- Only Woodgrain Laminate options are available for the Racetrack Base
- Racetrack Bases have a removable access door

### REQUIRED INFORMATION (ORDER CANNOT BE ENTERED WITHOUT THIS INFORMATION)

See appendix pages vi-vii for surface material options.

- Choose Laminate Finish
- Choose ABS Edge Finish
- Choose Metal Finish
- Choose Paint Finish, if -PS Slab Base is specified
- Choose Veneer Finish, if -V Slab Base is specified



# LAMINATE TOP WITH ABS SQUARE EDGE



D-SHAPE TOP

**BASE KEY**

OF Open Frame

RCL Laminate Racetrack Base  
RCP Painted Racetrack Base  
RCV Veneer Racetrack Base

**D-SHAPE TOP // SLAB BASE // STANDING HEIGHT**

MODEL #	LENGTH	WIDTH	HEIGHT	SEATING CAPACITY	-OF	-RCL	-RCP	-RCV
TFN-3060-PE [ ]	60	30	42	5	3,573	-	-	-
TFN-3066-PE [ ]	66	30	42	5	3,888	-	-	-
TFN-3072-PE [ ]	72	30	42	5	4,005	-	-	-
TFN-3078-PE [ ]	78	30	42	5	4,407	-	-	-
TFN-3084-PE [ ]	84	30	42	7	4,532	-	-	-
TFN-3090-PE [ ]	90	30	42	7	4,897	-	-	-
TFN-3096-PE [ ]	96	30	42	7	5,028	-	-	-
TFN-3660-PE [ ]	60	36	42	5	3,749	-	-	-
TFN-3666-PE [ ]	66	36	42	5	4,092	-	-	-
TFN-3672-PE [ ]	72	36	42	5	4,227	-	-	-
TFN-3678-PE [ ]	78	36	42	5	4,665	-	-	-
TFN-3684-PE [ ]	84	36	42	7	4,809	-	-	-
TFN-3690-PE [ ]	90	36	42	7	5,211	-	-	-
TFN-3696-PE [ ]	96	36	42	7	5,362	-	-	-
TFN-4260-PE [ ]	60	42	42	5	4,268	-	-	-
TFN-4266-PE [ ]	66	42	42	5	4,673	-	-	-
TFN-4272-PE [ ]	72	42	42	5	4,839	4,839	5,204	5,520
TFN-4278-PE [ ]	78	42	42	5	5,353	5,353	5,745	6,082
TFN-4284-PE [ ]	84	42	42	7	5,532	5,532	5,923	6,260
TFN-4290-PE [ ]	90	42	42	7	6,007	6,007	6,419	6,773
TFN-4296-PE [ ]	96	42	42	7	6,195	6,195	6,606	6,961
TFN-4860-PE [ ]	60	48	42	5	4,613	-	-	-
TFN-4866-PE [ ]	66	48	42	5	5,063	-	-	-
TFN-4872-PE [ ]	72	48	42	5	5,256	5,256	5,635	5,961
TFN-4878-PE [ ]	78	48	42	5	5,829	5,829	6,233	6,581
TFN-4884-PE [ ]	84	48	42	7	6,035	6,035	6,440	6,788
TFN-4890-PE [ ]	90	48	42	7	6,566	6,566	6,991	7,359
TFN-4896-PE [ ]	96	48	42	7	6,784	6,784	7,210	7,576

[ ] Slab Base, Specify Paint (-PS) or Veneer (-V)

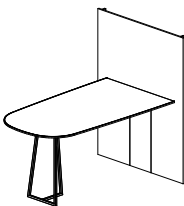

Shown with optional Monitor Panel (-MP)

**OPTIONS**

Power & Data Options

See pages 123-133

Remove Slab Base

Add **-WM**

Deduct \$672

Mounted directly to wall

**Polished Chrome Finish Options:**

Polished Chrome Open Frame Base

Add **-PCOF-TWD**

\$1,590

**Monitor Panel Options:**

42"-Wide Monitor Panel

Add **-MP30**

\$1,996

For use with 30"-Wide Tables

48"-Wide Monitor Panel

Add **-MP36**

\$2,200

For use with 36"-Wide Tables

54"-Wide Monitor Panel

Add **-MP42**

\$2,405

For use with 42"-Wide Tables

60"-Wide Monitor Panel

Add **-MP48**

\$2,612

For use with 48"-Wide Tables

**EDGE PROFILE**



Two4Six Square Edge

**GENERAL INFORMATION**

- Tops are 1-1/8"-thick
- Seating capacity based on 27" per person
- Overall table height 42"
- Standard with quarter cut veneer
- Must be anchored to a wall, with or without Slab Base
- One section of wire management channel provided per table
- Monitor Panel will be 12" wider than the table specified
- Monitor Panel mounts directly to the wall
- Monitor Panel is 78" high
- Monitor panel available in Paint or Veneer Finish options only
- Not available with Power Matrix
- Only Woodgrain Laminate options are available for the Racetrack Base
- Racetrack Bases have a removable access door

**REQUIRED INFORMATION (ORDER CANNOT BE ENTERED WITHOUT THIS INFORMATION)**

See appendix pages vi-vii for surface material options.

- Choose Laminate Finish
- Choose ABS Edge Finish
- Choose Metal Finish
- Choose Paint Finish, if -PS Slab Base is specified
- Choose Veneer Finish, if -V Slab Base is specified



# GLASS TOP



D-SHAPE TOP

### BASE KEY

OF Open Frame

RCL Laminate Racetrack Base  
RCP Painted Racetrack Base  
RCV Veneer Racetrack Base

## D-SHAPE TOP // SLAB BASE // STANDING HEIGHT

MODEL #	LENGTH	WIDTH	HEIGHT	SEATING CAPACITY	-OF	-RCL	-RCP	-RCV
TFN-3060-G [ ]	60	30	42	5	6,206	-	-	-
TFN-3066-G [ ]	66	30	42	5	6,754	-	-	-
TFN-3072-G [ ]	72	30	42	5	6,957	-	-	-
TFN-3078-G [ ]	78	30	42	5	7,655	-	-	-
TFN-3084-G [ ]	84	30	42	7	7,872	-	-	-
TFN-3090-G [ ]	90	30	42	7	8,507	-	-	-
TFN-3096-G [ ]	96	30	42	7	8,735	-	-	-
TFN-3660-G [ ]	60	36	42	5	6,512	-	-	-
TFN-3666-G [ ]	66	36	42	5	7,108	-	-	-
TFN-3672-G [ ]	72	36	42	5	7,343	-	-	-
TFN-3678-G [ ]	78	36	42	5	8,103	-	-	-
TFN-3684-G [ ]	84	36	42	7	8,354	-	-	-
TFN-3690-G [ ]	90	36	42	7	9,052	-	-	-
TFN-3696-G [ ]	96	36	42	7	9,315	-	-	-
TFN-4260-G [ ]	60	42	42	5	7,414	-	-	-
TFN-4266-G [ ]	66	42	42	5	8,117	-	-	-
TFN-4272-G [ ]	72	42	42	5	8,406	8,406	9,041	9,588
TFN-4278-G [ ]	78	42	42	5	9,300	9,300	9,980	10,565
TFN-4284-G [ ]	84	42	42	7	9,610	9,610	10,289	10,874
TFN-4290-G [ ]	90	42	42	7	10,435	10,435	11,150	11,766
TFN-4296-G [ ]	96	42	42	7	10,761	10,761	11,476	12,092
TFN-4860-G [ ]	60	48	42	5	8,013	-	-	-
TFN-4866-G [ ]	66	48	42	5	8,794	-	-	-
TFN-4872-G [ ]	72	48	42	5	9,131	9,131	9,788	10,354
TFN-4878-G [ ]	78	48	42	5	10,125	10,125	10,827	11,432
TFN-4884-G [ ]	84	48	42	7	10,484	10,484	11,187	11,793
TFN-4890-G [ ]	90	48	42	7	11,406	11,406	12,145	12,783
TFN-4896-G [ ]	96	48	42	7	11,785	11,785	12,524	13,161

[ ] Slab Base, Specify Paint (-PS) or Veneer (-V)

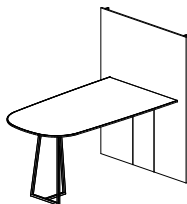

Shown with optional Monitor Panel (-MP)

### OPTIONS

Power & Data Options

See pages 123-133

Remove Slab Base

Add **-WM**

Deduct \$672

Mounted directly to wall

### Polished Chrome Finish Options:

Polished Chrome Open Frame Base

Add **-PCOF-TWD**

\$1,590

### Satin Glass Options:

Satin Glass

Add **-TFSG**

\$635

### Monitor Panel Options:

42"-Wide Monitor Panel

Add **-MP30**

\$1,996

For use with 30"-Wide Tables

48"-Wide Monitor Panel

Add **-MP36**

\$2,200

For use with 36"-Wide Tables

54"-Wide Monitor Panel

Add **-MP42**

\$2,405

For use with 42"-Wide Tables

60"-Wide Monitor Panel

Add **-MP48**

\$2,612

For use with 48"-Wide Tables

### EDGE PROFILE



Two4Six Glass Edge

### GENERAL INFORMATION

- Tops are 1-1/8"-thick with 3/16"-thick hardwood edge band
- Seating capacity based on 27" per person
- Overall table height 42"
- Standard with quarter cut veneer
- Must be anchored to a wall, with or without Slab Base
- One section of wire management channel provided per table
- Monitor Panel will be 12" wider than the table specified

- Monitor Panel mounts directly to the wall
- Monitor Panel is 78" high
- Monitor panel available in Paint or Veneer Finish options only
- Not available with Power Matrix
- Only Woodgrain Laminate options are available for the Racetrack Base
- Racetrack Bases have a removable access door

### REQUIRED INFORMATION (ORDER CANNOT BE ENTERED WITHOUT THIS INFORMATION)

See appendix pages vi-vii for surface material options.

- Choose Glass Finish
- Choose Paint Finish, if -PS Slab Base is specified
- Choose Veneer Finish, if -V Slab Base is specified
- Choose Metal Finish
- Choose Sub-Top Finish: Paint Finish or Wood Species & Finish



# SOLID SURFACE TOP



D-SHAPE TOP

### BASE KEY

OF Open Frame

RCL Laminate Racetrack Base  
RCP Painted Racetrack Base  
RCV Veneer Racetrack Base

## D-SHAPE TOP // SLAB BASE // STANDING HEIGHT

MODEL #	LENGTH	WIDTH	HEIGHT	SEATING CAPACITY	-OF	-RCL	-RCP	-RCV
TFN-3060-SS [ ]	60	30	42	5	6,485	-	-	-
TFN-3066-SS [ ]	66	30	42	5	7,057	-	-	-
TFN-3072-SS [ ]	72	30	42	5	7,269	-	-	-
TFN-3078-SS [ ]	78	30	42	5	7,999	-	-	-
TFN-3084-SS [ ]	84	30	42	7	8,225	-	-	-
TFN-3090-SS [ ]	90	30	42	7	8,889	-	-	-
TFN-3096-SS [ ]	96	30	42	7	9,127	-	-	-
TFN-3660-SS [ ]	60	36	42	5	6,804	-	-	-
TFN-3666-SS [ ]	66	36	42	5	7,427	-	-	-
TFN-3672-SS [ ]	72	36	42	5	7,673	-	-	-
TFN-3678-SS [ ]	78	36	42	5	8,467	-	-	-
TFN-3684-SS [ ]	84	36	42	7	8,729	-	-	-
TFN-3690-SS [ ]	90	36	42	7	9,458	-	-	-
TFN-3696-SS [ ]	96	36	42	7	9,733	-	-	-
TFN-4260-SS [ ]	60	42	42	5	7,746	-	-	-
TFN-4266-SS [ ]	66	42	42	5	8,481	-	-	-
TFN-4272-SS [ ]	72	42	42	5	8,783	8,783	9,446	10,018
TFN-4278-SS [ ]	78	42	42	5	9,717	9,717	10,428	11,039
TFN-4284-SS [ ]	84	42	42	7	10,041	10,041	10,750	11,362
TFN-4290-SS [ ]	90	42	42	7	10,904	10,904	11,650	12,294
TFN-4296-SS [ ]	96	42	42	7	11,244	11,244	11,991	12,635
TFN-4860-SS [ ]	60	48	42	5	8,372	-	-	-
TFN-4866-SS [ ]	66	48	42	5	9,189	-	-	-
TFN-4872-SS [ ]	72	48	42	5	9,541	9,541	10,227	10,819
TFN-4878-SS [ ]	78	48	42	5	10,579	10,579	11,313	11,945
TFN-4884-SS [ ]	84	48	42	7	10,954	10,954	11,689	12,322
TFN-4890-SS [ ]	90	48	42	7	11,917	11,917	12,690	13,357
TFN-4896-SS [ ]	96	48	42	7	12,314	12,314	13,086	13,751

[ ] Slab Base, Specify Paint (-PS) or Veneer (-V)

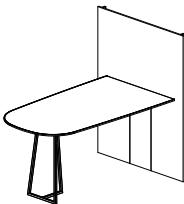

Shown with optional Monitor Panel (-MP)

### OPTIONS

Power & Data Options

### CODE

### PRICE

### NOTES

See pages 123-133

Remove Slab Base

Add **-WM**

Deduct \$672

Mounted directly to wall

### Polished Chrome Finish Options:

Polished Chrome Open Frame Base

Add **-PCOF-TWD**

\$1,590

### Monitor Panel Options:

42"-Wide Monitor Panel

Add **-MP30**

\$1,996

For use with 30"-Wide Tables

48"-Wide Monitor Panel

Add **-MP36**

\$2,200

For use with 36"-Wide Tables

54"-Wide Monitor Panel

Add **-MP42**

\$2,405

For use with 42"-Wide Tables

60"-Wide Monitor Panel

Add **-MP48**

\$2,612

For use with 48"-Wide Tables

### EDGE PROFILE

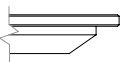

Two4Six Solid Surface Edge

### GENERAL INFORMATION

- Seating capacity based on 27" per person
- Overall table height 42"
- Standard with quarter cut veneer
- Must be anchored to a wall, with or without Slab Base
- One section of wire management channel provided per table
- Monitor Panel will be 12" wider than the table specified

- Monitor Panel mounts directly to the wall
- Monitor Panel is 78" high
- Monitor panel available in Paint or Veneer Finish options only
- Not available with Power Matrix
- Only Woodgrain Laminate options are available for the Racetrack Base
- Racetrack Bases have a removable access door

### REQUIRED INFORMATION (ORDER CANNOT BE ENTERED WITHOUT THIS INFORMATION)

See appendix pages vi-vii for surface material options.

- Choose Solid Surface Finish
- Choose Paint Finish, if -PS Slab Base is specified
- Choose Veneer Finish, if -V Slab Base is specified
- Choose Metal Finish



# VENEER TOP WITH HARDWOOD EDGE



RECTANGLE TOP

**BASE KEY**

OF Open Frame

RCL Laminate Racetrack Base  
 RCP Painted Racetrack Base  
 RCV Veneer Racetrack Base

**RECTANGLE TOP TABLES**

MODEL #	LENGTH	WIDTH	HEIGHT	SEATING CAPACITY	-OF	-RCL	-RCP	-RCV
TFP-3060-V	60	30	42	4	4,183	-	-	-
TFP-3660-V	60	36	42	4	4,379	-	-	-
TFP-4260-V	60	42	42	4	4,974	-	-	-
TFP-4860-V	60	48	42	4	5,366	-	-	-
TFP-3066-V	66	30	42	4	4,545	-	-	-
TFP-3666-V	66	36	42	4	4,772	-	-	-
TFP-4266-V	66	42	42	4	5,437	-	-	-
TFP-4866-V	66	48	42	4	5,880	-	-	-
TFP-3072-V	72	30	42	6	4,675	-	-	-
TFP-3672-V	72	36	42	6	4,923	-	-	-
TFP-4272-V	72	42	42	6	5,623	5,623	6,011	6,406
TFP-4872-V	72	48	42	6	6,096	6,096	6,498	6,906
TFP-3078-V	78	30	42	6	5,138	-	-	-
TFP-3678-V	78	36	42	6	5,425	-	-	-
TFP-4278-V	78	42	42	6	6,212	6,212	6,628	7,050
TFP-4878-V	78	48	42	6	6,750	6,750	7,179	7,616
TFP-3084-V	84	30	42	8	5,277	-	-	-
TFP-3684-V	84	36	42	8	5,586	-	-	-
TFP-4284-V	84	42	42	8	6,411	6,411	6,826	7,248
TFP-4884-V	84	48	42	8	6,980	6,980	7,410	7,847
TFP-3090-V	90	30	42	8	5,696	-	-	-
TFP-3690-V	90	36	42	8	6,045	-	-	-
TFP-4290-V	90	42	42	8	6,953	6,953	7,390	7,834
TFP-4890-V	90	48	42	8	7,585	7,585	8,037	8,496
TFP-3096-V	96	30	42	8	5,842	-	-	-
TFP-3696-V	96	36	42	8	6,214	-	-	-
TFP-4296-V	96	42	42	8	7,162	7,162	7,599	8,043
TFP-4896-V	96	48	42	8	7,827	7,827	8,279	8,738
TFP-42102-V	102	42	42	8	-	7,780	8,241	8,710
TFP-48102-V	102	48	42	8	-	8,518	8,995	9,480
TFP-42108-V	108	42	42	10	-	8,001	8,462	8,930
TFP-48108-V	108	48	42	10	-	8,774	9,251	9,736
TFP-42114-V	114	42	42	10	-	8,654	9,140	9,633
TFP-48114-V	114	48	42	10	-	9,504	10,006	10,516
TFP-42120-V	120	42	42	10	-	8,886	9,372	9,865
TFP-48120-V	120	48	42	10	-	9,774	10,276	10,786
TFP-42132-V	132	42	42	10	-	9,740	10,246	10,759
TFP-48132-V	132	48	42	10	-	10,741	11,265	11,796
TFP-42144-V	144	42	42	12	-	10,633	11,159	11,693
TFP-48144-V	144	48	42	12	-	11,755	12,299	12,852





# VENEER TOP WITH HARDWOOD EDGE

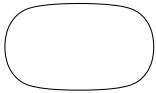

SOFT RECTANGLE TOP

**BASE KEY**

OF Open Frame

RCL Laminate Racetrack Base  
 RCP Painted Racetrack Base  
 RCV Veneer Racetrack Base

**SOFT RECTANGLE TOP TABLES**

MODEL #	LENGTH	WIDTH	HEIGHT	SEATING CAPACITY	-OF	-RCL	-RCP	-RCV
TFV-3060-V	60	30	42	4	4,183	-	-	-
TFV-3660-V	60	36	42	4	4,379	-	-	-
TFV-4260-V	60	42	42	4	4,974	-	-	-
TFV-4860-V	60	48	42	4	5,366	-	-	-
TFV-3066-V	66	30	42	4	4,545	-	-	-
TFV-3666-V	66	36	42	4	4,772	-	-	-
TFV-4266-V	66	42	42	4	5,437	-	-	-
TFV-4866-V	66	48	42	4	5,880	-	-	-
TFV-3072-V	72	30	42	6	4,675	-	-	-
TFV-3672-V	72	36	42	6	4,923	-	-	-
TFV-4272-V	72	42	42	6	5,623	5,623	6,011	6,406
TFV-4872-V	72	48	42	6	6,096	6,096	6,498	6,906
TFV-3078-V	78	30	42	6	5,138	-	-	-
TFV-3678-V	78	36	42	6	5,425	-	-	-
TFV-4278-V	78	42	42	6	6,212	6,212	6,628	7,050
TFV-4878-V	78	48	42	6	6,750	6,750	7,179	7,616
TFV-3084-V	84	30	42	8	5,277	-	-	-
TFV-3684-V	84	36	42	8	5,586	-	-	-
TFV-4284-V	84	42	42	8	6,411	6,411	6,826	7,248
TFV-4884-V	84	48	42	8	6,980	6,980	7,410	7,847
TFV-3090-V	90	30	42	8	5,696	-	-	-
TFV-3690-V	90	36	42	8	6,045	-	-	-
TFV-4290-V	90	42	42	8	6,953	6,953	7,390	7,834
TFV-4890-V	90	48	42	8	7,585	7,585	8,037	8,496
TFV-3096-V	96	30	42	8	5,842	-	-	-
TFV-3696-V	96	36	42	8	6,214	-	-	-
TFV-4296-V	96	42	42	8	7,162	7,162	7,599	8,043
TFV-4896-V	96	48	42	8	7,827	7,827	8,279	8,738
TFV-42102-V	102	42	42	8	-	7,780	8,241	8,710
TFV-48102-V	102	48	42	8	-	8,518	8,995	9,480
TFV-42108-V	108	42	42	10	-	8,001	8,462	8,930
TFV-48108-V	108	48	42	10	-	8,774	9,251	9,736
TFV-42114-V	114	42	42	10	-	8,654	9,140	9,633
TFV-48114-V	114	48	42	10	-	9,504	10,006	10,516
TFV-42120-V	120	42	42	10	-	8,886	9,372	9,865
TFV-48120-V	120	48	42	10	-	9,774	10,276	10,786
TFV-42132-V	132	42	42	10	-	9,740	10,246	10,759
TFV-48132-V	132	48	42	10	-	10,741	11,265	11,796
TFV-42144-V	144	42	42	12	-	10,633	11,159	11,693
TFV-48144-V	144	48	42	12	-	11,755	12,299	12,852



# VENEER TOP WITH HARDWOOD EDGE

OPTIONS	CODE	PRICE	NOTES
Power & Data Options			See pages 123-133
<b>Polished Chrome Finish Options:</b>			
Polished Chrome Open Frame Base	Add -PCOF-TWE	\$2,612	
<b>Multi-Section Tops:</b>			
102", 108", 114" and 120" one-piece tops split into two sections	Specify -2	\$764	Note: Power Matrix (center of table location only) cannot be specified when this option is selected

## EDGE PROFILE

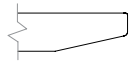

Two4Six Cutback Edge

## GENERAL INFORMATION

- Seating capacity based on 27" per person
- Overall table height 42"
- Standard with quarter cut veneer
- One section of wire management channel provided per table
- Racetrack Bases have a removable access door

### REQUIRED INFORMATION (ORDER CANNOT BE ENTERED WITHOUT THIS INFORMATION)

See appendix pages vi-vii for surface material options.

- Choose Veneer Finish
- Choose Metal Finish



# INSET LAMINATE TOP WITH HARDWOOD EDGE



RECTANGLE TOP

**BASE KEY**

OF Open Frame

RCL Laminate Racetrack Base  
 RCP Painted Racetrack Base  
 RCV Veneer Racetrack Base

**RECTANGLE TOP TABLES**

MODEL #	LENGTH	WIDTH	HEIGHT	SEATING CAPACITY	-OF	-RCL	-RCP	-RCV
TFP-3060-P	60	30	42	4	3,953	-	-	-
TFP-3660-P	60	36	42	4	4,139	-	-	-
TFP-4260-P	60	42	42	4	4,701	-	-	-
TFP-4860-P	60	48	42	4	5,071	-	-	-
TFP-3066-P	66	30	42	4	4,296	-	-	-
TFP-3666-P	66	36	42	4	4,510	-	-	-
TFP-4266-P	66	42	42	4	5,138	-	-	-
TFP-4866-P	66	48	42	4	5,557	-	-	-
TFP-3072-P	72	30	42	6	4,418	-	-	-
TFP-3672-P	72	36	42	6	4,653	-	-	-
TFP-4272-P	72	42	42	6	5,314	5,314	5,681	6,054
TFP-4872-P	72	48	42	6	5,761	5,761	6,141	6,527
TFP-3078-P	78	30	42	6	4,856	-	-	-
TFP-3678-P	78	36	42	6	5,127	-	-	-
TFP-4278-P	78	42	42	6	5,871	5,871	6,264	6,663
TFP-4878-P	78	48	42	6	6,379	6,379	6,785	7,198
TFP-3084-P	84	30	42	8	4,987	-	-	-
TFP-3684-P	84	36	42	8	5,279	-	-	-
TFP-4284-P	84	42	42	8	6,059	6,059	6,451	6,850
TFP-4884-P	84	48	42	8	6,597	6,597	7,003	7,416
TFP-3090-P	90	30	42	8	5,383	-	-	-
TFP-3690-P	90	36	42	8	5,713	-	-	-
TFP-4290-P	90	42	42	8	6,571	6,571	6,984	7,404
TFP-4890-P	90	48	42	8	7,168	7,168	7,595	8,029
TFP-3096-P	96	30	42	8	5,521	-	-	-
TFP-3696-P	96	36	42	8	5,873	-	-	-
TFP-4296-P	96	42	42	8	6,769	6,769	7,182	7,601
TFP-4896-P	96	48	42	8	7,397	7,397	7,824	8,258
TFP-42102-P	102	42	42	8	-	7,353	7,788	8,231
TFP-48102-P	102	48	42	8	-	8,050	8,501	8,959
TFP-42108-P	108	42	42	10	-	7,561	7,997	8,439
TFP-48108-P	108	48	42	10	-	8,292	8,743	9,201
TFP-42114-P	114	42	42	10	-	8,179	8,638	9,104
TFP-48114-P	114	48	42	10	-	8,982	9,456	9,938
TFP-42120-P	120	42	42	10	-	8,398	8,857	9,323
TFP-48120-P	120	48	42	10	-	9,237	9,711	10,193
TFP-42132-P	132	42	42	10	-	9,205	9,683	10,168
TFP-48132-P	132	48	42	10	-	10,151	10,646	11,148
TFP-42144-P	144	42	42	12	-	10,049	10,546	11,050
TFP-48144-P	144	48	42	12	-	11,109	11,623	12,146



# INSET LAMINATE TOP WITH HARDWOOD EDGE

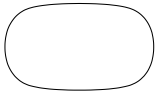

SOFT RECTANGLE TOP

**BASE KEY**

OF Open Frame

RCL Laminate Racetrack Base  
 RCP Painted Racetrack Base  
 RCV Veneer Racetrack Base

**SOFT RECTANGLE TOP TABLES**

MODEL #	LENGTH	WIDTH	HEIGHT	SEATING CAPACITY	-OF	-RCL	-RCP	-RCV
TFV-3060-P	60	30	42	4	3,953	-	-	-
TFV-3660-P	60	36	42	4	4,139	-	-	-
TFV-4260-P	60	42	42	4	4,701	-	-	-
TFV-4860-P	60	48	42	4	5,071	-	-	-
TFV-3066-P	66	30	42	4	4,296	-	-	-
TFV-3666-P	66	36	42	4	4,510	-	-	-
TFV-4266-P	66	42	42	4	5,138	-	-	-
TFV-4866-P	66	48	42	4	5,557	-	-	-
TFV-3072-P	72	30	42	6	4,418	-	-	-
TFV-3672-P	72	36	42	6	4,653	-	-	-
TFV-4272-P	72	42	42	6	5,314	5,314	5,681	6,054
TFV-4872-P	72	48	42	6	5,761	5,761	6,141	6,527
TFV-3078-P	78	30	42	6	4,856	-	-	-
TFV-3678-P	78	36	42	6	5,127	-	-	-
TFV-4278-P	78	42	42	6	5,871	5,871	6,264	6,663
TFV-4878-P	78	48	42	6	6,379	6,379	6,785	7,198
TFV-3084-P	84	30	42	8	4,987	-	-	-
TFV-3684-P	84	36	42	8	5,279	-	-	-
TFV-4284-P	84	42	42	8	6,059	6,059	6,451	6,850
TFV-4884-P	84	48	42	8	6,597	6,597	7,003	7,416
TFV-3090-P	90	30	42	8	5,383	-	-	-
TFV-3690-P	90	36	42	8	5,713	-	-	-
TFV-4290-P	90	42	42	8	6,571	6,571	6,984	7,404
TFV-4890-P	90	48	42	8	7,168	7,168	7,595	8,029
TFV-3096-P	96	30	42	8	5,521	-	-	-
TFV-3696-P	96	36	42	8	5,873	-	-	-
TFV-4296-P	96	42	42	8	6,769	6,769	7,182	7,601
TFV-4896-P	96	48	42	8	7,397	7,397	7,824	8,258
TFV-42102-P	102	42	42	8	-	7,353	7,788	8,231
TFV-48102-P	102	48	42	8	-	8,050	8,501	8,959
TFV-42108-P	108	42	42	10	-	7,561	7,997	8,439
TFV-48108-P	108	48	42	10	-	8,292	8,743	9,201
TFV-42114-P	114	42	42	10	-	8,179	8,638	9,104
TFV-48114-P	114	48	42	10	-	8,982	9,456	9,938
TFV-42120-P	120	42	42	10	-	8,398	8,857	9,323
TFV-48120-P	120	48	42	10	-	9,237	9,711	10,193
TFV-42132-P	132	42	42	10	-	9,205	9,683	10,168
TFV-48132-P	132	48	42	10	-	10,151	10,646	11,148
TFV-42144-P	144	42	42	12	-	10,049	10,546	11,050
TFV-48144-P	144	48	42	12	-	11,109	11,623	12,146



# INSET LAMINATE TOP WITH HARDWOOD EDGE

OPTIONS	CODE	PRICE	NOTES
Power & Data Options			See pages 123-133
<b>Polished Chrome Finish Options:</b>			
Polished Chrome Open Frame Base	Add -PCOF-TWE	\$2,612	
<b>Multi-Section Tops:</b>			
102", 108", 114" and 120" one-piece tops split into two sections	Specify -2	\$764	Note: Power Matrix (center of table location only) cannot be specified when this option is selected

## EDGE PROFILE

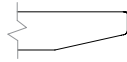

Two4Six Cutback Edge

## GENERAL INFORMATION

- Seating capacity based on 27" per person
- Overall table height 42"
- Standard with quarter cut veneer
- One section of wire management channel provided per table
- Racetrack Bases have a removable access door

### REQUIRED INFORMATION (ORDER CANNOT BE ENTERED WITHOUT THIS INFORMATION)

See appendix pages vi-vii for surface material options.

- Choose Laminate Finish
- Choose Wood Species & Finish for Hardwood Edge
- Choose Metal Finish



## LAMINATE TOP WITH ABS CUTBACK EDGE



RECTANGLE TOP

## BASE KEY

OF Open Frame

RCL Laminate Racetrack Base  
RCP Painted Racetrack Base  
RCV Veneer Racetrack Base

## RECTANGLE TOP TABLES

MODEL #	LENGTH	WIDTH	HEIGHT	SEATING CAPACITY	-OF	-RCL	-RCP	-RCV
TFP-3060-PA	60	30	42	4	3,953	-	-	-
TFP-3660-PA	60	36	42	4	4,139	-	-	-
TFP-4260-PA	60	42	42	4	4,701	-	-	-
TFP-4860-PA	60	48	42	4	5,071	-	-	-
TFP-3066-PA	66	30	42	4	4,296	-	-	-
TFP-3666-PA	66	36	42	4	4,510	-	-	-
TFP-4266-PA	66	42	42	4	5,138	-	-	-
TFP-4866-PA	66	48	42	4	5,557	-	-	-
TFP-3072-PA	72	30	42	6	4,418	-	-	-
TFP-3672-PA	72	36	42	6	4,653	-	-	-
TFP-4272-PA	72	42	42	6	5,314	5,314	5,681	6,054
TFP-4872-PA	72	48	42	6	5,761	5,761	6,141	6,527
TFP-3078-PA	78	30	42	6	4,856	-	-	-
TFP-3678-PA	78	36	42	6	5,127	-	-	-
TFP-4278-PA	78	42	42	6	5,871	5,871	6,264	6,663
TFP-4878-PA	78	48	42	6	6,379	6,379	6,785	7,198
TFP-3084-PA	84	30	42	8	4,987	-	-	-
TFP-3684-PA	84	36	42	8	5,279	-	-	-
TFP-4284-PA	84	42	42	8	6,059	6,059	6,451	6,850
TFP-4884-PA	84	48	42	8	6,597	6,597	7,003	7,416
TFP-3090-PA	90	30	42	8	5,383	-	-	-
TFP-3690-PA	90	36	42	8	5,713	-	-	-
TFP-4290-PA	90	42	42	8	6,571	6,571	6,984	7,404
TFP-4890-PA	90	48	42	8	7,168	7,168	7,595	8,029
TFP-3096-PA	96	30	42	8	5,521	-	-	-
TFP-3696-PA	96	36	42	8	5,873	-	-	-
TFP-4296-PA	96	42	42	8	6,769	6,769	7,182	7,601
TFP-4896-PA	96	48	42	8	7,397	7,397	7,824	8,258
TFP-42102-PA	102	42	42	8	-	7,353	7,788	8,231
TFP-48102-PA	102	48	42	8	-	8,050	8,501	8,959
TFP-42108-PA	108	42	42	10	-	7,561	7,997	8,439
TFP-48108-PA	108	48	42	10	-	8,292	8,743	9,201
TFP-42114-PA	114	42	42	10	-	8,179	8,638	9,104
TFP-48114-PA	114	48	42	10	-	8,982	9,456	9,938
TFP-42120-PA	120	42	42	10	-	8,398	8,857	9,323
TFP-48120-PA	120	48	42	10	-	9,237	9,711	10,193
TFP-42132-PA	132	42	42	10	-	9,205	9,683	10,168
TFP-48132-PA	132	48	42	10	-	10,151	10,646	11,148
TFP-42144-PA	144	42	42	12	-	10,049	10,546	11,050
TFP-48144-PA	144	48	42	12	-	11,109	11,623	12,146



## LAMINATE TOP WITH ABS CUTBACK EDGE

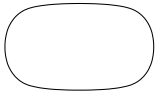

SOFT RECTANGLE TOP

## BASE KEY

OF Open Frame

RCL Laminate Racetrack Base  
RCP Painted Racetrack Base  
RCV Veneer Racetrack Base

## SOFT RECTANGLE TOP TABLES

MODEL #	LENGTH	WIDTH	HEIGHT	SEATING CAPACITY	-OF	-RCL	-RCP	-RCV
TFV-3060-PA	60	30	42	4	3,953	-	-	-
TFV-3660-PA	60	36	42	4	4,139	-	-	-
TFV-4260-PA	60	42	42	4	4,701	-	-	-
TFV-4860-PA	60	48	42	4	5,071	-	-	-
TFV-3066-PA	66	30	42	4	4,296	-	-	-
TFV-3666-PA	66	36	42	4	4,510	-	-	-
TFV-4266-PA	66	42	42	4	5,138	-	-	-
TFV-4866-PA	66	48	42	4	5,557	-	-	-
TFV-3072-PA	72	30	42	6	4,418	-	-	-
TFV-3672-PA	72	36	42	6	4,653	-	-	-
TFV-4272-PA	72	42	42	6	5,314	5,314	5,681	6,054
TFV-4872-PA	72	48	42	6	5,761	5,761	6,141	6,527
TFV-3078-PA	78	30	42	6	4,856	-	-	-
TFV-3678-PA	78	36	42	6	5,127	-	-	-
TFV-4278-PA	78	42	42	6	5,871	5,871	6,264	6,663
TFV-4878-PA	78	48	42	6	6,379	6,379	6,785	7,198
TFV-3084-PA	84	30	42	8	4,987	-	-	-
TFV-3684-PA	84	36	42	8	5,279	-	-	-
TFV-4284-PA	84	42	42	8	6,059	6,059	6,451	6,850
TFV-4884-PA	84	48	42	8	6,597	6,597	7,003	7,416
TFV-3090-PA	90	30	42	8	5,383	-	-	-
TFV-3690-PA	90	36	42	8	5,713	-	-	-
TFV-4290-PA	90	42	42	8	6,571	6,571	6,984	7,404
TFV-4890-PA	90	48	42	8	7,168	7,168	7,595	8,029
TFV-3096-PA	96	30	42	8	5,521	-	-	-
TFV-3696-PA	96	36	42	8	5,873	-	-	-
TFV-4296-PA	96	42	42	8	6,769	6,769	7,182	7,601
TFV-4896-PA	96	48	42	8	7,397	7,397	7,824	8,258
TFV-42102-PA	102	42	42	8	-	7,353	7,788	8,231
TFV-48102-PA	102	48	42	8	-	8,050	8,501	8,959
TFV-42108-PA	108	42	42	10	-	7,561	7,997	8,439
TFV-48108-PA	108	48	42	10	-	8,292	8,743	9,201
TFV-42114-PA	114	42	42	10	-	8,179	8,638	9,104
TFV-48114-PA	114	48	42	10	-	8,982	9,456	9,938
TFV-42120-PA	120	42	42	10	-	8,398	8,857	9,323
TFV-48120-PA	120	48	42	10	-	9,237	9,711	10,193
TFV-42132-PA	132	42	42	10	-	9,205	9,683	10,168
TFV-48132-PA	132	48	42	10	-	10,151	10,646	11,148
TFV-42144-PA	144	42	42	12	-	10,049	10,546	11,050
TFV-48144-PA	144	48	42	12	-	11,109	11,623	12,146



# LAMINATE TOP WITH ABS CUTBACK EDGE

OPTIONS	CODE	PRICE	NOTES
Power & Data Options			See pages 123-133
<b>Polished Chrome Finish Options:</b>			
Polished Chrome Open Frame Base	Add -PCOF-TWE	\$2,612	
<b>Multi-Section Tops:</b>			
102", 108", 114" and 120" one-piece tops split into two sections	Specify -2	\$764	Note: Power Matrix (center of table location only) cannot be specified when this option is selected

## EDGE PROFILE

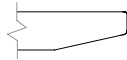

Two4Six Cutback Edge

## GENERAL INFORMATION

- Seating capacity based on 27" per person
- Overall table height 42"
- Standard with quarter cut veneer
- One section of wire management channel provided per table
- Racetrack Bases have a removable access door

### REQUIRED INFORMATION (ORDER CANNOT BE ENTERED WITHOUT THIS INFORMATION)

See appendix pages vi-vii for surface material options.

- Choose Laminate Finish
- Choose ABS Edge Finish
- Choose Metal Finish





## LAMINATE TOP WITH ABS SQUARE EDGE



RECTANGLE TOP

## BASE KEY

OF Open Frame

RCL Laminate Racetrack Base

RCP Painted Racetrack Base

RCV Veneer Racetrack Base

## RECTANGLE TOP TABLES

MODEL #	LENGTH	WIDTH	HEIGHT	SEATING CAPACITY	-OF	-RCL	-RCP	-RCV
TFP-3060-PE	60	30	42	4	3,556	-	-	-
TFP-3660-PE	60	36	42	4	3,723	-	-	-
TFP-4260-PE	60	42	42	4	4,228	-	-	-
TFP-4860-PE	60	48	42	4	4,562	-	-	-
TFP-3066-PE	66	30	42	4	3,864	-	-	-
TFP-3666-PE	66	36	42	4	4,057	-	-	-
TFP-4266-PE	66	42	42	4	4,622	-	-	-
TFP-4866-PE	66	48	42	4	4,998	-	-	-
TFP-3072-PE	72	30	42	6	3,974	-	-	-
TFP-3672-PE	72	36	42	6	4,185	-	-	-
TFP-4272-PE	72	42	42	6	4,780	4,780	5,110	5,446
TFP-4872-PE	72	48	42	6	5,182	5,182	5,524	5,871
TFP-3078-PE	78	30	42	6	4,368	-	-	-
TFP-3678-PE	78	36	42	6	4,612	-	-	-
TFP-4278-PE	78	42	42	6	5,281	5,281	5,634	5,993
TFP-4878-PE	78	48	42	6	5,738	5,738	6,103	6,474
TFP-3084-PE	84	30	42	8	4,486	-	-	-
TFP-3684-PE	84	36	42	8	4,749	-	-	-
TFP-4284-PE	84	42	42	8	5,450	5,450	5,803	6,161
TFP-4884-PE	84	48	42	8	5,933	5,933	6,299	6,670
TFP-3090-PE	90	30	42	8	4,842	-	-	-
TFP-3690-PE	90	36	42	8	5,139	-	-	-
TFP-4290-PE	90	42	42	8	5,911	5,911	6,282	6,659
TFP-4890-PE	90	48	42	8	6,448	6,448	6,832	7,222
TFP-3096-PE	96	30	42	8	4,966	-	-	-
TFP-3696-PE	96	36	42	8	5,282	-	-	-
TFP-4296-PE	96	42	42	8	6,088	6,088	6,460	6,837
TFP-4896-PE	96	48	42	8	6,653	6,653	7,038	7,428
TFP-42102-PE	102	42	42	8	-	6,613	7,005	7,404
TFP-48102-PE	102	48	42	8	-	7,241	7,646	8,058
TFP-42108-PE	108	42	42	10	-	6,801	7,193	7,591
TFP-48108-PE	108	48	42	10	-	7,458	7,864	8,276
TFP-42114-PE	114	42	42	10	-	7,356	7,769	8,189
TFP-48114-PE	114	48	42	10	-	8,079	8,506	8,939
TFP-42120-PE	120	42	42	10	-	7,554	7,967	8,386
TFP-48120-PE	120	48	42	10	-	8,308	8,735	9,169
TFP-42132-PE	132	42	42	10	-	8,279	8,710	9,146
TFP-48132-PE	132	48	42	10	-	9,130	9,576	10,027
TFP-42144-PE	144	42	42	12	-	9,039	9,486	9,940
TFP-48144-PE	144	48	42	12	-	9,992	10,455	10,925



# LAMINATE TOP WITH ABS SQUARE EDGE

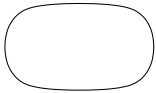

SOFT RECTANGLE TOP

**BASE KEY**

OF Open Frame

RCL Laminate Racetrack Base  
 RCP Painted Racetrack Base  
 RCV Veneer Racetrack Base

**SOFT RECTANGLE TOP TABLES**

MODEL #	LENGTH	WIDTH	HEIGHT	SEATING CAPACITY	-OF	-RCL	-RCP	-RCV
TFV-3060-PE	60	30	42	4	3,556	-	-	-
TFV-3660-PE	60	36	42	4	3,723	-	-	-
TFV-4260-PE	60	42	42	4	4,228	-	-	-
TFV-4860-PE	60	48	42	4	4,562	-	-	-
TFV-3066-PE	66	30	42	4	3,864	-	-	-
TFV-3666-PE	66	36	42	4	4,057	-	-	-
TFV-4266-PE	66	42	42	4	4,622	-	-	-
TFV-4866-PE	66	48	42	4	4,998	-	-	-
TFV-3072-PE	72	30	42	6	3,974	-	-	-
TFV-3672-PE	72	36	42	6	4,185	-	-	-
TFV-4272-PE	72	42	42	6	4,780	4,780	5,110	5,446
TFV-4872-PE	72	48	42	6	5,182	5,182	5,524	5,871
TFV-3078-PE	78	30	42	6	4,368	-	-	-
TFV-3678-PE	78	36	42	6	4,612	-	-	-
TFV-4278-PE	78	42	42	6	5,281	5,281	5,634	5,993
TFV-4878-PE	78	48	42	6	5,738	5,738	6,103	6,474
TFV-3084-PE	84	30	42	8	4,486	-	-	-
TFV-3684-PE	84	36	42	8	4,749	-	-	-
TFV-4284-PE	84	42	42	8	5,450	5,450	5,803	6,161
TFV-4884-PE	84	48	42	8	5,933	5,933	6,299	6,670
TFV-3090-PE	90	30	42	8	4,842	-	-	-
TFV-3690-PE	90	36	42	8	5,139	-	-	-
TFV-4290-PE	90	42	42	8	5,911	5,911	6,282	6,659
TFV-4890-PE	90	48	42	8	6,448	6,448	6,832	7,222
TFV-3096-PE	96	30	42	8	4,966	-	-	-
TFV-3696-PE	96	36	42	8	5,282	-	-	-
TFV-4296-PE	96	42	42	8	6,088	6,088	6,460	6,837
TFV-4896-PE	96	48	42	8	6,653	6,653	7,038	7,428
TFV-42102-PE	102	42	42	8	-	6,613	7,005	7,404
TFV-48102-PE	102	48	42	8	-	7,241	7,646	8,058
TFV-42108-PE	108	42	42	10	-	6,801	7,193	7,591
TFV-48108-PE	108	48	42	10	-	7,458	7,864	8,276
TFV-42114-PE	114	42	42	10	-	7,356	7,769	8,189
TFV-48114-PE	114	48	42	10	-	8,079	8,506	8,939
TFV-42120-PE	120	42	42	10	-	7,554	7,967	8,386
TFV-48120-PE	120	48	42	10	-	8,308	8,735	9,169
TFV-42132-PE	132	42	42	10	-	8,279	8,710	9,146
TFV-48132-PE	132	48	42	10	-	9,130	9,576	10,027
TFV-42144-PE	144	42	42	12	-	9,039	9,486	9,940
TFV-48144-PE	144	48	42	12	-	9,992	10,455	10,925



# LAMINATE TOP WITH ABS SQUARE EDGE

OPTIONS	CODE	PRICE	NOTES
Power & Data Options			See pages 123-133
<b>Polished Chrome Finish Options:</b>			
Polished Chrome Open Frame Base	Add -PCOF-TWE	\$2,612	
<b>Multi-Section Tops:</b>			
102", 108", 114" and 120" one-piece tops split into two sections	Specify -2	\$764	Note: Power Matrix (center of table location only) cannot be specified when this option is selected

## EDGE PROFILE



Two4Six Square Edge

## GENERAL INFORMATION

- Seating capacity based on 27" per person
- Overall table height 42"
- Standard with quarter cut veneer
- One section of wire management channel provided per table
- Racetrack Bases have a removable access door

### REQUIRED INFORMATION (ORDER CANNOT BE ENTERED WITHOUT THIS INFORMATION)

See appendix pages vi-vii for surface material options.

- Choose Laminate Finish
- Choose ABS Edge Finish
- Choose Metal Finish



## GLASS TOP



RECTANGLE TOP

## BASE KEY

OF Open Frame

RCL Laminate Racetrack Base

RCP Painted Racetrack Base

RCV Veneer Racetrack Base

## RECTANGLE TOP TABLES

MODEL #	LENGTH	WIDTH	HEIGHT	SEATING CAPACITY	-OF	-RCL	-RCP	-RCV
TFP-3060-G	60	30	42	4	6,526	-	-	-
TFP-3660-G	60	36	42	4	6,832	-	-	-
TFP-4260-G	60	42	42	4	7,760	-	-	-
TFP-4860-G	60	48	42	4	8,371	-	-	-
TFP-3066-G	66	30	42	4	7,091	-	-	-
TFP-3666-G	66	36	42	4	7,445	-	-	-
TFP-4266-G	66	42	42	4	8,482	-	-	-
TFP-4866-G	66	48	42	4	9,173	-	-	-
TFP-3072-G	72	30	42	6	7,293	-	-	-
TFP-3672-G	72	36	42	6	7,680	-	-	-
TFP-4272-G	72	42	42	6	8,772	8,772	9,378	9,994
TFP-4872-G	72	48	42	6	9,510	9,510	10,137	10,774
TFP-3078-G	78	30	42	6	8,016	-	-	-
TFP-3678-G	78	36	42	6	8,463	-	-	-
TFP-4278-G	78	42	42	6	9,691	9,691	10,340	10,998
TFP-4878-G	78	48	42	6	10,530	10,530	11,200	11,881
TFP-3084-G	84	30	42	8	8,233	-	-	-
TFP-3684-G	84	36	42	8	8,715	-	-	-
TFP-4284-G	84	42	42	8	10,002	10,002	10,649	11,307
TFP-4884-G	84	48	42	8	10,889	10,889	11,560	12,242
TFP-3090-G	90	30	42	8	8,886	-	-	-
TFP-3690-G	90	36	42	8	9,431	-	-	-
TFP-4290-G	90	42	42	8	10,847	10,847	11,529	12,222
TFP-4890-G	90	48	42	8	11,833	11,833	12,538	13,254
TFP-3096-G	96	30	42	8	9,114	-	-	-
TFP-3696-G	96	36	42	8	9,694	-	-	-
TFP-4296-G	96	42	42	8	11,173	11,173	11,855	12,548
TFP-4896-G	96	48	42	8	12,211	12,211	12,916	13,632
TFP-42102-G	102	42	42	8	-	12,137	12,856	13,588
TFP-48102-G	102	48	42	8	-	13,289	14,033	14,789
TFP-42108-G	108	42	42	10	-	12,482	13,201	13,931
TFP-48108-G	108	48	42	10	-	13,688	14,432	15,189
TFP-42114-G	114	42	42	10	-	13,501	14,259	15,028
TFP-48114-G	114	48	42	10	-	14,827	15,610	16,405
TFP-42120-G	120	42	42	10	-	13,863	14,621	15,390
TFP-48120-G	120	48	42	10	-	15,248	16,031	16,827
TFP-42132-G	132	42	42	10	-	15,195	15,984	16,785
TFP-48132-G	132	48	42	10	-	16,756	17,574	18,402
TFP-42144-G	144	42	42	12	-	16,588	17,409	18,242
TFP-48144-G	144	48	42	12	-	18,338	19,187	20,050



## GLASS TOP

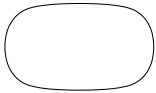

SOFT RECTANGLE TOP

## BASE KEY

OF Open Frame

RCL Laminate Racetrack Base

RCP Painted Racetrack Base

RCV Veneer Racetrack Base

## SOFT RECTANGLE TOP TABLES

MODEL #	LENGTH	WIDTH	HEIGHT	SEATING CAPACITY	-OF	-RCL	-RCP	-RCV
TFV-3060-G	60	30	42	4	6,526	-	-	-
TFV-3660-G	60	36	42	4	6,832	-	-	-
TFV-4260-G	60	42	42	4	7,760	-	-	-
TFV-4860-G	60	48	42	4	8,371	-	-	-
TFV-3066-G	66	30	42	4	7,091	-	-	-
TFV-3666-G	66	36	42	4	7,445	-	-	-
TFV-4266-G	66	42	42	4	8,482	-	-	-
TFV-4866-G	66	48	42	4	9,173	-	-	-
TFV-3072-G	72	30	42	6	7,293	-	-	-
TFV-3672-G	72	36	42	6	7,680	-	-	-
TFV-4272-G	72	42	42	6	8,772	8,772	9,378	9,994
TFV-4872-G	72	48	42	6	9,510	9,510	10,137	10,774
TFV-3078-G	78	30	42	6	8,016	-	-	-
TFV-3678-G	78	36	42	6	8,463	-	-	-
TFV-4278-G	78	42	42	6	9,691	9,691	10,340	10,998
TFV-4878-G	78	48	42	6	10,530	10,530	11,200	11,881
TFV-3084-G	84	30	42	8	8,233	-	-	-
TFV-3684-G	84	36	42	8	8,715	-	-	-
TFV-4284-G	84	42	42	8	10,002	10,002	10,649	11,307
TFV-4884-G	84	48	42	8	10,889	10,889	11,560	12,242
TFV-3090-G	90	30	42	8	8,886	-	-	-
TFV-3690-G	90	36	42	8	9,431	-	-	-
TFV-4290-G	90	42	42	8	10,847	10,847	11,529	12,222
TFV-4890-G	90	48	42	8	11,833	11,833	12,538	13,254
TFV-3096-G	96	30	42	8	9,114	-	-	-
TFV-3696-G	96	36	42	8	9,694	-	-	-
TFV-4296-G	96	42	42	8	11,173	11,173	11,855	12,548
TFV-4896-G	96	48	42	8	12,211	12,211	12,916	13,632
TFV-42102-G	102	42	42	8	-	12,137	12,856	13,588
TFV-48102-G	102	48	42	8	-	13,289	14,033	14,789
TFV-42108-G	108	42	42	10	-	12,482	13,201	13,931
TFV-48108-G	108	48	42	10	-	13,688	14,432	15,189
TFV-42114-G	114	42	42	10	-	13,501	14,259	15,028
TFV-48114-G	114	48	42	10	-	14,827	15,610	16,405
TFV-42120-G	120	42	42	10	-	13,863	14,621	15,390
TFV-48120-G	120	48	42	10	-	15,248	16,031	16,827
TFV-42132-G	132	42	42	10	-	15,195	15,984	16,785
TFV-48132-G	132	48	42	10	-	16,756	17,574	18,402
TFV-42144-G	144	42	42	12	-	16,588	17,409	18,242
TFV-48144-G	144	48	42	12	-	18,338	19,187	20,050



# GLASS TOP

OPTIONS	CODE	PRICE	NOTES
Power & Data Options			See pages 123-133
<b>Polished Chrome Finish Options:</b>			
Polished Chrome Open Frame Base	Add -PCOF-TWE	\$2,612	
<b>Satin Glass Options:</b>			
Satin Glass	Add -TFSG	\$635	
<b>Multi-Section Tops:</b>			
102", 108", 114" and 120" one-piece tops split into two sections	Specify -2	\$764	Note: Power Matrix (center of table location only) cannot be specified when this option is selected

## EDGE PROFILE

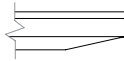

Two4Six Glass Edge

## GENERAL INFORMATION

- Tops are 1-1/8"-thick with 3/16"-thick hardwood edge band
- Seating capacity based on 27" per person
- Overall table height 42"
- Standard with quarter cut veneer
- One section of wire management channel provided per table
- Racetrack Bases have a removable access door

### REQUIRED INFORMATION (ORDER CANNOT BE ENTERED WITHOUT THIS INFORMATION)

See appendix pages vi-vii for surface material options.

- Choose Glass Finish
- Choose Metal Finish
- Choose Sub-Top Finish: Paint Finish or Wood Species & Finish



# SOLID SURFACE TOP



RECTANGLE TOP

**BASE KEY**

OF Open Frame

RCL Laminate Racetrack Base

RCP Painted Racetrack Base

RCV Veneer Racetrack Base

**RECTANGLE TOP TABLES**

MODEL #	LENGTH	WIDTH	HEIGHT	SEATING CAPACITY	-OF	-RCL	-RCP	-RCV
TFP-3060-SS	60	30	42	4	6,819	-	-	-
TFP-3660-SS	60	36	42	4	7,138	-	-	-
TFP-4260-SS	60	42	42	4	8,108	-	-	-
TFP-4860-SS	60	48	42	4	8,747	-	-	-
TFP-3066-SS	66	30	42	4	7,409	-	-	-
TFP-3666-SS	66	36	42	4	7,779	-	-	-
TFP-4266-SS	66	42	42	4	8,863	-	-	-
TFP-4866-SS	66	48	42	4	9,585	-	-	-
TFP-3072-SS	72	30	42	6	7,621	-	-	-
TFP-3672-SS	72	36	42	6	8,025	-	-	-
TFP-4272-SS	72	42	42	6	9,166	9,166	9,798	10,442
TFP-4872-SS	72	48	42	6	9,937	9,937	10,592	11,257
TFP-3078-SS	78	30	42	6	8,375	-	-	-
TFP-3678-SS	78	36	42	6	8,843	-	-	-
TFP-4278-SS	78	42	42	6	10,126	10,126	10,804	11,492
TFP-4878-SS	78	48	42	6	11,003	11,003	11,702	12,415
TFP-3084-SS	84	30	42	8	8,602	-	-	-
TFP-3684-SS	84	36	42	8	9,106	-	-	-
TFP-4284-SS	84	42	42	8	10,450	10,450	11,127	11,815
TFP-4884-SS	84	48	42	8	11,378	11,378	12,079	12,791
TFP-3090-SS	90	30	42	8	9,285	-	-	-
TFP-3690-SS	90	36	42	8	9,854	-	-	-
TFP-4290-SS	90	42	42	8	11,334	11,334	12,046	12,770
TFP-4890-SS	90	48	42	8	12,364	12,364	13,101	13,849
TFP-3096-SS	96	30	42	8	9,523	-	-	-
TFP-3696-SS	96	36	42	8	10,129	-	-	-
TFP-4296-SS	96	42	42	8	11,675	11,675	12,387	13,111
TFP-4896-SS	96	48	42	8	12,759	12,759	13,495	14,243
TFP-42102-SS	102	42	42	8	-	12,682	13,433	14,198
TFP-48102-SS	102	48	42	8	-	13,885	14,662	15,453
TFP-42108-SS	108	42	42	10	-	13,042	13,794	14,556
TFP-48108-SS	108	48	42	10	-	14,302	15,080	15,870
TFP-42114-SS	114	42	42	10	-	14,107	14,899	15,702
TFP-48114-SS	114	48	42	10	-	15,492	16,310	17,142
TFP-42120-SS	120	42	42	10	-	14,485	15,277	16,080
TFP-48120-SS	120	48	42	10	-	15,932	16,750	17,582
TFP-42132-SS	132	42	42	10	-	15,877	16,701	17,538
TFP-48132-SS	132	48	42	10	-	17,508	18,362	19,228
TFP-42144-SS	144	42	42	12	-	17,332	18,190	19,060
TFP-48144-SS	144	48	42	12	-	19,161	20,048	20,949



## SOLID SURFACE TOP

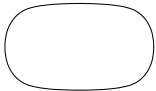

SOFT RECTANGLE TOP

## BASE KEY

OF Open Frame

RCL Laminate Racetrack Base

RCP Painted Racetrack Base

RCV Veneer Racetrack Base

## SOFT RECTANGLE TOP TABLES

MODEL #	LENGTH	WIDTH	HEIGHT	SEATING CAPACITY	-OF	-RCL	-RCP	-RCV
TFV-3060-SS	60	30	42	4	6,819	-	-	-
TFV-3660-SS	60	36	42	4	7,138	-	-	-
TFV-4260-SS	60	42	42	4	8,108	-	-	-
TFV-4860-SS	60	48	42	4	8,747	-	-	-
TFV-3066-SS	66	30	42	4	7,409	-	-	-
TFV-3666-SS	66	36	42	4	7,779	-	-	-
TFV-4266-SS	66	42	42	4	8,863	-	-	-
TFV-4866-SS	66	48	42	4	9,585	-	-	-
TFV-3072-SS	72	30	42	6	7,621	-	-	-
TFV-3672-SS	72	36	42	6	8,025	-	-	-
TFV-4272-SS	72	42	42	6	9,166	9,166	9,798	10,442
TFV-4872-SS	72	48	42	6	9,937	9,937	10,592	11,257
TFV-3078-SS	78	30	42	6	8,375	-	-	-
TFV-3678-SS	78	36	42	6	8,843	-	-	-
TFV-4278-SS	78	42	42	6	10,126	10,126	10,804	11,492
TFV-4878-SS	78	48	42	6	11,003	11,003	11,702	12,415
TFV-3084-SS	84	30	42	8	8,602	-	-	-
TFV-3684-SS	84	36	42	8	9,106	-	-	-
TFV-4284-SS	84	42	42	8	10,450	10,450	11,127	11,815
TFV-4884-SS	84	48	42	8	11,378	11,378	12,079	12,791
TFV-3090-SS	90	30	42	8	9,285	-	-	-
TFV-3690-SS	90	36	42	8	9,854	-	-	-
TFV-4290-SS	90	42	42	8	11,334	11,334	12,046	12,770
TFV-4890-SS	90	48	42	8	12,364	12,364	13,101	13,849
TFV-3096-SS	96	30	42	8	9,523	-	-	-
TFV-3696-SS	96	36	42	8	10,129	-	-	-
TFV-4296-SS	96	42	42	8	11,675	11,675	12,387	13,111
TFV-4896-SS	96	48	42	8	12,759	12,759	13,495	14,243
TFV-42102-SS	102	42	42	8	-	12,682	13,433	14,198
TFV-48102-SS	102	48	42	8	-	13,885	14,662	15,453
TFV-42108-SS	108	42	42	10	-	13,042	13,794	14,556
TFV-48108-SS	108	48	42	10	-	14,302	15,080	15,870
TFV-42114-SS	114	42	42	10	-	14,107	14,899	15,702
TFV-48114-SS	114	48	42	10	-	15,492	16,310	17,142
TFV-42120-SS	120	42	42	10	-	14,485	15,277	16,080
TFV-48120-SS	120	48	42	10	-	15,932	16,750	17,582
TFV-42132-SS	132	42	42	10	-	15,877	16,701	17,538
TFV-48132-SS	132	48	42	10	-	17,508	18,362	19,228
TFV-42144-SS	144	42	42	12	-	17,332	18,190	19,060
TFV-48144-SS	144	48	42	12	-	19,161	20,048	20,949





# SOLID SURFACE TOP

OPTIONS	CODE	PRICE	NOTES
Power & Data Options			See pages 123-133
<b>Polished Chrome Finish Options:</b>			
Polished Chrome Open Frame Base	Add -PCOF-TWE	\$2,612	
<b>Multi-Section Tops:</b>			
102", 108", 114" and 120" one-piece tops split into two sections	Specify -2	\$764	Note: Power Matrix (center of table location only) cannot be specified when this option is selected

## EDGE PROFILE

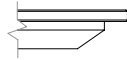

Two4Six Solid Surface Edge

## GENERAL INFORMATION

- Seating capacity based on 27" per person
- Overall table height 42"
- Standard with quarter cut veneer
- One section of wire management channel provided per table
- Racetrack Bases have a removable access door

### REQUIRED INFORMATION (ORDER CANNOT BE ENTERED WITHOUT THIS INFORMATION)

See appendix pages vi-vii for surface material options.

- Choose Solid Surface Finish
- Choose Metal Finish



# VENEER TOP WITH HARDWOOD EDGE



RECTANGLE TOP

**SURFACE MATERIAL KEY**

V Veneer with Hardwood Edge

**STATIONARY TABLES**

MODEL #	LENGTH	WIDTH	HEIGHT	-V
TFD-3672	72	36	29-1/2	8,528
TFD-3684	84	36	29-1/2	9,617
TFD-4284	84	42	29-1/2	11,368

**HEIGHT ADJUSTABLE TABLES**

MODEL #	LENGTH	WIDTH	-V
TFAD-3672	72	36	11,499
TFAD-3684	84	36	12,591
TFAD-4284	84	42	14,339

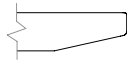
**EDGE PROFILE**

Two4Six Cutback Edge

**GENERAL INFORMATION**

- Features a cutback hardwood edge profile with 5/8" vertical edge
- Adjustable table height range: 28"-42"
- Standard with quarter cut veneer
- Tops are 1-1/8"-thick
- Available with Power Rail only

**REQUIRED INFORMATION (ORDER CANNOT BE ENTERED WITHOUT THIS INFORMATION)**

See appendix pages vi-vii for surface material options.

- Choose Veneer Finish
- Choose Metal Finish

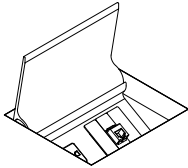

# POWER AND DATA OPTIONS

POWER MATRIX SMALL	MODEL #	DESCRIPTION	W x D	SIMPLEX OUTLETS	BLANK	DATA*	PRICE
	PM-SM-G	Small - Glass Door	6 x 5.375	2	2	1	1,489
	PM-SM-M	Small - Metal Door	6 x 5.375	2	2	1	1,489
	PM-SM-W	Small - Wood Door	6 x 5.375	2	2	1	1,878

\*Each data faceplate includes two RJ-45 (Data) connectors

OPTIONS	CODE	PRICE	NOTES
4 Simplex Receptacles	Add <b>-FOUR</b>	No Charge	Replace AAP's with 2 additional simplex receptacles
3 Simplex Receptacles/Charging USB-A+C	Add <b>-THREE-C</b>	No Charge	Replace AAP's with 1 additional simplex receptacle and 1 charging USB-A+C
USB-A+C Charging	Add <b>-USB-C</b>	\$116 per unit	USB-A+C charger, replaces one of the simplex outlets
Polished Chrome Door	Add <b>-PD</b>	\$223 per unit	Only available with metal door option
Polished Chrome Bezel	Add <b>-PB</b>	\$317 per unit	Only available on glass, stone/quartz and laminate top tables
Field-Wired	Add <b>-FW</b>	Deduct \$43 per unit	May be required in New York City, Chicago and San Francisco. Check with an electrician for local codes and requirements.
Single Infeed Option Available	See page 126		

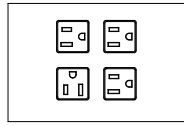

-FOUR

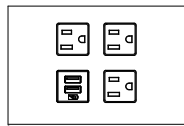

-THREE-C

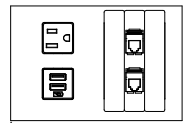

-USB-C

### GENERAL INFORMATION

- Wood species and finish will default to the same as the table top if wood door version is specified
- Glass & wood doors are 1/4" -thick, metal doors are 1/8" -thick
- Glass door is back-painted low-iron glass
- Interior body is clear anodized aluminum
- Each unit includes a 15 amp, 12' power infeed (plug in only)
- If Field-Wired option is specified, each unit includes a 6' flexible metal conduit and requires a hardwire connection
- Standard configuration: Two simplex receptacles, two RJ-45 data connectors and two single blank faceplates
- When specified on tables with laminate, glass or stone/quartz tops, each Power Matrix unit will include a metal bezel and is limited to the glass and metal door options. (-B) will be added to the model number for the bezel.
- Not available on Counter and Standing Height Media Tables
- Additional data/AV faceplate options are on page 126

### REQUIRED INFORMATION: (ORDER CANNOT BE ENTERED WITHOUT THIS INFORMATION)

See appendix pages vi-vii for surface material options.

- Choose location code & quantity from the chart on page 125
- Choose Glass Door Finish, if glass door version is specified
- Choose Metal Finish, if metal door version is specified or for the bezel finish on laminate, glass and stone/quartz tables

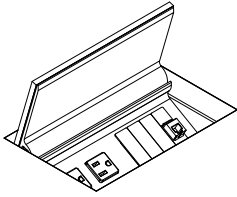

# POWER AND DATA OPTIONS

POWER MATRIX MEDIUM	MODEL #	DESCRIPTION	W x D	SIMPLEX OUTLETS	BLANK	DATA*	PRICE
	PM-MD-G	Medium - Glass Door	6 x 8.25	4	3	1	2,347
	PM-MD-M	Medium - Metal Door	6 x 8.25	4	3	1	2,347
	PM-MD-W	Medium - Wood Door	6 x 8.25	4	3	1	2,739

\*Each data faceplate includes two RJ-45 (Data) connectors

OPTIONS	CODE	PRICE	NOTES
USB-A+C Charging	Add <b>-USB-C</b>	\$116 per unit	USB-A+C charger, replaces one of the simplex outlets
Polished Chrome Door	Add <b>-PD</b>	\$301 per unit	Only available with metal door option
Polished Chrome Bezel	Add <b>-PB</b>	\$354 per unit	Only available on glass, stone/quartz and laminate top tables
Field-Wired	Add <b>-FW</b>	Deduct \$43 per unit	May be required in New York City, Chicago and San Francisco. Check with an electrician for local codes and requirements.
Single Infeed Option Available	See page 126		

## GENERAL INFORMATION

- Wood species and finish will default to the same as the table top if wood door version is specified
- Glass & wood doors are 1/4" -thick, metal doors are 1/8"-thick
- Glass door is back-painted low-iron glass
- Interior body is clear anodized aluminum
- Each unit includes a 15 amp, 12' power infeed (plug in only)
- If Field-Wired option is specified, each unit includes a 6' flexible metal conduit and requires a hardwire connection
- Standard configuration: Two simplex receptacles, two RJ-45 data connectors and two single blank faceplates
- When specified on tables with laminate, glass or stone/quartz tops, each Power Matrix unit will include a metal bezel and is limited to the glass and metal door options. (-B) will be added to the model number for the bezel.
- Not available on Counter and Standing Height Media Tables
- Additional data/AV faceplate options are on page 126

### REQUIRED INFORMATION: (ORDER CANNOT BE ENTERED WITHOUT THIS INFORMATION)

See appendix pages vi-vii for surface material options.

- Choose location code & quantity from the chart on page 125
- Choose Glass Door Finish, if glass door version is specified
- Choose Metal Finish, if metal door version is specified or for the bezel finish on laminate, glass and stone/quartz tables



# POWER AND DATA OPTIONS

LOCATION CODES	POWER MATRIX SMALL	POWER MATRIX MEDIUM	LOCATION	QUANTITY OF UNITS TO ORDER
PS-1	PM-1		One at center	1
PS-1W	PM-1W		One at wall end (Media Table only)	1
PS-2*	PM-2*		One at each end	2
PS-3*	PM-3*		One at center and one at each end	3
PS-4*	PM-4*		Four equally spaced	4

\*Not offered on Media Tables, Standing Height Tables, or Counter Height Tables

## DOOR MATERIAL AND LOCATION AVAILABILITY BY TABLE SIZE

W = Wood Door      G = Glass Door      M = Metal Door

Length	Top Sections	Power Matrix Small					Power Matrix Medium				
		PS-1	PS-1W <sup>†</sup>	PS-2*	PS-3*	PS-4*	PM-1	PM-1W <sup>†</sup>	PM-2*	PM-3*	PM-4*
48	1	W/G/M	-	-	-	-	-	-	-	-	-
54	1	W/G/M	-	-	-	-	-	-	-	-	-
60	1	W/G/M	W/G/M	-	-	-	-	W/G/M	-	-	-
66	1	W/G/M	W/G/M	-	-	-	W/G/M	W/G/M	-	-	-
72	1	W/G/M	W/G/M	-	-	-	W/G/M	W/G/M	-	-	-
84	1	W/G/M	W/G/M	-	-	-	W/G/M	W/G/M	-	-	-
90	1	W/G/M	W/G/M	-	-	-	W/G/M	W/G/M	-	-	-
96	1	W/G/M	W/G/M	-	-	-	W/G/M	W/G/M	-	-	-
102	1	W/G/M	-	W/G/M	W/G/M	-	W/G/M	-	W/G/M	W/G/M	-
102	2	-	-	W/G/M	-	-	-	-	W/G/M	-	-
108	1	W/G/M	-	W/G/M	W/G/M	-	W/G/M	-	W/G/M	W/G/M	-
108	2	-	-	W/G/M	-	-	-	-	W/G/M	-	-
114	1	W/G/M	-	W/G/M	W/G/M	-	W/G/M	-	W/G/M	W/G/M	-
114	2	-	-	W/G/M	-	-	-	-	W/G/M	-	-
120	1	W/G/M	-	W/G/M	W/G/M	-	W/G/M	-	W/G/M	W/G/M	-
120	2	-	-	W/G/M	-	-	-	-	W/G/M	-	-
132	2	-	-	W/G/M	-	W/G/M	-	-	W/G/M	-	W/G/M
144	2	-	-	W/G/M	-	W/G/M	-	-	W/G/M	-	W/G/M
156	2	-	-	W/G/M	-	W/G/M	-	-	W/G/M	-	W/G/M
168	2	-	-	W/G/M	-	W/G/M	-	-	W/G/M	-	W/G/M
180	2	-	-	W/G/M	-	W/G/M	-	-	W/G/M	-	W/G/M
192	2	-	-	W/G/M	-	W/G/M	-	-	W/G/M	-	W/G/M
192	4	-	-	W/G/M	-	W/G/M	-	-	W/G/M	-	W/G/M
204	2	-	-	W/G/M	-	W/G/M	-	-	W/G/M	-	W/G/M
204	4	-	-	W/G/M	-	W/G/M	-	-	W/G/M	-	W/G/M
216	2	-	-	W/G/M	-	W/G/M	-	-	W/G/M	-	W/G/M
216	4	-	-	W/G/M	-	W/G/M	-	-	W/G/M	-	W/G/M
228	2	-	-	W/G/M	-	W/G/M	-	-	W/G/M	-	W/G/M
228	4	-	-	W/G/M	-	W/G/M	-	-	W/G/M	-	W/G/M
240	2	-	-	W/G/M	-	W/G/M	-	-	W/G/M	-	W/G/M
240	4	-	-	W/G/M	-	W/G/M	-	-	W/G/M	-	W/G/M

<sup>†</sup> Available on Media Tables only

\*Not offered on Media Tables, Standing Height Tables, or Counter Height Tables



# POWER AND DATA OPTIONS

SINGLE INFEED OPTION	MODEL #	DESCRIPTION	PRICE
	SI-H	Single In-Feed Option, Hard-wired	553
	SI-C	Single In-Feed Option, Corded (Plug-in)	668

## GENERAL INFORMATION

- Tables 72" -120" in length include 2 duplex receptacles with the modular power system
- Tables 132" -240" in length include 3 duplex receptacles with the modular power system
- Hardwired and Corded Single In-Feed options are 7' long
- Single In-Feed option cannot be specified in conjunction with the Field-Wired (-FW) option
- Corded Single In-Feed option will require a 20-amp power outlet in the floor monument and reduces the modular electrical system in the table to a single circuit

RETRACTORS	MODEL #	DESCRIPTION	PRICE
	CR-CAT6	CAT6 Retractor	907
	CR-HDMI	HDMI Retractor	907
	CR-DISPLAY	Display Port Retractor	907
	CR-USB	Data USB Retractor	907

CR-HDMI

## GENERAL INFORMATION

- Mounting bracket and attaching hardware included with each retractor
- Can only be used with Power Matrix Small or Medium units
- Not available on square, round or soft square tables
- One Cable Pass Through Set (one top, one bottom) AAP FLDF-14 included. Double style AAP
- See page 20 for availability by table size

DATA FACEPLATES	MODEL #	DESCRIPTION	STYLE	W x H	PRICE
	FLDF-1	Blank faceplate, single height	Single	3-1/2 x 5/8	74
	FLDF-2	One VGA 15-pin HD Female to Female Gender Changer, one 3.5mm Stereo Mini Jack to Solder Tabs	Single	3-1/2 x 5/8	259
	FLDF-3	One VGA 15-pin HD Female to Female Gender Changer	Single	3-1/2 x 5/8	203
	FLDF-4	One RJ-11 Female to Punch Down - Phone	Single	3-1/2 x 5/8	203
	FLDF-5	One RJ-45 Female to Female Barrel - Data	Single	3-1/2 x 5/8	166
	FLDF-6	Two RJ-45 Female to Female Barrels, single height	Single	3-1/2 x 5/8	223
	FLDF-7	Two RJ-45 Female to Punch Down for CAT 6 - AMP	Single	3-1/2 x 5/8	315
	FLDF-8	Two RJ-45 Female to Punch Down for CAT 6 - Leviton	Single	3-1/2 x 5/8	315
	FLDF-10	Two RJ-45 Female to Punch Down for CAT 6 - Panduit	Single	3-1/2 x 5/8	315
	FLDF-11	Two USB A Female to Two USB A Female on 10" Pigtailed	Single	3-1/2 x 5/8	352
	FLDF-12	Blank faceplate, double height	Double	3-1/2 x 1-3/8	92
	FLDF-13	Two RJ-45 Female to Female Barrels, double height	Double	3-1/2 x 1-3/8	223
	FLDF-14	Cable Pass-Through Set - one top, one bottom	Double	3-1/2 x 1-3/8	389
	FLDF-15	One HDMI Female to Female Barrel	Single	3-1/2 x 5/8	259

## GENERAL INFORMATION

- All connectors and faceplates are Extron® Architectural Adapter Plates (AAP)
- Each TW-RAIL-DATA unit holds two Single Space faceplates
- Faceplates are black



# POWER AND DATA OPTIONS

FOUR PORT POWER CAP	MODEL #	SHAPE	DESCRIPTION	L x W	SIMPLEX OUTLETS	DUAL USB-A+C	DATA	ONE AT CENTER OR END	ONE AT EACH END	EQUALLY SPACED STARTING AT 96"	EQUALLY SPACED STARTING AT 132"
								-1	-2	-3	-4
<p>CAP-SUUS</p> <p>CAP-SUAA</p> <p>CAP-SSAA</p>	CAP-SUUS-B-C	Racetrack	Black Simplex	9 x 2	2	2	-	1,557	3,114	4,671	6,228
	CAP-SUUS-W-C	Racetrack	White Simplex	9 x 2	2	2	-	1,557	3,114	4,671	6,228
	CAP-SUAA-B-C	Racetrack	Black Simplex/AAP	9 x 2	1	1	2	1,293	2,586	3,879	5,172
	CAP-SUAA-W-C	Racetrack	White Simplex/Black AAP	9 x 2	1	1	2	1,293	2,586	3,879	5,172
	CAP-SSAA-B	Racetrack	Black Simplex/AAP	9 x 2	2	-	2	1,134	2,268	3,402	4,536
	CAP-SSAA-W	Racetrack	White Simplex/Black AAP	9 x 2	2	-	2	1,134	2,268	3,402	4,536

OPTIONS	CODE	PRICE	NOTES
Polished Chrome Plate	Add <b>-PCP</b>	\$70 per unit	
Field-Wired	Add <b>-FW</b>	Add \$97 per unit	May be required in New York City, Chicago and San Francisco. Check with an electrician for local codes and requirements.

### GENERAL INFORMATION

- Data includes two single space Extron Architectural Adapter Plates (AAP's)
- Reference location chart

### REQUIRED INFORMATION: (ORDER CANNOT BE ENTERED WITHOUT THIS INFORMATION)

- See appendix pages vi-vii for surface material options.
- Choose Metal Finish (unless Polished Chrome has been specified)

TWO PORT POWER CAP	MODEL #	SHAPE	DESCRIPTION	L x W	SIMPLEX OUTLETS	DUAL USB-A+C	DATA	ONE AT CENTER OR END	ONE AT EACH END	EQUALLY SPACED STARTING AT 96"	EQUALLY SPACED STARTING AT 132"
								-1	-2	-3	-4
<p>CAP-SU</p> <p>CAP-SS</p>	CAP-SU-B-C	Racetrack	Black Simplex	5.5 x 2	1	1	-	1,137	2,274	3,411	4,548
	CAP-SU-W-C	Racetrack	White Simplex	5.5 x 2	1	1	-	1,137	2,274	3,411	4,548
	CAP-SS-B	Racetrack	Black Simplex	5.5 x 2	2	-	-	976	1,952	2,928	3,904
	CAP-SS-W	Racetrack	White Simplex	5.5 x 2	2	-	-	976	1,952	2,928	3,904

OPTIONS	CODE	PRICE	NOTES
Polished Chrome Plate	Add <b>-PCP</b>	\$70 per unit	
Field-Wired	Add <b>-FW</b>	Add \$97 per unit	May be required in New York City, Chicago and San Francisco. Check with an electrician for local codes and requirements.

### GENERAL INFORMATION

- Data includes two single space Extron Architectural Adapter Plates (AAP's).
- Reference location chart

### REQUIRED INFORMATION: (ORDER CANNOT BE ENTERED WITHOUT THIS INFORMATION)

- See appendix pages vi-vii for surface material options.
- Choose Metal Finish (unless Polished Chrome has been specified)

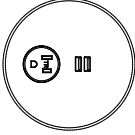

# POWER AND DATA OPTIONS

TWO PORT SOFT SQUARE, ROUND OR SQUARE POWER CAP		MODEL #	SHAPE	DESCRIPTION	L x W	SIMPLEX OUTLETS	DUAL USB-A+C	PRICE
	CAPS-SU-B-C	Soft Square	Black Simplex	5x5	1	1	1,137	
	CAPS-SU-W-C	Soft Square	White Simplex	5x5	1	1	1,137	
	CAPR-SU-B-C	Round	Black Simplex	5x5	1	1	1,137	
	CAPR-SU-W-C	Round	White Simplex	5x5	1	1	1,137	
	CAPQ-SU-B-C	Square	Black Simplex	5x5	1	1	1,137	
	CAPQ-SU-W-C	Square	White Simplex	5x5	1	1	1,137	
	CAPS-SS-B-	Soft Square	Black Simplex	5x5	2	-	976	
	CAPS-SS-W-	Soft Square	White Simplex	5x5	2	-	976	
	CAPR-SS-B-	Round	Black Simplex	5x5	2	-	976	
	CAPR-SS-W-	Round	White Simplex	5x5	2	-	976	
	CAPQ-SS-B-	Square	Black Simplex	5x5	2	-	976	
	CAPQ-SS-W-	Square	White Simplex	5x5	2	-	976	

OPTIONS	CODE	PRICE	NOTES
Polished Chrome Plate	Add <b>-PCP</b>	\$70 per unit	
Field-Wired	Add <b>-FW</b>	Add \$97 per unit	May be required in New York City, Chicago and San Francisco. Check with an electrician for local codes and requirements.

### GENERAL INFORMATION

- Available on Radius Square & Round Tops only
- Available at center location only

### REQUIRED INFORMATION: (ORDER CANNOT BE ENTERED WITHOUT THIS INFORMATION)

- See appendix pages vi-vii for surface material options.
- Choose Metal Finish (unless Polished Chrome has been specified)

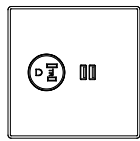

CAPQ-SU

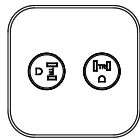

CAPS-SS

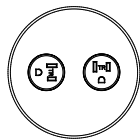

CAPR-SS

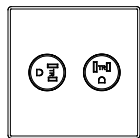

CAPQ-SS

LOCATION CODES	POWER CAP	DESCRIPTION	LOCATION	QUANTITY OF UNITS TO ORDER
CP4-1	Power Cap 4 Port Racetrack Shape	One at Center	1	
CP4-1W	Power Cap 4 Port Racetrack Shape (Media Table)	One at End (Media Table Only)	1	
CP4-2	Power Cap 4 Port Racetrack Shape	One at Each End	2	
CP4-3	Power Cap 4 Port Racetrack Shape	3 Equally Spaced (starting at 96")	3	
CP4-4	Power Cap 4 Port Racetrack Shape	4 Equally Spaced (starting at 132")	4	
CP2-1	Power Cap 2 Port Racetrack Shape	One at Center	1	
CP2-1W	Power Cap 2 Port Racetrack Shape (Media Table)	One at End (Media Table Only)	1	
CP2-2	Power Cap 2 Port Racetrack Shape	One at Each End	2	
CP2-3	Power Cap 2 Port Racetrack Shape	3 Equally Spaced (starting at 96")	3	
CP2-4	Power Cap 2 Port Racetrack Shape	4 Equally Spaced (starting at 132")	4	
CPS2-1	Power Cap 2 Port Soft Square Shape (Soft Square Tables only)	One at Center	1	
CPR2-1	Power Cap 2 Port Round Shape (Round Tables Only)	One at Center	1	
CPQ2-1	Power Cap 2 Port Square Shape (Square Tables Only)	One at Center	1	



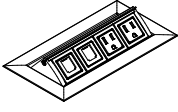

# POWER AND DATA OPTIONS

TECH NODE	MODEL #	W X D	SIMPLEX RECEPTACLES	OPEN DATA PORTS	CHARGING USB-A+C	PRICE
 PUP	PUP	8 x 4	2	2	-	543
	PUP-USB-AC	8 x 4	2	1	1	647



OPTIONS	CODE	PRICE	NOTES
Field-Wired	Add <b>-FW</b>	No Charge	May be required in New York City, Chicago and San Francisco. Check with an electrician for local codes and requirements.

### GENERAL INFORMATION

- PUP option includes two simplex receptacles and two voice/data openings
- PUP-USB-AC option includes two simplex receptacles, one USB-A+C charger and one voice/data opening
- 12' cord and a 15 amp plug-in power Infeed
- Voice/data modules must be ordered separately; contact your local AV integrator
- Default color to metal finish specified on tables (Shadow, Storm, Black, Aged Bronze, Satin Bronze and Galaxy receive Black Anodized Tech Node; Cloud, Burnished and Foil receive Clear Anodized Tech Node)
- UL Listed
- Includes a Voice/Data Adapter Kit to accept couplers and jacks when required

### REQUIRED INFORMATION: (ORDER CANNOT BE ENTERED WITHOUT THIS INFORMATION)

- See appendix pages vi-vii for surface material options.
- Choose location code and quantity from chart on page 130



POWER SPEC	MODEL #	DESCRIPTION	PRICE
 PWR-R-B	PWR-R-B	Round Power Spec with Black Faceplate	116
	PWR-R-W	Round Power Spec with White Faceplate	116
 PWR-SQ-B	PWR-SQ-B	Square Power Spec with Black Faceplate	116
	PWR-SQ-W	Square Power Spec with White Faceplate	116

### GENERAL INFORMATION

- Includes one simplex receptable
- 12' cord

### REQUIRED INFORMATION: (ORDER CANNOT BE ENTERED WITHOUT THIS INFORMATION)

- See appendix pages vi-vii for surface material options.
- Choose Metal Finish: Satin Nickel (SNB) or Chrome (CB)

USB SPEC	MODEL #	DESCRIPTION	PRICE
 USBC-R-B	USBC-R-B	Round Data Spec with Black Faceplate	243
	USBC-R-W	Round Data Spec with White Faceplate	243
 USBC-SQ-B	USBC-SQ-B	Square Data Spec with Black Faceplate	243
	USBC-SQ-W	Square Data Spec with White Faceplate	243

### GENERAL INFORMATION

- Includes one charging USB-A+C
- 6' cord

### REQUIRED INFORMATION: (ORDER CANNOT BE ENTERED WITHOUT THIS INFORMATION)

- See appendix pages vi-vii for surface material options.
- Choose Metal Finish: Satin Nickel (SNB) or Chrome (CB)



# POWER AND DATA OPTIONS

GROMMET	MODEL #	DESCRIPTION	DIAMETER	PRICE
	GR	Round Grommet	2" Dia	220



OPTIONS	CODE	PRICE	NOTES
Polished Chrome Grommet	Add -PCG	\$86 per unit	

**GENERAL INFORMATION**

- Available at center location only

**REQUIRED INFORMATION: (ORDER CANNOT BE ENTERED WITHOUT THIS INFORMATION)**

- See appendix pages vi-vii for surface material options.
- Choose Metal Finish: Powder Coat, Clear Anodized or Polished Chrome (upcharge applies)

POWER POLE	MODEL #	DESCRIPTION	PRICE
	TF-PP	Power Pole	924

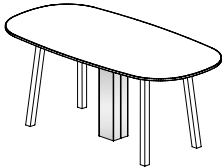

**REQUIRED INFORMATION: (ORDER CANNOT BE ENTERED WITHOUT THIS INFORMATION)**

- See appendix pages vi-vii for surface material options.
- Choose Metal Finish (Clear Anodized -CA not available)

LOCATION CODES	TECH NODE	POWER SPEC	USB SPEC	ROUND GROMMET	LOCATION	QUANTITY OF UNITS TO ORDER
	TN-1	SP-1	SP-1	G-1	One at center	1
	TN-1W	SP-1W	SP-1W	G-1W	One at wall end	1
	TN-2*	SP-2	SP-2		One at each end	2
	TN-3*	SP-3	SP-3		One at center and one at each end	3
	TN-4*	SP-4	SP-4		Four equally spaced	4

\*TN-2, TN-3 and TN-4 not offered on Media Tables, Standing Height Tables, or Counter Height Tables



# POWER AND DATA OPTIONS

HARDWIRE INFEED POWER RAIL KIT	MODEL #	TOTAL # OF RAILS	ELECTRICAL OUTLETS	(2) SIMPLEX -S2	ELECTRICAL OUTLETS	(1) SIMPLEX / (1) CHARGING USB -S3
(Includes Power Rails, Hardwire Infeed and Modular Power Components)	TF-RAIL-1-H	1	2	1,331	1	1,331
	TF-RAIL-2-H	2	4	2,114	2	2,114
	TF-RAIL-3-H	3	6	2,895	3	2,895
	TF-RAIL-4-H	4	8	3,677	4	3,677
	TF-RAIL-5-H	5	10	4,459	5	4,459
	TF-RAIL-6-H	6	12	5,239	6	5,239
	TF-RAIL-7-H	7	14	6,019	7	6,019
	TF-RAIL-8-H	8	16	6,800	8	6,800

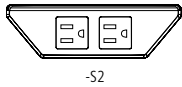

-S2

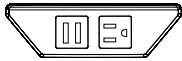

-S3

### GENERAL INFORMATION

- Includes modular power electrical system
- Hardwire infeed is 7' long
- Simplex receptacles will be white, when Burnished, Cloud or Foil powdercoat finishes are specified. Black simplex receptacles will be used for all other powdercoat finishes.
- Power Rails not available in Clear or Black Anodized

**REQUIRED INFORMATION: (ORDER CANNOT BE ENTERED WITHOUT THIS INFORMATION)**

See appendix pages vi-vii for surface material options.

- Choose Metal Finish

CORDED INFEED POWER RAIL KIT	MODEL #	TOTAL # OF RAILS	ELECTRICAL OUTLETS	(2) SIMPLEX -S2	ELECTRICAL OUTLETS	(1) SIMPLEX / (1) CHARGING USB -S3
(Includes Power Rails, Corded Infeed and Modular Power Components)	TF-RAIL-1-C	1	2	1,448	1	1,448
	TF-RAIL-2-C	2	4	2,232	2	2,232
	TF-RAIL-3-C	3	6	3,012	3	3,012
	TF-RAIL-4-C	4	8	3,792	4	3,792
	TF-RAIL-5-C	5	10	4,573	5	4,573
	TF-RAIL-6-C	6	12	5,357	6	5,357
	TF-RAIL-7-C	7	14	6,138	7	6,138
	TF-RAIL-8-C	8	16	6,918	8	6,918

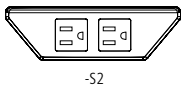

-S2

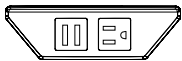

-S3

### GENERAL INFORMATION

- Includes modular power electrical system
- Corded single infeed is 7' long
- Corded Single Infeed option will require a 20amp outlet in the floor monument and reduces the modular electrical system in the table to a single circuit
- Simplex receptacles will be white, when Burnished, Cloud or Foil powdercoat finishes are specified. Black simplex receptacles will be used for all other powdercoat finishes.
- Power Rails not available in Clear or Black Anodized

**REQUIRED INFORMATION: (ORDER CANNOT BE ENTERED WITHOUT THIS INFORMATION)**

See appendix pages vi-vii for surface material options.

- Choose Metal Finish

DATA RAIL	MODEL #	DESCRIPTION	PRICE
	TF-RAIL-DATA	Data Rail includes (1) blank faceplate and (1) dual RJ-45 faceplate	604



FW-RAIL-DATA

### GENERAL INFORMATION

- Data Rails not available in Clear or Black Anodized

**REQUIRED INFORMATION: (ORDER CANNOT BE ENTERED WITHOUT THIS INFORMATION)**

See appendix pages vi-vii for surface material options.

- Choose Metal Finish



# POWER AND DATA OPTIONS

FIELD-WIRED	MODEL #	DESCRIPTION	(2) SIMPLEX -S2	(1) SIMPLEX / (1) CHARGING USB -S3
	TF-RAIL-FW	Field-Wired Power Rail	696	696

**GENERAL INFORMATION**

- Includes 6' flexible metal conduit and required a hardwire connection
- May be required in New York City, Chicago and San Francisco. Check with an electrician for local codes and requirements. A junction box will be provided when ordering the TW-RAIL-FW option.
- Power Rails not available in Clear or Black Anodized

**REQUIRED INFORMATION: (ORDER CANNOT BE ENTERED WITHOUT THIS INFORMATION)**

- See appendix pages vi-vii for surface material options.
- Choose Metal Finish

INDIVIDUAL POWER RAIL	MODEL #	DESCRIPTION	(2) SIMPLEX -S2	(1) SIMPLEX / (1) CHARGING USB -S3
	TF-RAIL	Power Rail	784	784

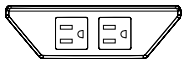

-S2



-S3

**GENERAL INFORMATION**

- Individual power rails do not include a modular power system. Each Power Rail must directly plug into a floor core with a 6'-corded 15-amp plug-in infeed. (Typically used with smaller tables, rounds, squares, soft squares, where a modular power system is not required.)
- Simplex receptacles will be white, when Burnished, Cloud or Foil powdercoat finishes are specified. Black simplex receptacles will be used for all other powdercoat finishes.
- Power Rails not available in Clear or Black Anodized

**REQUIRED INFORMATION: (ORDER CANNOT BE ENTERED WITHOUT THIS INFORMATION)**

- See appendix pages vi-vii for surface material options.
- Choose Metal Finish

CHARGING TRAC	MODEL #	TOTAL BRACKETS	# OF USB PORTS	PRICE
	TRAC-2	2	4	2,019
	TRAC-4	4	8	3,406



**GENERAL INFORMATION**

- Plug-in Infeed only
- Field Installed
- 15 amp

**REQUIRED INFORMATION: (ORDER CANNOT BE ENTERED WITHOUT THIS INFORMATION)**

- See appendix pages vi-vii for surface material options.
- Choose Metal Finish



# FREESTANDING POWER OPTION

TECH ZONE	MODEL #	DESCRIPTION	SIMPLEX OUTLETS	OPEN DATA PORTS	CHARGING USB-A+C	PRICE
	ZONE-DATA	(2) Simplex receptacles, (2) Open data ports	2	2	-	341
	ZONE-USB-C	(2) Simplex receptacles, (1) Charging USB-A+C, (1) Open data port	2	1	1	408

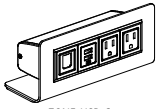

ZONE-USB-C



ZONE-DATA



ZONE-USB-C

## GENERAL INFORMATION

- 72" long plug-in infeed cord
- Finish is black
- Includes a Voice/Data Adapter Kit to accept couplers and jacks when required



# ACCESSORIES

CADDY	MODEL #	W x D	DESCRIPTION	PAINTED -PS	VENEER -V
	TFCA-1820	18 x 20	Caddy	1,509	2,285

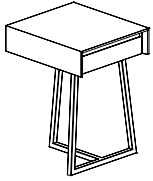

OPTIONS	CODE	PRICE	NOTES
Polished Chrome Grommet Finish on Base	Add <b>-PCBF</b>	\$1,050	

**GENERAL INFORMATION**

- Box height 5.125"
- Total height 26"
- Drawer has integrated pull
- Standard with quarter cut veneer
- White painted drawer box with undermount self soft close slides

**REQUIRED INFORMATION: (ORDER CANNOT BE ENTERED WITHOUT THIS INFORMATION)**

See appendix pages vi-vii for surface material options.

- Choose Veneer Finish, if applicable
- Choose Paint Finish, if applicable
- Choose Metal Finish (Clear Anodized (-CA) metal finish not available)

VIDEO CONFERENCE CAMERA SHELF	MODEL #	W x D	PRICE
	NEVC-1407	14 x 7	441



**GENERAL INFORMATION**

- Shelf is 1/4" thick Foil powder coated aluminum and can be positioned at any height
- Field installed
- Camera shelf is not available on Freestanding and Height Adjustable Media Tables



# VENEER TOP WITH HARDWOOD EDGE

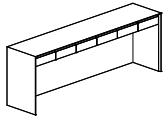

CONSOLE  
TFDC-8430

## SURFACE MATERIAL KEY

V Veneer

## CONSOLE

MODEL #	WIDTH	LENGTH	HEIGHT	# OF DRAWERS	-V
TFDC-5626	56	19	26	4 Drawers	3,393
TFDC-7026	70	19	26	5 Drawers	3,836
TFDC-8426	84	19	26	6 Drawers	4,279
TFDC-5630	56	19	30	4 Drawers	3,902
TFDC-7030	70	19	30	5 Drawers	4,412
TFDC-8430	84	19	30	6 Drawers	4,921

## GENERAL INFORMATION

- White drawer boxes with under-mount self soft-closing slides
- Overall drawer dimensions are 15" x 12.5" x 3.25". Interior drawer box dimensions are 14" x 11.5" x 2.5".
- Standard with quarter cut veneer

### REQUIRED INFORMATION (ORDER CANNOT BE ENTERED WITHOUT THIS INFORMATION)

See appendix pages vi-vii for surface material options.

- Choose Veneer Finish



# Appendix

---





# GENERAL INFORMATION

This price book supercedes all previous versions.

**Before placing your order, confirm you have all required information necessary. Lead times for orders begin after all required information is included and correct.**

## Delivery Information

We know lead times are important and sticking to them even more so. We work to maintain a 6-8 week lead time on all standard products in this book from receipt of a clean order. All orders are acknowledged with an approximate shipping date and will be invoiced with the price in effect at the date the purchase order is received.

Shipping charges are prepaid (within the continental U.S.). Therefore, pricing is a delivered price based on normal ground transportation. If you have special instructions, need to ship by air, or are shipping to Alaska or Hawaii, contact Nucraft Customer Service. Nucraft can also help arrange to have products blanket wrapped for an additional charge. Contact the Nucraft Customer Service team or specify it on your purchase order.

**Minimum Freight Charge: Any order below \$2,800 net will be assessed a \$450 net minimum freight charge (one per order).**

Orders are subject to acquiring the materials required for manufacturing. Fulfillment can be affected by strikes, fires, embargoes and acts of government. These elements are beyond our control.

Nucraft offers a variety of services to accommodate a wide range of delivery requirements. Availability of these services is dependent on a number of factors and may not be offered with all shipments. Examples of delivery services that have additional fees include:

- Specific date within our standard 3-5 day delivery window (for orders under \$50,000 net)
- Specific time of day, morning or afternoon (for orders under \$50,000 net)
- Delivery to a warehouse before delivery to its final destination (unless product is picked up at the warehouse)

Contact the Nucraft Customer Service team for availability and pricing on these services.

## Freight Terms

Shipping charges for Nucraft products are prepaid for standard delivery in the continental United States. Standard delivery is defined as follows: Product is delivered on a 53' trailer being pulled by a long-haul tractor (total length of 85'). Facility will receive delivery Monday through Friday between the hours of 8:00 AM and 4:00 PM. Facility has docks with levelers and a fork truck for unloading. Product will be loaded on load bars two levels high. Receiving facility is responsible to have personnel on hand to unload the truck upon arrival, drivers do not unload. Delivery sites or times that do not meet this criteria will be accommodated, but will typically incur a charge to cover additional shipping costs. Please notify Nucraft in advance of the shipment if this is the case and the additional charge (if any) will be determined by Nucraft.

Product ships FOB dock. The customer obtains title to their product and materials, and assumes the risk of loss for them, upon shipment from Nucraft's facilities.

## Storage

Nucraft has no storage facilities for finished product. If a customer cannot accept an order when it is ready for shipment, the customer must designate an alternative shipping address. If no address is provided, Nucraft may, at its discretion, transfer the product to storage. If product is transferred to an off-site storage facility, the customer may be charged for transportation to the facility and for any associated storage fees. Nucraft considers transfer of the product to a storage facility the equivalent of shipment, including invoicing and payment. Customers assume the risk of damage or loss during storage.

## Transportation Times and Delays

Third party carriers that Nucraft contracts with will make reasonable efforts to accommodate requested delivery times and dates. Scheduled delivery appointments may, however, be delayed for a variety of reasons, including inclement weather, traffic, transportation equipment problems, and delays encountered at other delivery locations along the delivery route. Nucraft does not recommend scheduling activities that depend on the delivery appointment (for example, scheduling furniture installers to install furniture the day of the delivery appointment). Nucraft shall not be liable for any costs incurred as a result of a missed delivery appointment.

## Shipment Damage Claims

Legal title to merchandise passes to the buyer upon acceptance by the carrier. **Inspect all cartons upon delivery.** Details of visible damage should be noted on the delivery receipt. Do not install product if damage is found upon inspection. The carrier should be notified by the buyer to inspect the merchandise, and file a claim immediately. If visible damage is not apparent, sign the delivery receipt "No visible damage." This will allow recourse for a concealed damage claim. Although most claims for transportation damages must be filed against the carrier within nine months of the date of delivery, concealed damage claims must be filed within 15 days of receipt.

Do not destroy packing materials until shipment has been inspected. Then proceed to file a claim with the carrier.

**Failure to make any claims against Nucraft within 10 days shall constitute acceptance of the merchandise and a waiver of any defects, errors or shortages discovered upon inspection.**

## Cancellations

Cancellations must be reviewed by our Customer Service team. Because we build your products to order, orders cannot be cancelled once processing has begun. Processing includes but is not limited to development of shop drawings and other engineering drawings. If cancellation is approved, a processing fee of 20-100% will be assessed based on the status of the order.

## Change Order Policy

Nucraft will make every attempt to honor any reasonable change request to product provided that the request is received prior to start of production. Change orders will be accepted only if the request is made in writing and received in time to make the change. Nucraft reserves the right to increase our acknowledged price and ship date if necessary to make the requested changes. Please submit any change order request to our Customer Service team. Nucraft will assess charges to the customer as stipulated in the following:

- Standard Orders: Change orders received prior to production will be charged \$400 net to cover administrative costs.
- Special Orders: Change orders received prior to production will be charged \$400 net to cover administrative costs. There may be additional costs associated with engineering labor required for the change order.
- Change orders received after production must be evaluated by Nucraft. If approved, the charge will be \$400 net plus any restocking charges accumulated. There may be additional costs associated with engineering and/or manufacturing labor, as well as material costs, required for the change order.



# GENERAL INFORMATION

## Repair Authorization

Prior written approval is required for repairs of merchandise charged to Nucraft. Failure to do so will result in customer funded repairs.

## Payment Terms

Deposits are required at the time of order due to the custom nature of our products. See information regarding Cancellations above.

Credit terms are available to qualified customers. Please contact AR@Nucraft.com to start the application process. Note that the credit application process requires a valid sales tax exemption or resale tax certificate, Form W-9, and three current trade references.

Credit Card Payments are accepted via web portal. Please contact AR@Nucraft.com for payment instructions. Note that a 2% convenience fee will be added for using this payment method and no early pay discounts are allowed on credit card payments.

## Warranty

Nucraft Furniture is warranted to be free from defects in materials and workmanship for a period of ten years of single shift use. Limitations include:

- Mechanical Devices such as latches, casters, and other moving components are warranted for five years of the date of original delivery.
- Height adjustable components are warranted for two years of the date of original delivery.
- The following are warranted for one year of the date of original delivery:
  - Textiles
  - Electrical Components
  - Refrigeration Units
  - Custom Products not described in Nucraft's Catalogue

This warranty is applicable only if furniture is properly installed and maintained in an office environment. This warranty extends only to products manufactured and sold in North America and only to original purchasers acquiring new Nucraft product through authorized dealers or approved sellers.

During this warranty period, Nucraft's sole obligation is to repair or replace, at Nucraft's discretion, products which prove to be defective during the warranty period.

This warranty does not cover:

- Damage caused by a carrier.
- Damage from user modification, misuse, abuse, accident, or negligence.
- Customer's Own Material (COM) specified by the customer that is not a standard product offering.
- Color, grain, or texture of wood and other covering material.

**Nucraft extends no other warranties, expressed or implied, including warranty of merchantability or fitness for a particular purpose. Nucraft shall not be liable for loss of time, inconvenience, commercial loss, incidental or consequential damages.**

## Environmental Statement

Nucraft is committed to supporting responsible environmental policies and practices in all that we do. We strive for sustainability, weighing our business decisions against the costs to the ecological, social and economic systems they affect.

Our products are manufactured to meet the credit requirements of the U.S. Green Building Council's LEED rating systems in one or more of the following categories:

- Recycled Content
- Certified Wood
- Low-Emitting Materials

## Computer Aided Planning

Nucraft products and pricing are available on CD via 2020 Cap, an AutoCAD®-based space planning tool.

2020 Cap is an integrated software system developed specifically for interior designers and facility planners to enhance workplace performance. This modern suite of applications works together seamlessly, in concert. Navigate catalogs, select products, design in plan view and 3D, assign options, create worksheets and build a project where you want, when you want. Take your pick. It's dynamic and interactive. Design projects are a work in progress. And now you can perform any of the many discrete tasks that go into a project any time, any place.

For additional information, you may contact 2020 Cap direct at 800-227-0038.

## iSpec®

Nucraft offers a free online product configuration and specification service that saves you time and allows you to be creative while leaving the nuts and bolts to someone else. No specific software is required, nor is there any learning curve. This service applies to all Nucraft products. For additional information, call 1-877-NUCRAFT and ask for the iSpec Team or log on to [www.nucraft.com/ispec](http://www.nucraft.com/ispec).



# FINISH INFORMATION

## Surface Materials Palette

We crafted our materials palette using the same demanding standards that distinguish our furniture. Thoughtful design and attention to every detail elevate your possibilities.

Anchored by NuCraft veneers, unrivaled for clarity, quality, and depth of finish, our collection of surface materials comprises a sophisticated set of balanced elements that supports your design vision.

Some elements have their roots in NuCraft’s rich heritage. Others are new materials and reflect current trends and taste. Together, they ensure that you’re ready for today and positioned well for the future. Beautifully.

## Custom Finishes

NuCraft specializes in expert custom finish matching. For a nominal upcharge we can provide custom finishes, and we are frequently asked to match the finishes of other furniture manufacturers. For finishes that appear unusual to match or for customers directly requesting a sample, a finish sample will be sent for approval prior to entering the order.

Custom finishes requiring colored varnishes to create a painted look can only be applied to Maple veneer and require one extra week in addition to the standard lead time. NuCraft’s standard black finish (G82) can be applied to all NuCraft standard veneers. Walnut is the standard black veneer. Other species must be specified when ordering.

Clear coat on a special veneer requires an approved sample.

Custom finishes carry a 10% upcharge per item, per finish, capped at \$1,975 List.

Custom finish upcharges are not applied to any item that is not wood. Example: casters, ganging connectors, power options..

## Treatments

**Note: Default veneer sheen will vary per finish and product. Default finish is bolded on pages vi-vii. If no direction is provided on incoming orders, default sheen will be selected. In addition, default veneer cut is noted in the price list. If no direction is provided on incoming orders, default cut will be selected.**

**Gloss:** Gloss is a durable finish that tends to nicely mask normal wear and leaves wood grain visible to the eye. It achieves a medium gloss open pore appearance (40 – 50 sheen range). Finish numbers preceded by the letter “G” indicate a Gloss finish.

**Matte:** Like Gloss, Matte is durable, tends to nicely mask normal wear and leaves wood grain visible to the eye. It achieves a low luster, open pore appearance (10 – 20 sheen range). Finish numbers preceded by the letter “M” indicate a Matte finish.

Since each veneer type responds differently to both types of treatment, all will have a distinctive look and feel when finished. For example, a Walnut veneer with a Gloss treatment will remain much more textured than a Cherry veneer with the same treatment.

## About the Wood

All NuCraft veneers are carefully selected for uniformity of color and grain. Still, wood is a natural substance and minor variations may occur due to its own uniqueness. Because of this, the furniture you receive may not be an exact match to our samples.

NuCraft takes great pride in our finish color consistency. However, wood is a natural product that will have color variation within a single piece of furniture, as well as from one piece to the next. Other factors also affect color over time, such as exposure to light (both intensity and duration). For example, lighter finishes cause more variation in colors over time.

In cases where a returning customer wants a precise match with existing furniture, we recommend sending a sample of the existing furniture finish. Please contact NuCraft Customer Service to determine an appropriate sample. This will ensure a finish match between old and new orders. This type of order is considered a control sample. There will be a 10% upcharge on an order of this type. Due to natural aging of veneers, natural finishes may vary.

## Care and Maintenance of Wood Finishes

Our finish material is a crystal clear, urethane acrylic blend. This type of finish may be repaired in the field by a qualified refinisher.

NuCraft recommends using a damp cloth to clean your fine wood furniture. Always wipe with the grain of the wood. Should your wood furniture require a more thorough cleaning, we recommend using a mild cleaner such as Joy dish soap or Murphy’s oil soap, thoroughly diluted in water (one part soap to thirty parts water). Water will not damage NuCraft’s finish, but it may leave surface spots when it dries. To avoid this, dry the surface with a soft cloth after it is cleaned. Marks that cannot be removed with the cleaning methods above may be able to be removed using naphtha, a mild degreasing solvent.

Caution: while the use of polishes that contain wax, petroleum solvents or silicones may immediately enhance the “shine” of a product, it may also eventually remove the fine original finish applied in our factory. Silicone on the surface of wood may also make it very difficult to respray or refinish.

All NuCraft furniture is inspected and polished before it leaves our factory. In some instances, the packing materials may imprint on the factory polish. Cleaning and polishing the furniture once it is unpacked will normally restore the furniture to its original beauty.

In some cases, the rubber support feet used on the bottom of common office equipment (teleconferencing phones, laptops, microphones, copiers, etc.) can create unsightly marks in the surface of wood tops, due to oxidation of the lacquer finish. We suggest these machines be placed on a protective type of padding, such as felt.

Wood will fade as a result of exposure to UV light. This is particularly prevalent with light finishes. If color changes due to fading are a concern for your application, the impact can be minimized by selecting medium to dark stains for your wood surfaces. Our top coat includes a UV inhibitor which makes the finishes less prone to fading.



# FINISH INFORMATION

## Laminates

Selected Formica® and Nevamar® laminates are available on Training Tables, Conference Tables, Conference Room Furniture and select Occasional Tables. For standard laminate and wood pricing, refer to individual item pricing columns.

## Non-Standard Laminates and Linoleums

To order a color other than those on our list (see pages vi-vii), refer to Nevamar or Formica standard grade, matte texture laminate offerings and Forbo Furniture Linoleums (excluding manufacturers' non-standard matte offering).

- For approved non-standard laminates with a hardwood edge, the upcharge is 10% of the base price per laminate color with a minimum of \$500 and capped at \$1975.
- For approved non-standard laminate with a standard ABS edge, the upcharge is \$175 per laminate color.
- For approved non-standard laminates with a non standard ABS edge, please contact customer service.

To ensure your non standard laminate is on our approved list, please contact customer service. Add one week to the lead-time for all non-standard laminate and linoleum orders. Call the Nucraft Customer Service team for quotes on premium grades and laminates. Mirror and metal laminates are not available.

## Care and Maintenance of Laminate and Novawrap

Laminate and Novawrap surfaces may be cleaned with a damp cloth and ordinary soap or non-abrasive household liquid detergent. Dry the surface with a clean cloth or soft paper towel to prevent streaks from appearing.

## Care and Maintenance of Metal

Metal surfaces can be wiped with a damp cloth and rubbed dry. A mild non-abrasive household liquid detergent can be used if necessary. Regular maintenance of metal components, including tightening of fasteners and light lubrication of moving parts, will extend the life of your furniture.

## Satin Etched Glass

Glass color may vary slightly on multi-piece conference table tops over 180" x 60" when satin etched glass is specified due to the iron content and etching process of the glass.

## Care and Maintenance of Glass

Clear or frosted glass may be cleaned with commercial glass cleaner. Be sure to use a lint-free cloth if cleaning the frosted side of the glass.

## Stone and Solid Surface Material

Despite its reputation for durability, natural stone can easily be broken during handling and/or installation if proper techniques are not followed. In addition, Nucraft is not responsible for the installation of natural stone or solid surface materials on its products. Therefore, installers specifically trained in the installation of these materials must be utilized to ensure a quality installation. Nucraft shall not be liable for any damages incurred during the handling and/or installation of natural stone or solid surface materials on its products.

## Care and Maintenance of Granite

Granite surfaces may be cleaned with a damp cloth and ordinary soap or non-abrasive household liquid detergent. Dry the surface with a clean cloth or soft paper towel to prevent streaks from appearing.

## Care and Maintenance of Leather

Genuine leather requires very little care. Nucraft recommends that leather be dusted regularly. If a more thorough cleaning is needed, use lukewarm water and a mild, non-abrasive soap. Generate some lather and lightly rub the surface with cheesecloth. Rinse off any soap film with clean water and towel dry. The leather may dry dull. To restore the leather to a normal gloss, rub it with a clean towel. Never use furniture polish, oil, varnish or ammonia. Saddle soap may be used to prevent the leather from becoming brittle or cracked and to maintain the original supple finish.

## Touch Up Finish Kits

Model #	Description	Price
KIT-M	Metal Kit	80
KIT-P	Paint Kit	80
KIT-S	Stain Kit	80

### REQUIRED INFORMATION:

#### (ORDER CANNOT BE ENTERED WITHOUT THIS INFORMATION)

- Kit model number
- Quantity of kits
- Specify finish (See pages vi-vii)

### General Information:

- Touch-up kits must be ordered on a purchase order separate from Nucraft product due to Hazmat shipping



# TWO4SIX™ SURFACE MATERIALS

## WOOD FINISHES

### STANDARD

Default veneer sheen will vary per finish and were determined by a team of experts who reviewed the colorways to determine if gloss or matte best highlighted the natural characteristics of the species of wood and the color of the stain. Default finish is bolded. If no direction is provided, default sheen will be selected.

	Matte	Gloss
<b>Ash</b>		
Blanco	<b>M44</b>	G44
Char	<b>M50</b>	G50

### Rift Cut Oak

Carbon	M03	<b>G03</b>
--------	-----	------------

### Flat Cut Oak

Dune	<b>M05</b>	G05
Portobello	<b>M7413</b>	G7413

### Flaky Oak

Sahara	<b>M61</b>	G61
--------	------------	-----

### Cherry

Cognac	M21	<b>G21</b>
Auburn	M93	<b>G93</b>

### Walnut

Marron	<b>M35</b>	G35
Mocha	<b>M33</b>	G33
Zinc	M30	<b>G30</b>
Onyx	M82	<b>G82</b>
Otter	M31	<b>G31</b>

### Maple

Natural Maple	M60	<b>G60</b>
---------------	-----	------------

### Linea

Oak Linea	<b>M08</b>	G08
Walnut Linea	<b>M27</b>	G27
Euro Birch Linea	<b>M09</b>	G09
Silver Birch Linea	M10	<b>G10</b>

### Paldao

Thicket	<b>M75</b>	G75
Paldao	<b>M76</b>	G76
Canyon	M77	<b>G77</b>

## METAL FINISHES

### Powder Coat

Aged Bronze	A8010
Black	A44
Burnished	A8009
Cloud	A8004
Foil	A8006
Galaxy	A8007
Satin Bronze	A8011
Shadow	A8005
Storm	A8012

### Metal

Clear Anodized*	CA
Polished Chrome**	PC

\* Not available on Open Frame Base

\*\*Up-Charge applies. See specific product line pages for availability and details.

## PAINTS

Aged Bronze	S8010
Black	S44
Burnished	S88
Cloud	S8004
Foil	S8006
Galaxy	S8007
Moonlight	S87
Satin Bronze	S8011
Shadow	S8005
Storm	S8012

### Paint to Match

To request a custom paint color, contact Nucraft Customer Service. A paint sample must be matched and approved prior to order.



## STONE TOPS

Stone orders may affect lead times. Please contact Nucraft Customer Service for details.

		<b>Subtop Paint Color</b>
<b>Quartz   Cambria® Signature</b>		
Ainsley	STC100	S8004
Armitage	STC101	S44
Bellingham	STC102	S8004
Berkeley	STC103	S8004
Berwyn	STC104	S8004
Blackbrook	STC105	S44
Bradshaw	STC106	S8004
Bradwell	STC107	S8004
Cambria Black	STC109	S44
Carrick	STC110	S44
Clifton	STC112	S8004
Colton	STC113	S8004
Crowndale	STC114	S8004
Devon	STC115	S44
Fairbourne	STC116	S8004
Fieldstone	STC117	S44
Halewood	STC119	S8004
Hermitage	STC120	S8004
Highgate	STC121	S8004
Kendal	STC122	S8004
Laneshaw	STC124	S44
Malvern	STC125	S8004
Montgomery	STC128	S8004
Nevern	STC129	S8004
New Quay	STC130	S8004
Pendle Hill	STC131	S8004
Praa Sands	STC132	S8004
Rose Bay	STC133	S8004
Sandgate	STC135	S8004
Smithfield	STC136	S8004
Summerhill	STC137	S8004
Sutherland	STC138	S8004
Swanbridge	STC139	S8004
Torquay	STC140	S8004
Travella	STC141	S8004
Weybourne	STC143	S8004
Whitney	STC144	S8004
Woodcroft	STC146	S44

## Quartz | Cambria® Luxury

Abbey	STC147	S8004
Annicca	STC148	S8004
Baybridge	STC149	S8004
Beckington	STC150	S8004
Bentley	STC151	S8004
Blackpool Matte	STC152	S44
Brittanicca	STC153	S8004
Brittanicca Gold Cool	STC154	S8004
Brittanicca Gold Warm	STC155	S8004
Brittanicca Warm	STC156	S8004
Clovelly	STC158	S8004
Delamere	STC159	S44
Delgatie	STC160	S8004
Ella	STC161	S8004
Everleigh	STC162	S8004
Gladstone	STC163	S8004
Golden Dragon	STC164	S44
Hailey	STC165	S8004
Harlow	STC166	S8004
Hemsworth	STC167	S8004
Huntley	STC168	S8004
Inverness Bristol Bay	STC169	S8004
Inverness Bronze	STC170	S8004
Inverness Cobalt	STC171	S8004
Inverness Everleigh	STC172	S8004
Inverness Platinum	STC173	S8004
Inverness Swansea	STC174	S8004
Ironsbridge	STC175	S8004
Iverness Frost	STC176	S8004
Iverness Gold	STC177	S8004
Ivybridge	STC178	S8004
Lakedale	STC179	S8004
Mayfair	STC181	S8004
Mersey	STC182	S44
Notting Hill	STC183	S8004
Oakleigh	STC184	S8004
Portrush	STC185	S8004
Queen Anne	STC186	S8006
Skara Brae	STC187	S8004
Southport	STC188	S8004
White Cliff	STC189	S8004

## Quartz | Wilsonart

Carrara Codena	ST21	S8004
Serene	ST17	S8004

## Stone

Absolute Black Honed Granite	ST01	S8007
Carrara Marble	ST16	S8004



## SOLID SURFACE TOPS

Wilsonart Designer White ST11

## GLASS (SATIN OR GLOSS)

	Satin	Gloss
Black	BS	-
Clove	VS	VG
Meringue	MS	MG
Quill	QS	QG
White	WS	WG

## LAMINATES

Wood Grain Laminates <sup>§</sup>	Code	Coordinating Wood Finish	Coordinating Woodgrain Edgeband
Formica White Ash	8841-58	M8841	R8841
Formica Natural Ash	8843-58	M8843	R8843
Formica Aged Ash	8844-58	M8844	R8844
Formica Weathered Ash	8842-58	M8842	R8842
Formica Oiled Legno	8846-58	M8846	R8846
Formica Bleached Legno	8845-58	M8845	R8845
Formica Blackened Legno	8848-58	M8848	R8848
Formica Urban Planked Oak	9312-58	M9312	R9312
Formica Thermo Walnut	6402-58	M6402	R6402
Formica Smoky Brown Pear	5488-58	M5488	R5488
Formica Espresso Pear	5489-58	M5489	R5489
Formica White Knotty Maple	7410-58	M7410	R7410
Formica Sand Maple	9237-58	G60	W7909
Formica Planked Coffee Oak	7413-58	M7413	F7413

<sup>§</sup>Not available on multiple piece conference tables

### Wood Grain Laminates Suitable for Multiple Piece Conference Tables

Formica Pecan Woodline	5883-58	M5883	R5883
Formica Chestnut Woodline	5884-58	M5884	R5884

### Solid Laminates

Formica Brite White	459-58	R01
Formica Dover White	7197-58	R01
Formica Pearl	934-58	R02
Formica Graystone	464-58	R02
Formica Folkstone	927-58	R03
Formica Graphite	837-58	R05

### Patterned Laminates

Nevamar Cool Chic	VA7002T	R02
Nevamar Serene Stardom	VA5001T	R05
Nevamar Calm Distinction	VA6001T	R05
Nevamar Easy Elegance	VA5002T	R05
Wilsonart Sheer Mesh	4876-38	R02
Wilsonart Grey Mesh	4877-38	R02
Wilsonart Pewter Mesh	4878-38	R05

## ABS FINISHES

Ashen	R04
Parchment	R02
Shale	R05
Stone	R03
Whitecap	R01