

**FLOW™**

# Planning Guide + Price List

---

## QUICK LINKS

[PLANNING GUIDE](#)

[FLOW XT PRICING](#)

[FLOW PRICING](#)

[POWER AND DATA OPTIONS](#)

[GENERAL INFORMATION](#)

[FINISH INFORMATION](#)

[SURFACE MATERIALS](#)



# TABLE OF CONTENTS

Click the shortcuts below to jump to each section.

General Information	ii-iii
Finish Information	iv-v
Surface Materials	vi-viii
Statement of Line	3-4
Specification Overview	5
Planning Guide	6-54
Flow XT Tops and Bases	55-55
Flow XT Power and Data Options	67
Flow Tops and Bases	68-118
Power and Data Options	119-129

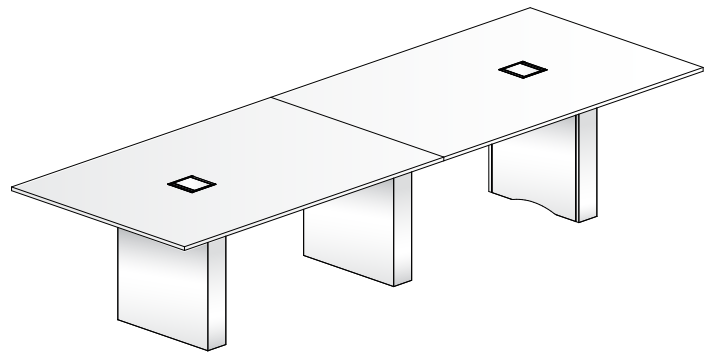
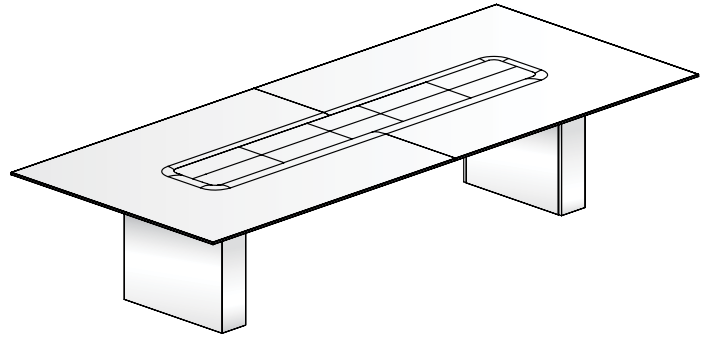



# STATEMENT OF LINE

## FLOW XT CONFERENCE TABLES

---

Pages 55-66



Rectangle



Radius Rectangle

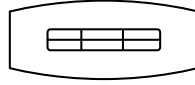

Boat

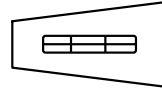

Sight Line

## FLOW XT BASES

---

Pages 55-66

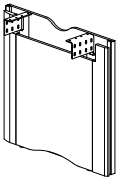

Panel Base

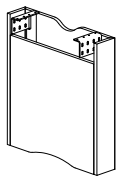

Rectangle Base

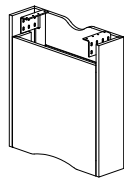

Expandable Rectangle Base

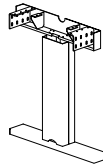

T-Base

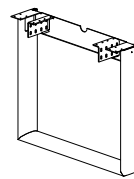

Hoop Base

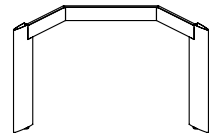

Four Post Base



# STATEMENT OF LINE

## CONFERENCE TABLES

Pages 68-118



Round



Rectangle

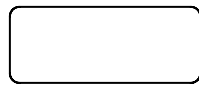

Radius Rectangle

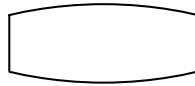

Boat

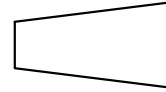

Sight Line

## RECTANGLE, BOAT AND SIGHT LINE BASES

Pages 79-118

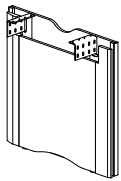

Panel Base

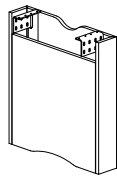

Rectangle Base

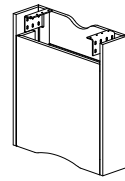

Expandable Rectangle Base

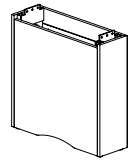

Column Base

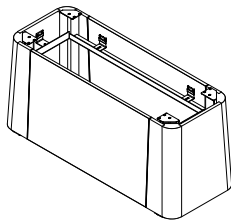

Island Base

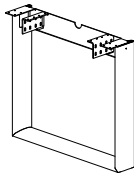

Hoop Base

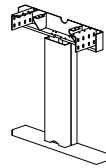

T-Base

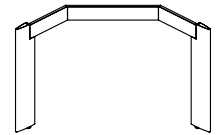

Four Post Base

## ROUND BASES

Page 68-77

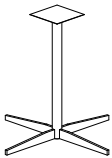

Metal X-Base

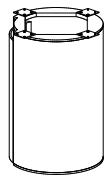

Cylinder Base

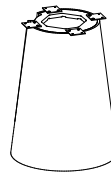

Cone Base

## CAFÉ HEIGHT BASE

Page 78

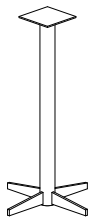

Café Height Base



# SPECIFICATION OVERVIEW

---

## FLOW XT CONFERENCE TABLES (WITH POWER ISLAND)

### 1. Select the Top Surface and Power Island Door Material

Flow XT table tops are available in Standard Veneer. The Power Island doors are available in metal or glass.

### 2. Select the Top Size and Shape

Flow XT conference tables are available in four shapes: Rectangle, Radius Rectangle, Boat and Sight Line. Sizes range from 96" to 240"-long.

### 3. Select Base Style and Finish

Flow XT conference tables are available with the following base options: Panel, Four Post, Rectangle, Expandable Rectangle, Column, T-Base and Hoop Base. All Flow bases except the T-Base, and Hoop Base are available in veneer or paint finishes.

### 4. Select Storage Module (if desired)

## FLOW CONFERENCE TABLES (WITHOUT POWER ISLAND)

### 1. Select the Top Surface Material

Choose between standard veneer, inset laminate with hardwood edge, laminate with ABS edge, glass or stone/quartz. Solid surface is available on round tables only.

### 2. Select the Top Size and Shape

Flow conference tables are available in five shapes: Round, Rectangle, Radius Rectangle, Boat and Sight Line. Sizes range from 36" round to 240"-long. All shapes except Round are available with either two or three bases depending on top size (some stone/quartz top tables have four bases).

### 3. Select Base Style and Finish

Flow conference tables are available with the following base options: Panel, Four Post, Rectangle, Expandable Rectangle, Column, T-Base, Hoop Base and Island. Round tables are available with a Metal X-Base, Cone Base or Cylinder Base. All Flow bases except the T-Base, Hoop Base, and Metal X-Base are available in veneer or paint finishes.

### 4. Select Power Option (if desired)

Table top power and data options include Power Matrix, Tech Node, Power Spec, USB Spec and Grommets. Under surface power options include Perimeter Power and Power Rails (not available on Round tables, Stone/Quartz Top tables, or tables with Four Post base), as well as Charging Trac.

## DETAIL OVERVIEW

### FLOW XT CONFERENCE TABLES (SHOWN WITH EXPANDABLE RECTANGLE BASE)

At the heart of the Flow XT conference tables is the Power Island, an innovative and scalable system that acknowledges the inherent dichotomy between the rate of change in technology and the typical lifespan of quality office furniture, reconciling that difference with ease. Modular componentry allows the table to respond to changes in technology requirements over the life of the table with ease. Flow XT conference tables are available with veneer tops only. Power Island is only available on Flow XT conference tables.

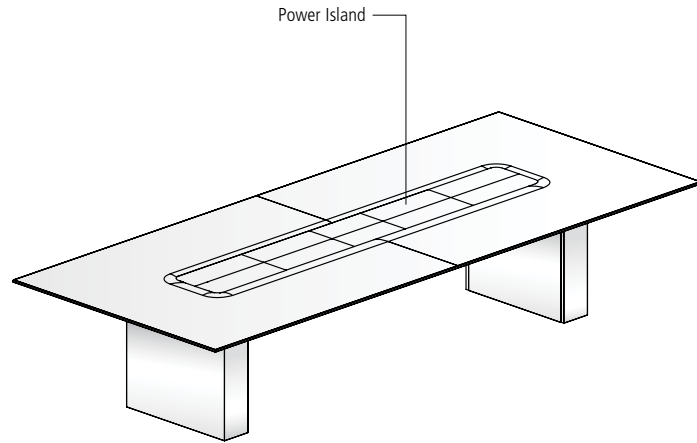

### FLOW CONFERENCE TABLES

Available with veneer, laminate, glass or stone/quartz tops, Flow conference tables offer the ultimate in material and aesthetic choices. A broad range of power & data connectivity options provide scalability for technology accommodation.

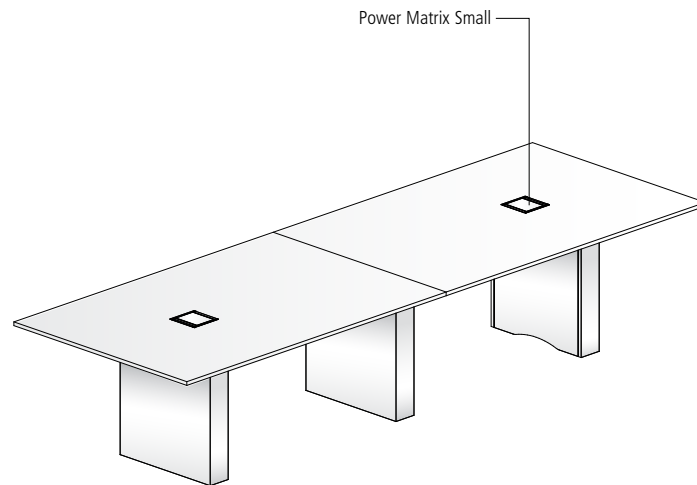



# RECOMMENDED SEATING CAPACITY

## RECTANGLE AND RADIUS RECTANGLE TABLES

Note: Seating capacity is based on 27" per person. Tables 54" and wider seat two people per end.



LENGTH	RECTANGLE AND RADIUS RECTANGLE			WIDTH			
	36"	42"	48"	54"	60"	66"	72"
72	6	6	-	-	-	-	-
78	-	6	-	-	-	-	-
84	-	8	8	-	-	-	-
90	-	8	8	-	-	-	-
96	-	8	8	-	-	-	-
102	-	8	8	-	-	-	-
108	-	10	10	12	-	-	-
114	-	10	10	12	-	-	-
120	-	10	10	12	-	-	-
132	-	-	10	12	-	-	-
144	-	12	14	14	-	-	-
156	-	-	14	14	14	14	-
168	-	-	16	16	16	16	-
180	-	-	16	16	16	16	-
192	-	-	-	18	18	18	-
204	-	-	-	18	18	18	18
216	-	-	-	20	20	20	20
228	-	-	-	20	20	20	20
240	-	-	-	20	20	20	20

## BOAT TABLES

Note: Seating capacity is based on 27" per person. Tables 54" and wider seat two people per end.



LENGTH	BOAT	WIDTH					
	32"/40"	32"/44"	36"/48"	36"/50"	36"/54"	42"/60"	54"/72"
72	6	-	-	-	-	-	-
78	6	-	-	-	-	-	-
84	-	8	-	-	-	-	-
90	-	8	-	-	-	-	-
96	-	-	8	-	-	-	-
102	-	-	8	-	-	-	-
108	-	-	10	-	-	-	-
114	-	-	-	10	-	-	-
120	-	-	-	10	-	-	-
132	-	-	-	-	10	-	-
144	-	-	-	-	12	-	-
156	-	-	-	-	12	-	-
168	-	-	-	-	-	14	-
180	-	-	-	-	-	14	-
192	-	-	-	-	-	-	18
204	-	-	-	-	-	-	18
216	-	-	-	-	-	-	20
228	-	-	-	-	-	-	20
240	-	-	-	-	-	-	20



# RECOMMENDED SEATING CAPACITY

## SIGHT LINE TABLES

Note: Seating capacity is based on 27" per person. Tables 54" and wider seat two people per end.

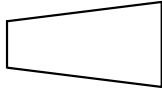

SIGHT LINE LENGTH	WIDTH									
	36"/54"	36"/56"	36"/58"	36"/60"	36"/66"	36"/68"	36"70"	36"/72"	36"/76"	36"/78"
72	7	-	-	-	-	-	-	-	-	-
78	-	7	-	-	-	-	-	-	-	-
84	-	-	9	-	-	-	-	-	-	-
90	-	-	-	9	-	-	-	-	-	-
96	-	-	-	9	-	-	-	-	-	-
102	-	-	-	9	-	-	-	-	-	-
108	-	-	-	11	-	-	-	-	-	-
114	-	-	-	11	-	-	-	-	-	-
120	-	-	-	-	11	-	-	-	-	-
132	-	-	-	-	-	11	-	-	-	-
144	-	-	-	-	-	-	13	-	-	-
156	-	-	-	-	-	-	-	13	-	-
168	-	-	-	-	-	-	-	-	15	-
180	-	-	-	-	-	-	-	-	-	15
192	-	-	-	-	-	-	-	-	-	17
204	-	-	-	-	-	-	-	-	-	17
216	-	-	-	-	-	-	-	-	-	19
228	-	-	-	-	-	-	-	-	-	19
240	-	-	-	-	-	-	-	-	-	19





# TABLE TOP POWER OPTION: POWER ISLAND

## COMPOUND CURVE WIRE CHASE

Compound curve veneering results in a soft, gentle flow into the technology docking zone beneath the floating Power Island.

## ACCESS DOORS

Low-profile access doors are flush with the surrounding table top. Access doors are available in metal or glass.

## STORAGE MODULE (NOT SHOWN)

Provides both a shelf for teleconference phones as well as a 4”-deep storage box to hide technology when it is not being used, hidden below the hinged shelf. A duplex receptacle in one of the inside walls provides convenient power connections and allows equipment to remain connected while in storage. Doors are available in metal or glass. Storage Modules can be specified in the center of the table, at both ends or all three locations, depending on the size of the table. The dimensions of the storage module opening are 12-1/4” wide x 12-3/4” long. The interior dimensions of the center storage module are 15” wide x 14-1/4” long x 4” deep and the end storage module are 15” wide x 13-3/4” long x 4” deep.

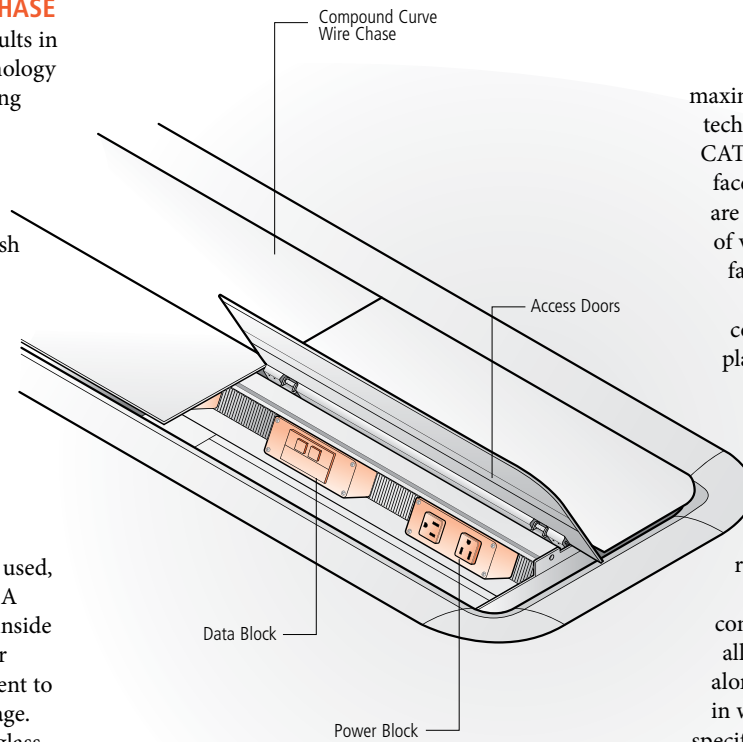

## DATA BLOCK

Utilizing Extron® AAP Plates, these modular components offer maximum flexibility to adapt to future technology needs. Standard with two CAT6 data connectors and one blank faceplate for future use, Data Blocks are also available with a broad range of video, audio and data connection faceplate options and can easily be changed as the technology of the conference room changes. Held in place with two thumb screws, Data Blocks are easy to add, remove or relocate as needed.

## POWER BLOCK

Standard with two simplex receptacles, Power Blocks provide convenient table top power connectivity. Their modular design allows them to be placed anywhere along the length of the Power Island in whatever quantities are needed (a specific quantity is included with each standard table length when the Power Island is specified). They are held in place with two thumb screws making them easy to add, remove or relocate as needed. Power Blocks are also available in hard-wired configurations. Power Blocks simply plug into a two-circuit electrical system that runs along the length of the table, just below the Power Island spine.

## POWER PLANNING

### Flow XT Two-Circuit Electrical System

- 4-wire, 20-amp, 2-circuit modular electrical system.
- All tables are pre-wired.
- Power Island defaults to hardwire infeed option. Plug-in infeed option may also be specified. A licensed electrician is required to complete hardwire connections to building's power source. Hardwire and plug-in infeed options are 42” long.
- Neutral (white) wires are 10 gauge, hot and ground wires are 12 gauge.
- All electrical components satisfy National Electrical Code (NEC) requirements and are UL listed.

### Electrical Diagram — Hardwire Power Infeed Only

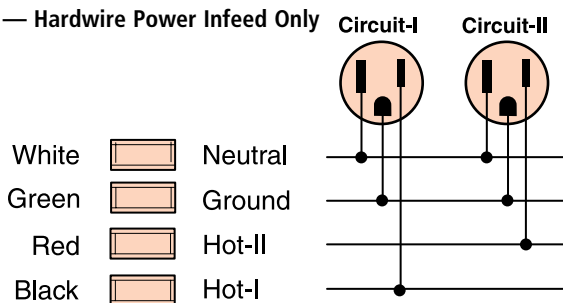



# TABLE TOP POWER OPTION: POWER ISLAND

All Flow conference tables include an ample supply of wire management channels beneath the table top to accommodate even the most technology-intensive environments. In addition, Flow XT conference tables include a shroud to conceal the underside of the Power Island, eliminating the potential for sagging cables to be visible beneath the table top.

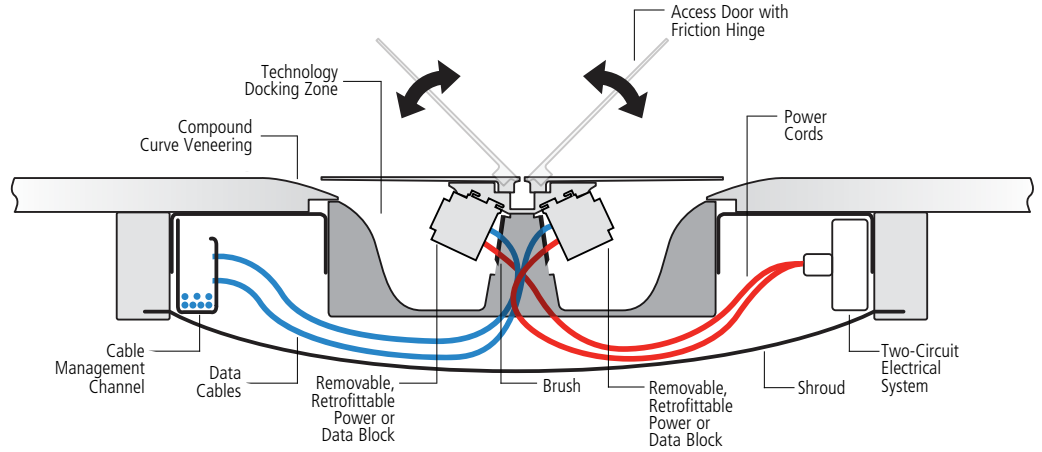

Front Elevation

Side Elevation

Power Block (Two Simplex)

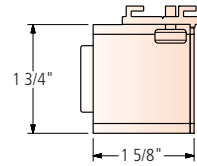
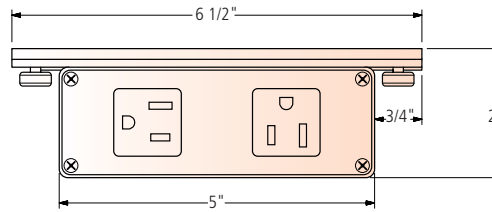

Power Block (Simplex / Charging USB-A+C)

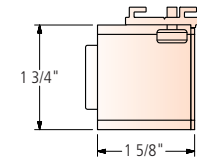
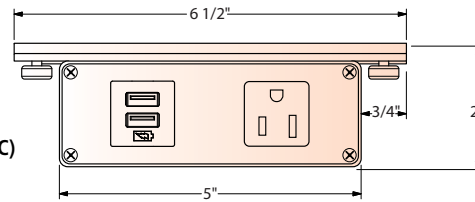

Data Block

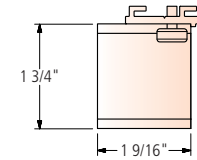
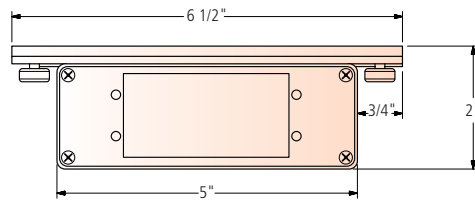



# TABLE TOP POWER OPTION: POWER ISLAND

## STANDARD POWER AND A/V SUPPLY

This chart notes the standard number of Power and Data Blocks supplied with each Flow XT table based on table length. If additional Power or Data Blocks are required, they can be purchased separately.

Please note, adding additional Power Blocks to the table may also require additional components for the electrical system to ensure proper connectivity. Please reach out to Nucraft Customer Service for assistance.

**STANDARD POWER AND A/V SUPPLY (BY TABLE SIZE)**

TABLE LENGTH	POWER BLOCKS	SIMPLEX RECEPTACLES	DATA BLOCKS	DATA CONNECTORS	1 BLANK FACEPLATES
96	4	8	4	8	4
102	4	8	4	8	4
108	4	8	4	8	4
114	4	8	4	8	4
120	4	8	4	8	4
132	4	8	4	8	4
144	8	16	8	16	8
156	8	16	8	16	8
168	8	16	8	16	8
180	8	16	8	16	8
192	8	16	8	16	8
204	8	16	8	16	8
216	8	16	8	16	8
228	8	16	8	16	8
240	8	16	8	16	8

## DIMENSION PLANNING

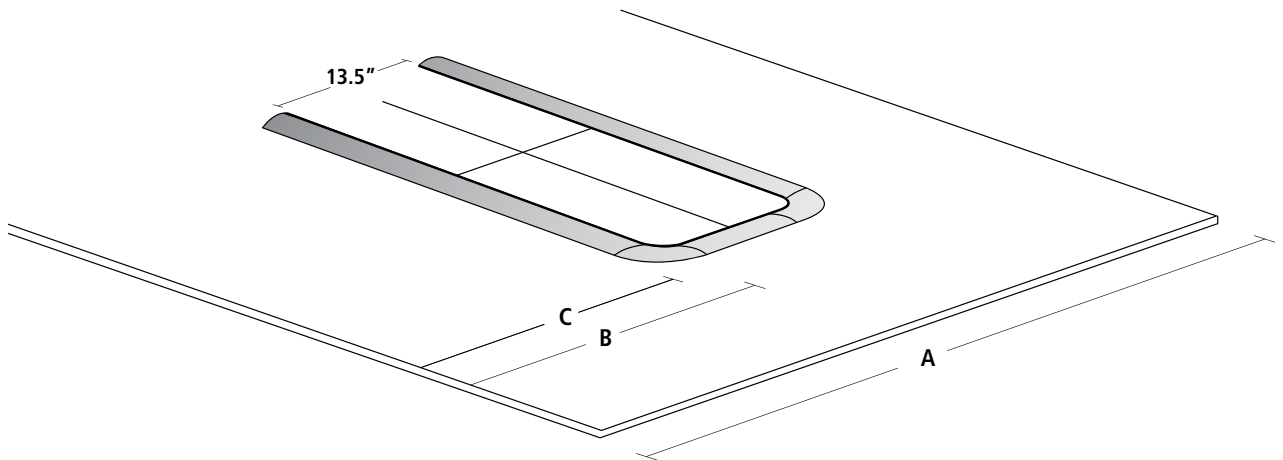

TABLE WIDTH [A]	DIMENSION TO POWER ISLAND DOOR [B]	DIMENSION TO CURVE OF VENEER [C]
42	14.25	12
48	17.25	15
54	20.25	18
60	23.25	21
66	26.25	24
72	29.25	27



# TABLE TOP POWER OPTION: POWER MATRIX

Available in a variety of sizes, styles and connectivity options, Power Matrix is Nucraft's most versatile power option. Power Matrix incorporates a broad array of scalable features and is available across multiple product lines, making it the "go to" solution for power and AV connectivity needs.

Offered in four sizes and two door configurations (single and double), Power Matrix can handle any power and AV connectivity need, from the simplest to the most demanding.

## Small

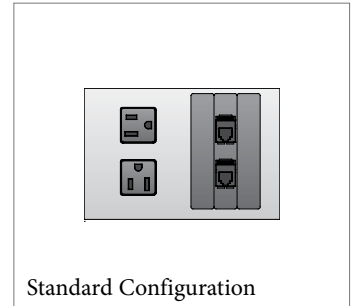
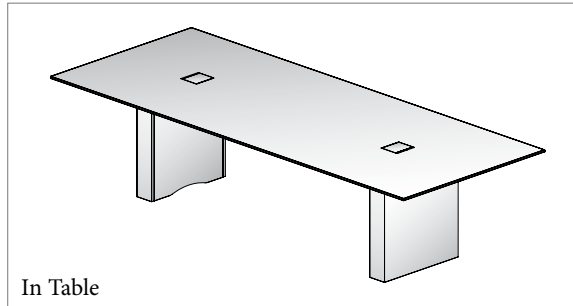

## Medium

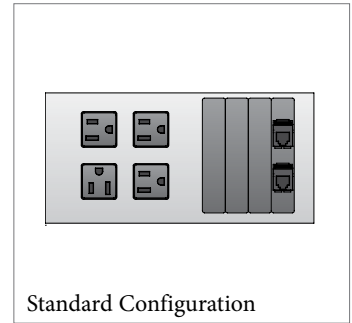
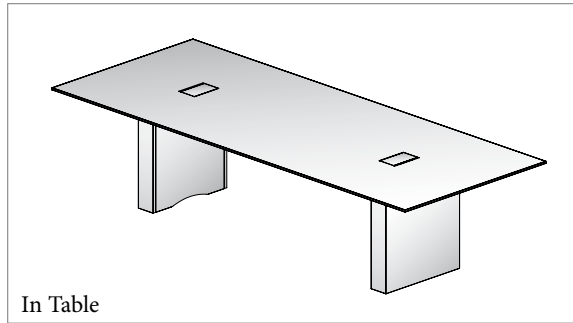
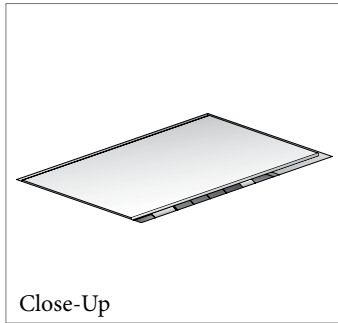

## Large

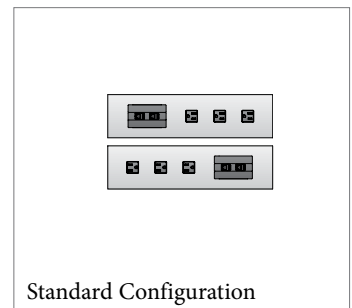
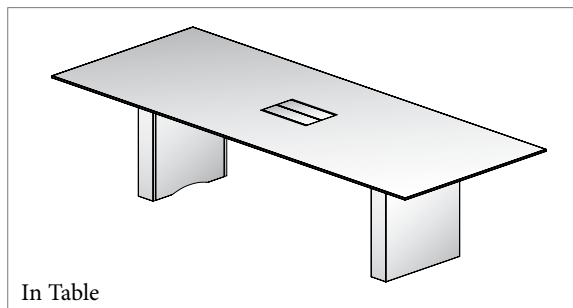
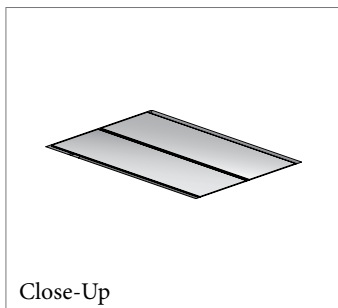

## Extra Large

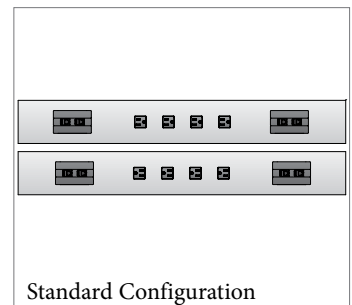
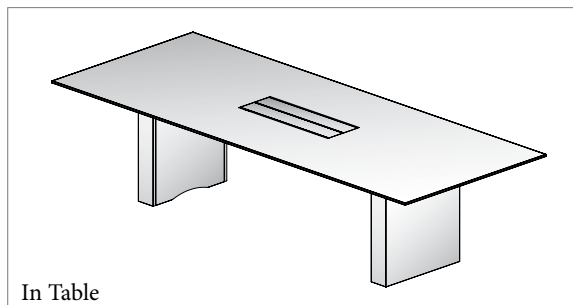
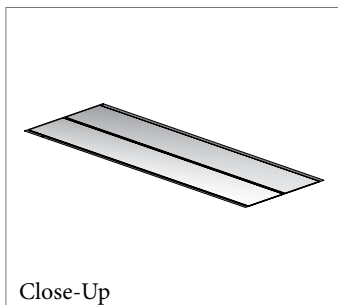

## TABLE TOP POWER OPTION: POWER MATRIX

Power Matrix is filled with a broad array of high performance features and refined aesthetic elements.

### POWER

Power Matrix features simplex receptacles for power connectivity, the quantity of which is pre-determined based on the size of the unit. An optional USB-A+C charger can also be specified in place of one of the simplex receptacles when desired. Corded or hardwired infeed options add flexibility.

### DATA/AV FACEPLATES

Power Matrix accommodates Extron Architectural Adaptor Plates (AAPs) for unparalleled flexibility in data and AV connectivity.

### DESIGN

Power Matrix units feature a clear anodized aluminum body and a bezel-free flush mount design on wood tables for an elegant appearance. Laminate, glass, solid surface and stone/quartz table tops include a bezel, available in powder coat, polished chrome or clear anodized finish options.

### PERFORMANCE

Friction hinges ensure smooth travel through the door's range of motion and can hold the door in any position. Hidden door stops maintain the minimalist aesthetic. Cable storage is both concealed and ample.

### DOORS

Power Matrix is offered in multiple door material options, including metal, glass and grain-matched wood cut from the same table top.

(Medium size shown)

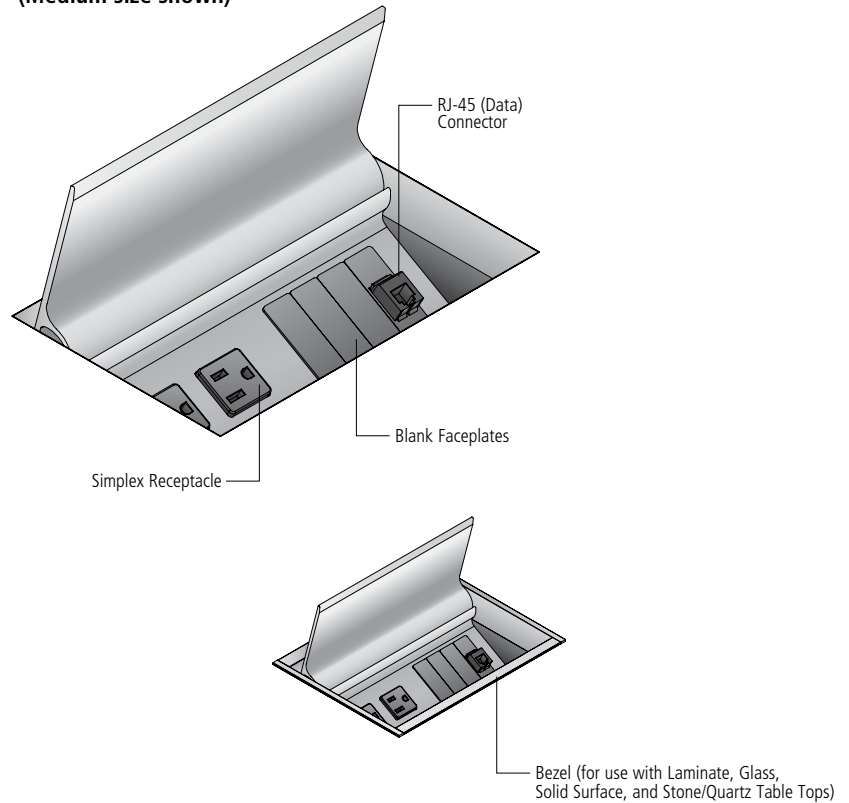



# TABLE TOP POWER OPTION: POWER MATRIX

## STANDARD CONFIGURATIONS

Power Matrix is offered in four standard sizes, each with a pre-determined quantity of simplex outlets and AV faceplates. With each size, an optional 2 amp USB-A+C charger (1 amp per port) replaces one of the simplex outlets.

### Small and Compact

- Single door design
- 5.375" x 6" cutout
- Two simplex outlets
- Three AV faceplates. Standard configuration includes two blank faceplates and one faceplate with two RJ-45 (data) connectors.
- (1) 12' plug-in infeed cord

#### Standard

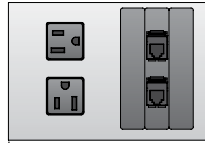

### Medium

- Single door design
- 5.375" x 8.25" cutout
- Four simplex outlets
- Four AV faceplates. Standard configuration includes three blank faceplates and one faceplate with two RJ-45 (data) connectors.
- (1) 12' plug-in infeed cord

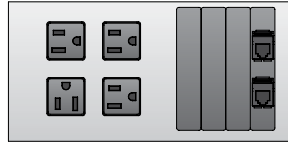

### Large

- Double door design
- 10.75" x 15.25" cutout
- Six simplex outlets (three per side)
- Six AV faceplates (three per side). Standard configuration includes two blank faceplates and one faceplate with two RJ-45 (data) connectors per side.
- (2) 12' plug-in infeed cords

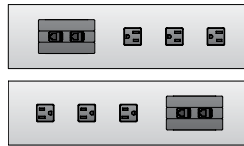

### Extra Large

- Double door design
- 10.75" x 30.25" cutout
- Eight simplex outlets (four per side)
- Twelve AV faceplates (six per side). Standard configuration includes four blank faceplates and two faceplates with two RJ-45 (data) connectors per side.
- (2) 12' plug-in infeed cords



## Field-Wired

Some local electrical codes may require field-wiring during installation. In such instances, a Field-Wired option may be specified. In this configuration, each Power Matrix unit will be supplied with a 6' flexible metal conduit with hot, ground and neutral wires.

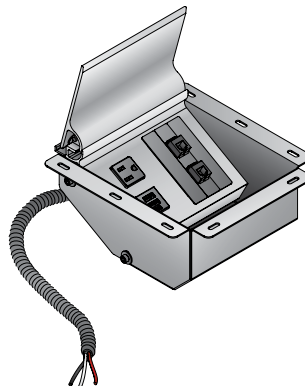



# TABLE TOP POWER OPTION: POWER MATRIX

## DIMENSIONS

Each Power Matrix unit includes a low-profile pan beneath the work surface to conceal the unit and provide ample storage capacity for excess cables. The size of the cut-out in the table top varies with each size of Power Matrix unit.

### Small

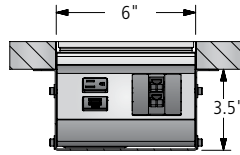
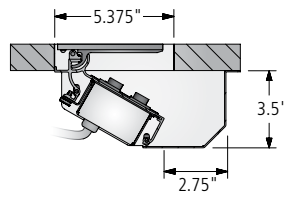

### Compact

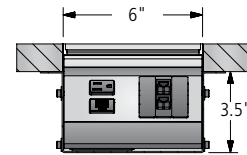
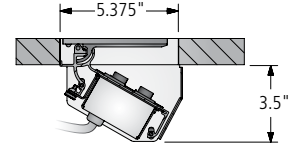

### Medium

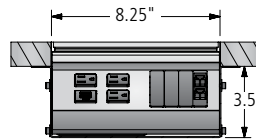
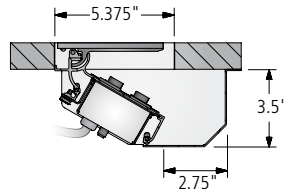

### Large

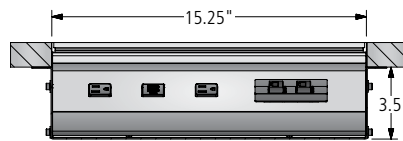
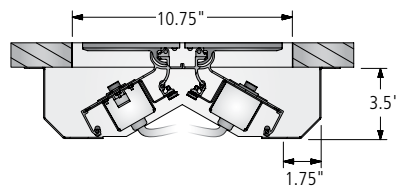

### Extra Large

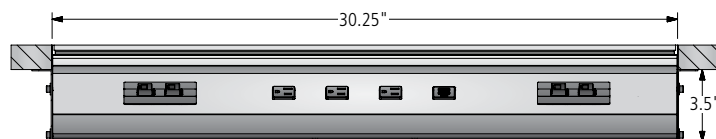
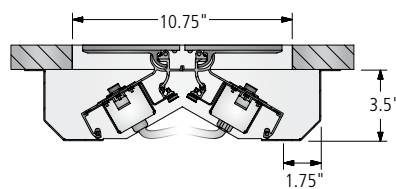

# TABLE TOP POWER OPTION: POWER MATRIX

## POWER PLANNING

Power Matrix is available with two options for connection with building power:

### DIRECT PLUG-IN

The 15-amp power cord from each Power Matrix unit is plugged into a floor monument. The floor monument must have at least one power outlet per small or medium Power Matrix unit in the table and two power outlets per large or extra large Power Matrix (e.g., a table with four small or medium Power Matrix units would need four power outlets in the floor monument).

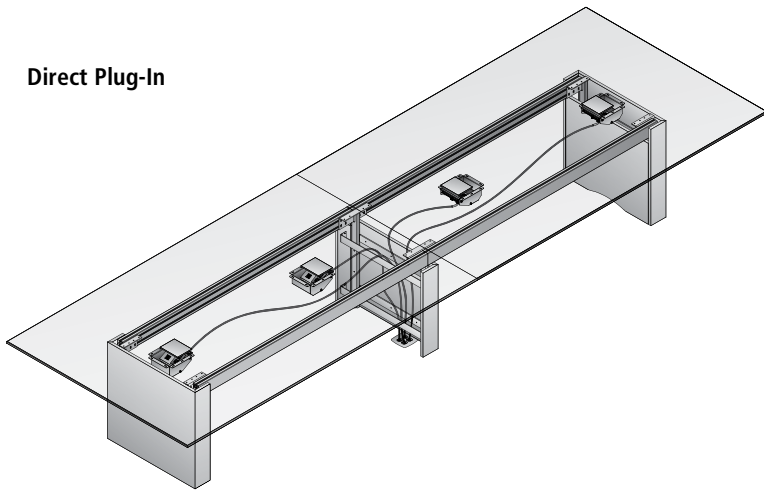

### SINGLE INFEEED

Each Power Matrix unit is plugged into a two-circuit modular electrical system in the table from which a single connection is made to a floor monument. This connection can be either hardwired (to utilize both of the circuits in the modular electrical system) or corded (which requires a 20-amp power outlet in the floor monument and reduces the modular electrical system in the table to a single circuit).

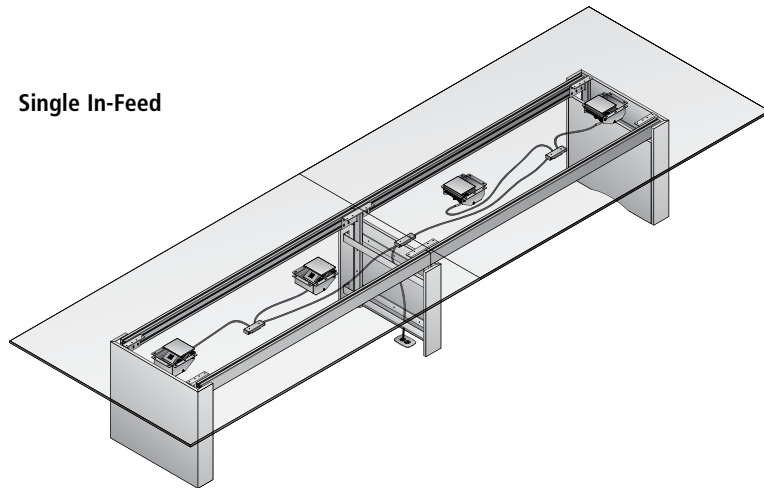

### Two-Circuit Modular Electrical System

- 4-wire, 20-amp, 2-circuit modular electrical system
- Only present on tables specified with the Single In-Feed option
- Hardwire or corded (20-amp) in-feed options. A licensed electrician is required to complete hardwire connections to building's power source.
- Neutral (white) wires are 10 gauge, hot and ground wires are 12 gauge
- All electrical components satisfy National Electrical Code (NEC) requirements and are UL listed

### Electrical Diagram — Hardwire Power Infeed Only

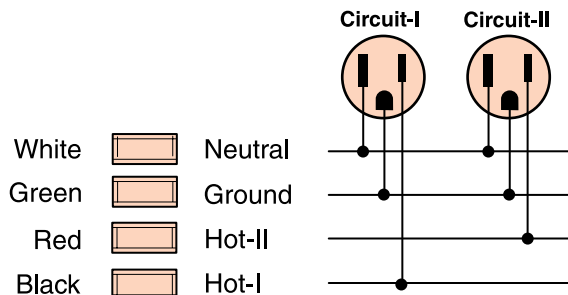





# TABLE TOP POWER OPTION: POWER MATRIX

## LOCATION CODES

Power Matrix is offered in a variety of locations and quantities per table size, offering a broad range of performance and pricing options.

POWER MATRIX SMALL	POWER MATRIX MEDIUM	POWER MATRIX LARGE	POWER MATRIX EXTRA LARGE	LOCATION	QUANTITY OF UNITS TO ORDER
PS-1	PM-1	PL-1	PX-1	One at center	1
PS-2	PM-2	PL-2	PX-2	One at each end	2
PS-3	PM-3	PL-3	PX-3	One at center and one at each end	3
PS-4	PM-4			Four equally spaced (tables 132" and longer)	4

## ROUND TABLES WITH CONE BASE: DOOR MATERIAL AND LOCATION AVAILABILITY BY TABLE SIZE

W = Wood Door (Veneer top tables only)    G = Glass Door    M = Metal Door

Length	Top Sections*	Power Matrix Compact		Power Matrix Small		Power Matrix Medium	
		PS-1	PS-2	PS-1	PS-2	PM-1	PM-2
36	1	W/G/M	-	-	-	-	-
42	1	W/G/M	-	-	-	-	-
48	1	W/G/M	-	-	-	-	-
54	1	W/G/M	-	-	-	-	-
60	1	W/G/M	-	-	-	-	-
66	2	-	W/G/M	-	-	-	-
72	2	-	W/G/M	-	-	-	-
84	2	-	W/G/M	-	-	-	-

## ROUND TABLES WITH CYLINDER BASE: DOOR MATERIAL AND LOCATION AVAILABILITY BY TABLE SIZE

W = Wood Door    G = Glass Door    M = Metal Door

Length	Top Sections*	Power Matrix Compact		Power Matrix Small		Power Matrix Medium	
		PS-1	PS-2	PS-1	PS-2	PM-1	PM-2
36	1	-	-	W/G/M	-	W/G/M	-
42	1	-	-	W/G/M	-	W/G/M	-
48	1	-	-	W/G/M	-	W/G/M	-
54	1	-	-	W/G/M	-	W/G/M	-
60	1	-	-	W/G/M	-	W/G/M	-
66	2	-	W/G/M <sup>†</sup>	-	W/G/M	-	W/G/M
72	2	-	-	-	W/G/M	-	W/G/M
84	2	-	-	-	W/G/M	-	W/G/M

PLEASE NOTE: Wood Door option is only available on Veneer top tables

\*Top Section information applies to Veneer, Plank Veneer, Laminate and Solid Surface tops

<sup>†</sup> Available on Stone top tables only



# TABLE TOP POWER OPTION: POWER MATRIX

## ALL RECTANGLE, BOAT AND SIGHT LINE TABLES: DOOR MATERIAL AND LOCATION AVAILABILITY BY TABLE SIZE

W = Wood Door    G = Glass Door    M = Metal Door

Length	Top Sections	Power Matrix Small or Compact				Power Matrix Medium				Power Matrix Large			Power Matrix Extra Large		
		PS-1	PS-2	PS-3	PS-4	PM-1	PM-2	PM-3	PM-4	PL-1	PL-2	PL-3	PX-1	PX-2	PX-3
72	1	W/G/M	W/G/M	-	-	W/G/M	W/G/M	-	-	-	-	-	-	-	-
84	1	W/G/M	W/G/M	-	-	W/G/M	W/G/M	-	-	-	-	-	-	-	-
90	1	W/G/M	W/G/M	-	-	W/G/M	W/G/M	-	-	-	-	-	-	-	-
96	1	W/G/M	W/G/M	W/G/M	-	W/G/M	W/G/M	W/G/M	-	W/G/M	-	-	W/G/M	-	-
102	1	W/G/M	W/G/M	W/G/M	-	W/G/M	W/G/M	W/G/M	-	W/G/M	-	-	W/G/M	-	-
102	2	-	W/G/M	-	-	-	W/G/M	-	-	G/M	-	-	G/M	-	-
108	1	W/G/M	W/G/M	W/G/M	-	W/G/M	W/G/M	W/G/M	-	W/G/M	-	-	W/G/M	-	-
108	2	-	W/G/M	-	-	-	W/G/M	-	-	G/M	-	-	G/M	-	-
114	1	W/G/M	W/G/M	W/G/M	-	W/G/M	W/G/M	W/G/M	-	W/G/M	-	-	W/G/M	-	-
114	2	-	W/G/M	-	-	-	W/G/M	-	-	G/M	-	-	G/M	-	-
120	1	W/G/M	W/G/M	W/G/M	-	W/G/M	W/G/M	W/G/M	-	W/G/M	-	-	W/G/M	-	-
120	2	-	W/G/M	-	-	-	W/G/M	-	-	G/M	-	-	G/M	-	-
132	2	-	W/G/M	-	W/G/M	-	W/G/M	-	W/G/M	G/M	-	-	G/M	-	-
144	2	-	W/G/M	-	W/G/M	-	W/G/M	-	W/G/M	G/M	W/G/M <sup>†</sup>	-	G/M	W/G/M	-
156	2	-	W/G/M	-	W/G/M	-	W/G/M	-	W/G/M	G/M	W/G/M <sup>†</sup>	-	G/M	W/G/M	-
168	2	-	W/G/M	-	W/G/M	-	W/G/M	-	W/G/M	G/M	W/G/M <sup>†</sup>	-	G/M	W/G/M	-
180	2	-	W/G/M	-	W/G/M	-	W/G/M	-	W/G/M	G/M	W/G/M <sup>†</sup>	-	G/M	W/G/M	-
192	2	-	W/G/M	-	W/G/M	-	W/G/M	-	W/G/M	G/M	W/G/M	-	G/M	W/G/M	-
192	4	-	W/G/M	-	W/G/M	-	W/G/M	-	W/G/M	G/M	G/M	-	G/M	G/M	-
204	2	-	W/G/M	-	W/G/M	-	W/G/M	-	W/G/M	G/M	W/G/M	-	G/M	W/G/M	-
204	4	-	W/G/M	-	W/G/M	-	W/G/M	-	W/G/M	G/M	G/M	-	G/M	G/M	-
216	2	-	W/G/M	-	W/G/M	-	W/G/M	-	W/G/M	G/M	W/G/M	G/M	G/M	W/G/M	G/M
216	4	-	W/G/M	-	W/G/M	-	W/G/M	-	W/G/M	G/M	G/M	G/M	G/M	G/M	G/M
228	2	-	W/G/M	-	W/G/M	-	W/G/M	-	W/G/M	G/M	W/G/M	G/M	G/M	W/G/M	G/M
228	4	-	W/G/M	-	W/G/M	-	W/G/M	-	W/G/M	G/M	G/M	G/M	G/M	G/M	G/M
240	2	-	W/G/M	-	W/G/M	-	W/G/M	-	W/G/M	G/M	W/G/M	G/M	G/M	W/G/M	G/M
240	4	-	W/G/M	-	W/G/M	-	W/G/M	-	W/G/M	G/M	G/M	G/M	G/M	G/M	G/M

<sup>†</sup>Sightline tables 144"-180" in length will have three top sections and can only accommodate the glass or metal door options for Power Matrix Large when PL-2 is specified.



# TABLE TOP POWER OPTION: POWER MATRIX

## POWER MATRIX COMPACT, SMALL OR MEDIUM LOCATION OPTIONS

Please Note: For floor core placement, please reference base location information on pages 51-54.

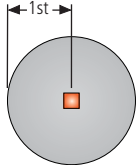

PS-1 or PM-1

\*PS-1 and PM-1 not available with Metal-X Base (-XB).  
PM-1 not available with Cone base (-PCN or -VCN).

PS-1 or PM-1	
Diameter	Center of Power Matrix
36	18
42	21
48	24
54	27
60	30

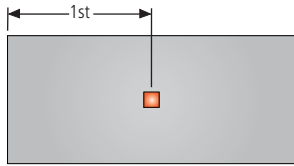

PS-1 or PM-1

PS-1 or PM-1	
Length	Center of Power Matrix
72	36
84	42
90	45
96	48
102	51
108	54
114	57
120	60

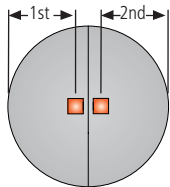

PS-2 or PM-2

\*PS-2 and PM-2 not available with Metal-X Base (-XB) or 66"D Stone table.  
PM-2 not available with Cone base (-PCN or -VCN).

PS-2 or PM-2		
Diameter	Center of 1st Power Matrix	Center of 2nd Power Matrix
66	27	27
72	30.5	30.5
84	35	35

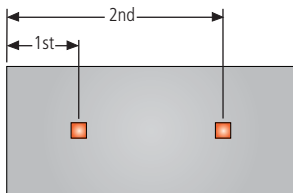

PS-2 or PM-2

PS-2 or PM-2		
Length	Center of 1st Power Matrix	Center of 2nd Power Matrix
72	26	46
78	26	52
84	26	58
90	26	64
96	26	70
102	26	76
108	26	82
114	26	88
120	26	94
132	26	106
144	26	118
156	26	130
168	26	142
180	26	154
192	26	166
204	26	178
216	26	190
228	26	202
240	26	214



# TABLE TOP POWER OPTION: POWER MATRIX

## POWER MATRIX COMPACT, SMALL OR MEDIUM LOCATION OPTIONS

**Please Note:** For floor core placement, please reference base location information on pages 51-54.

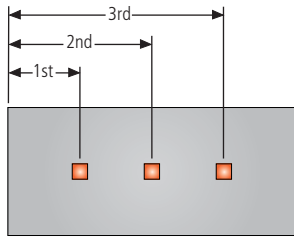

PS-3 or PM-3

PS-3 or PM-3			
Length	Center of 1st Power Matrix	Center of 2nd Power Matrix	Center of 3rd Power Matrix
96	26	48	70
102	26	51	76
108	26	54	82
114	26	57	88
120	26	60	94

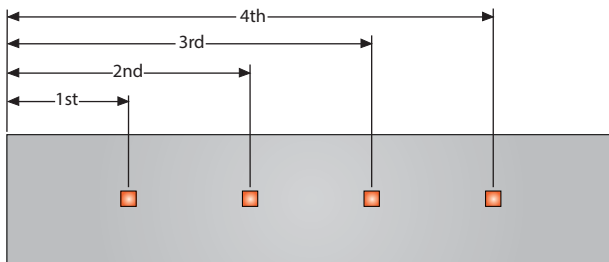

PS-4 or PM-4

PS-4 or PM-4				
Length	Center of 1st Power Matrix	Center of 2nd Power Matrix	Center of 3rd Power Matrix	Center of 4th Power Matrix
132	26	53	79	106
144	26	57	87	118
156	26	61	95	130
168	26	65	103	142
180	26	69	111	154
192	26	73	119	166
204	26	77	127	178
216	26	81	135	190
228	26	85	143	202
240	26	89	151	214



# TABLE TOP POWER OPTION: POWER MATRIX

## POWER MATRIX LARGE OR EXTRA LARGE LOCATION OPTIONS

Please Note: For floor core placement, please reference base location information on pages 51-54.

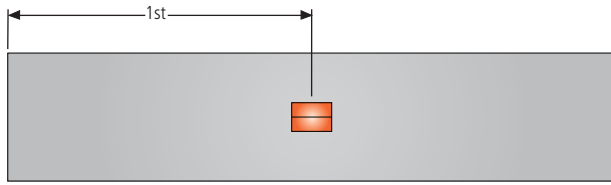

PL-1 or PX-1

PL-1 or PX-1	
Length	Center of Power Matrix
96	48
102	51
108	54
114	57
120	60
132	66
144	72
156	78
168	84
180	90
192	96
204	102
216	108
228	114
240	120

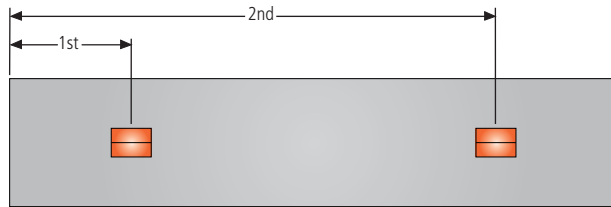

PL-2 or PX-2

PL-2 or PX-2		
Length	Center of 1st Power Matrix	Center of 2nd Power Matrix
144	45	99
156	47	109
168	50	118
180	53	127
192	48	144
204	51	153
216	54	162
228	57	171
240	60	180

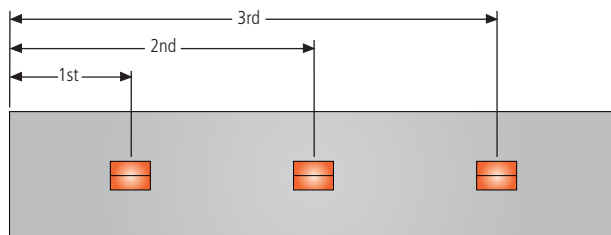

PL-3 or PX-3

PL-3 or PX-3			
Length	Center of 1st Power Matrix	Center of 2nd Power Matrix	Center of 3rd Power Matrix
216	54	108	162
228	57	114	171
240	60	120	180



# RETRACTORS FOR POWER MATRIX

## RETRACTORS

Cable retractors, for use with Power Matrix Small and Medium only, mount directly to the underside of conference room tables using the included mounting bracket. Loaded with 12' of cable that extends out 5' from the retractor. Retractors have a female input from the building infrastructure and a male connector on the output side. Not available on round tables.

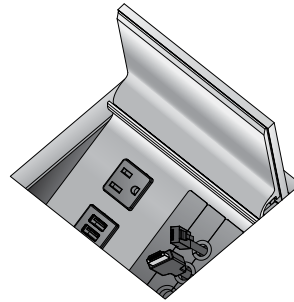

**RETRACTOR AVAILABILITY ON FLOW TABLES**  
**X = AVAILABLE AS STANDARD**

Length	PS-1/ PM-1	PS-2/ PM-2	PS-3/ PM-3	PS-4/ PM-4
72	X			
78	X			
84	X	X		
90	X	X		
96	X	X		
102	X	X		
108	X	X		
114	X	X	X	
120	X	X	X	
132		X		
144		X		X
156		X		X
168		X		X
180		X		X
192		X		X
204		X		X
216		X		X
228		X		X
240		X		X

### Retractor Wire Management

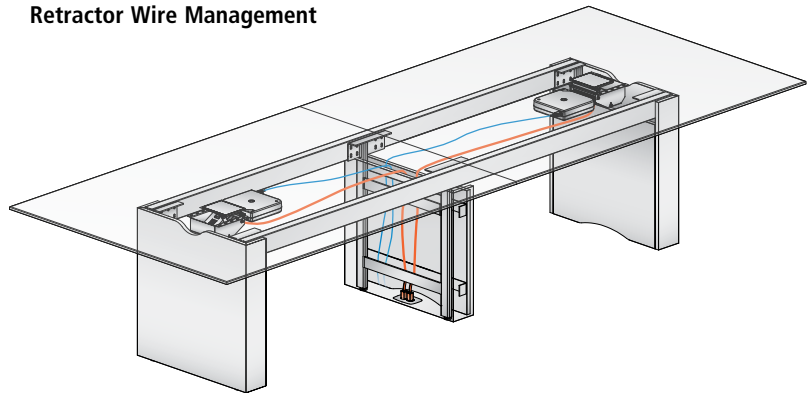

### CAT6 Retractor

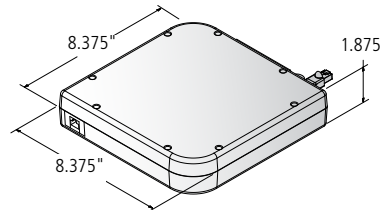

### HDMI Retractor

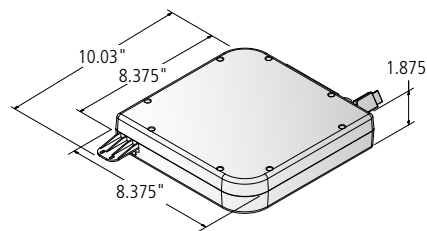

### Data USB Retractor

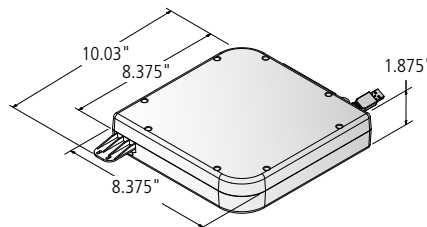



# TABLE TOP POWER OPTION: TECH NODE

Tech Node offers convenient access to power and voice/data connections. Tech Node features include a push/push open design that conceals internal components.

Tech Node components:

- Clear or Black Anodized Aluminum
- Fluid one touch accessibility
- Two (2) Simplexes
- Up to two voice/data ports
- 12' 15-Amp cord
- Voice/Data Adapter Kit p/n BE01421 to accept couplers & jacks
- UL Listed
- Overall dimensions - 4-7/16" x 8-5/16"
- Optional powered USB-A+C

All electrical components are UL listed.

Tech Node - Cover Open

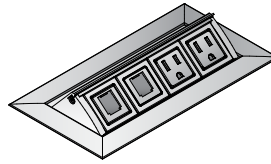

Tech Node - Cover Open with Optional USB-A+C

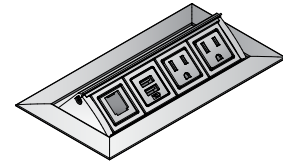

Tech Node - Cover Closed

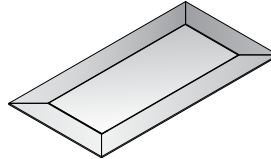

Tech Node - Open Front View

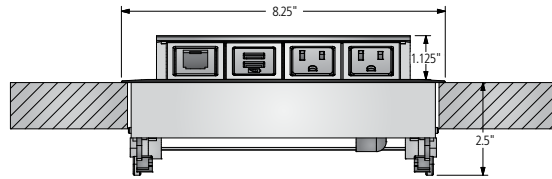

Tech Node - Open Side View

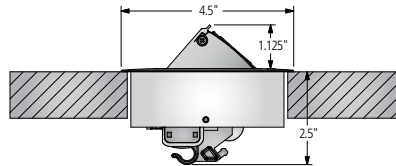

## VOICE/DATA PLANNING

Two (2) simplex voice/data cutouts accept customer supplied, field-installed snap-in connectors.

Nucraft recommends consulting an audio/visual (AV) integrator for assistance with voice/data planning.

## Voice/Data Product Manufacturers

Manufacturer	Phone Number	Web Site
AMP	1-800-522-6752	<a href="http://www.tycoelectronics.com">www.tycoelectronics.com</a>
Avaya	1-866-462-8292	<a href="http://www.avaya.com">www.avaya.com</a>
Leviton	1-800-722-2082	<a href="http://www.leviton.com">www.leviton.com</a>
Panduit	1-800-777-3300	<a href="http://www.panduit.com">www.panduit.com</a>
Siemon	1-860-945-4200	<a href="http://www.siemon.com">www.siemon.com</a>

## LOCATION CODES

TECH NODE	LOCATION	QUANTITY OF UNITS TO ORDER
TN-1	One at center	1
TN-2	One at each end	2
TN-3	One at center and one at each end	3
TN-4	Four equally spaced	4

# TABLE TOP POWER OPTION: TECH NODE

## TECH NODE LOCATION OPTIONS

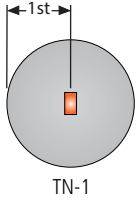

TN-1  
 \*Not available with the Metal X-Base (-XB) or the Cone Base (-PCN or -VCN) on tables less than 60"

TN-1	
Length	Center of Tech Node
36	18
42	21
48	24
54	27
60	30

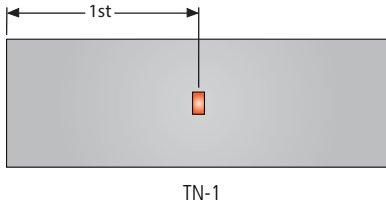

TN-1	
Length	Center of Tech Node
72	36
84	42
90	45
96	48
102	51
108	54
114	57
120	60

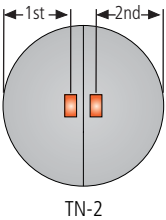

TN-2  
 \*Not available with the Metal X-Base (-XB) or the Cone Base (-PCN or -VCN) on 72" tables

TN-2		
Diameter	Center of 1st Tech Node	Center of 2nd Tech Node
66	27	27
72	30.5	30.5
84	35	35

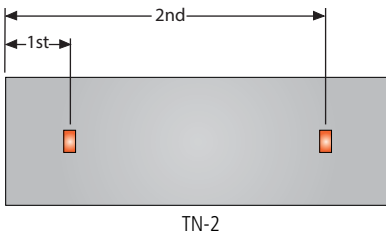

TN-2		
Length	Center of 1st Tech Node	Center of 2nd Tech Node
72	26	46
78	26	52
84	26	58
90	26	64
96	26	70
102	26	76
108	26	82
114	26	88
120	26	94
132	26	106
144	26	118
156	26	130
168	26	142
180	26	154
192	26	166
204	26	178
216	26	190
228	26	202
240	26	214





# TABLE TOP POWER OPTION: TECH NODE

## TECH NODE LOCATION OPTIONS

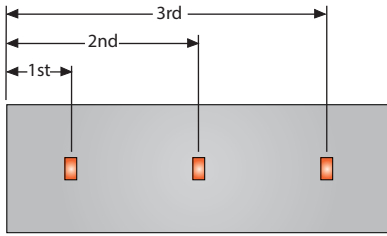

TN-3

TN-3			
Length	Center of 1st Tech Node	Center of 2nd Tech Node	Center of 3rd Tech Node
96	26	48	70
102	26	51	76
108	26	54	82
114	26	57	88
120	26	60	94

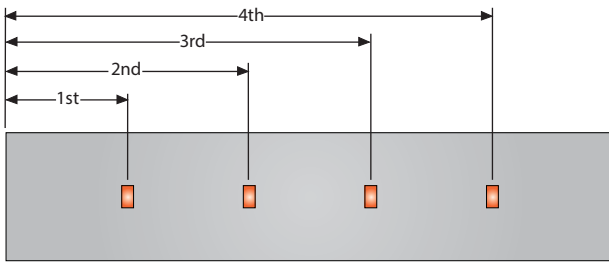

TN-4

TN-4				
Length	Center of 1st Tech Node	Center of 2nd Tech Node	Center of 3rd Tech Node	Center of 4th Tech Node
132	26	53	79	106
144	26	57	87	118
156	26	61	95	130
168	26	65	103	142
180	26	69	111	154
192	26	73	119	166
204	26	77	127	178
216	26	81	135	190
228	26	85	143	202
240	26	89	151	214



## TABLE TOP POWER OPTION: POWER SPEC AND USB SPEC

This compact unit allows for the addition of power or data to a work surface in a discreet way. Available in round or square shapes, and multiple finish options.

### Power Spec

- Spill-proof power simplex
- Compact design
- 1-3/4" cutout for installation
- UL Listed

Power Spec

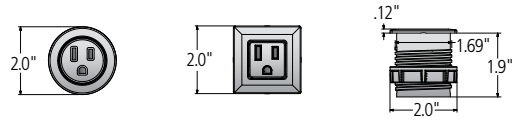

### USB Spec

- Used to charge devices or transfer data
- Compact design
- Offered with USB-A+C
- 1-3/4" cutout
- UL Listed

USB Spec

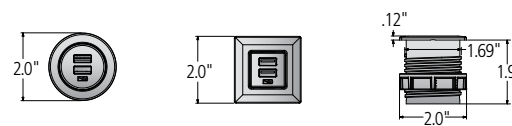



# UNDER SURFACE POWER OPTION: PERIMETER POWER

Perimeter Power provides enhanced power and communication connectivity for each individual seated at a conference table. Attached to the table's apron, Perimeter Power maintains a clean aesthetic on the table top.

Perimeter Power components:

- Hardwire power in-feed (6')
- Duplex receptacles
- NEMA size single-gang cutouts (voice/data)
- Single-gang wallplate cover (blank)
- 20 AMP system

The hardwire power in-feed has a modular connector on one end; the connector attaches to the back side of any power block mounted on the table's apron. This feature allows total flexibility in determining floor monument location under any table base. All tables ship pre-wired.

Note: Clearance from the floor to the bottom of the apron is 24-3/4". Apron is recessed 2-1/8" under the table.

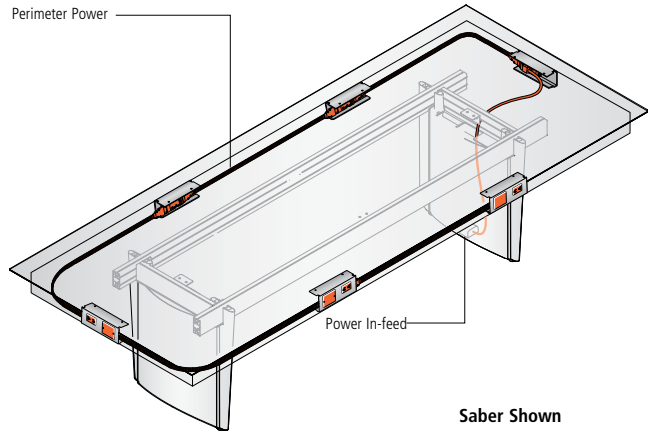

Saber Shown

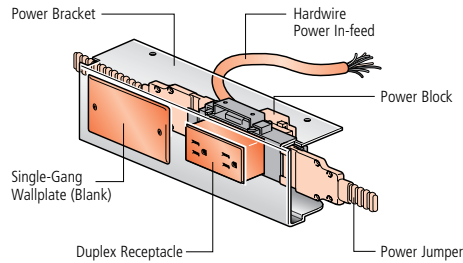

## POWER AND VOICE/DATA CAPABILITIES

Refer to the individual product sections for specific Perimeter Power application guidelines.

Not available with round tops.

Perimeter Power Configuration with Two Piece Top with Three Bases (Plan View)

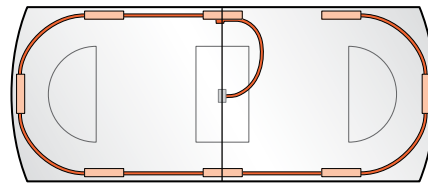

Fortè® Shown

TABLE LENGTH	TOTAL POWER BRACKETS	BRACKETS PER SIDE	BRACKETS PER END	SIMPLEX RECEPTACLES	CIRCUITS	SINGLE-GANG CUTOUTS
96	6	2	1	12	1	6
120	6	2	1	12	1	6
144	8	3	1	16	2	8
168	8	3	1	16	2	8
192	8	3	1	16	2	8
216	10	4	1	20	2	10
240	10	4	1	20	2	10

## PERIMETER POWER BRACKET DIMENSIONS

Front Elevation View

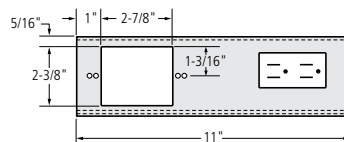

End Elevation View

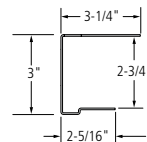

# UNDER SURFACE POWER OPTION: PERIMETER POWER

## POWER PLANNING

### Perimeter Power Electrical System

- 8-wire, 4-circuit modular electrical system
- All tables are pre-wired
- Hardwire power in-feed only. A licensed electrician is required to complete hardwire connections to building's power source.
- Neutral (white) wires are 10 gauge, hot and ground wires are 12 gauge.
- All electrical components satisfy National Electrical Code (NEC) requirements and are UL listed

### Electrical Diagram — Hardwire Power Infeed Only

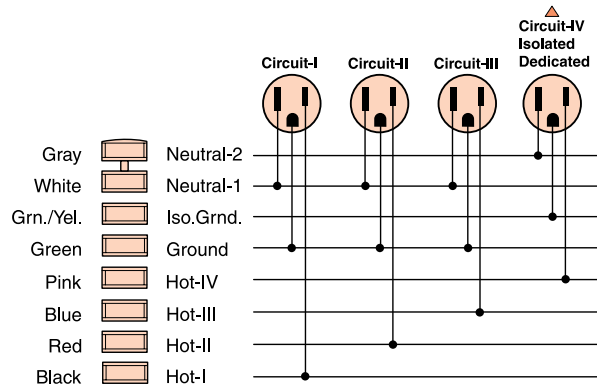

Four circuits, one isolated. This electrical schematic can be used with three-phase or single-phase power.

### Field-Wired Electrical Requirements

Some local electrical codes may require field-wiring during installation. In such instances, a Field-Wired option may be specified. In this configuration, Perimeter Power includes power junction boxes instead of the standard modular electrical system. Specific electrical components such as receptacles must be furnished separately.

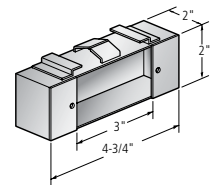

## VOICE/DATA PLANNING

The Perimeter Power assembly does not include any factory-installed voice/data components. It does include one (1) NEMA size cutout per bracket with a blank wall-plate cover.

Faceplates and data connectors must be purchased and installed in the field.

### Cutout Opening Dimensions

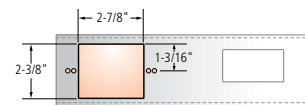

### Voice/Data Product Manufacturers

Nucraft recommends consulting an audio/visual (AV) integrator for assistance with voice/data planning.

Manufacturer	Phone Number	Web Site
AMP	1-800-522-6752	<a href="http://www.tycoelectronics.com">www.tycoelectronics.com</a>
Avaya	1-866-462-8292	<a href="http://www.avaya.com">www.avaya.com</a>
Leviton	1-800-722-2082	<a href="http://www.leviton.com">www.leviton.com</a>
Panduit	1-800-777-3300	<a href="http://www.panduit.com">www.panduit.com</a>
Siemon	1-860-945-4200	<a href="http://www.siemon.com">www.siemon.com</a>



# UNDER SURFACE POWER OPTION: POWER RAIL

This low-profile option addresses the need for power & data connectivity just below the table top. This is an ideal choice for those who desire a visually uninterrupted table top and appreciate the inherent flexibility of the Power Rail to be removed at a later date as they transition to a truly wireless environment.

Held in place with screws, Power Rail units can be placed anywhere along the perimeter of the table. This flexible mounting design allows for additional units to be added as necessary, or to be removed when no longer needed.

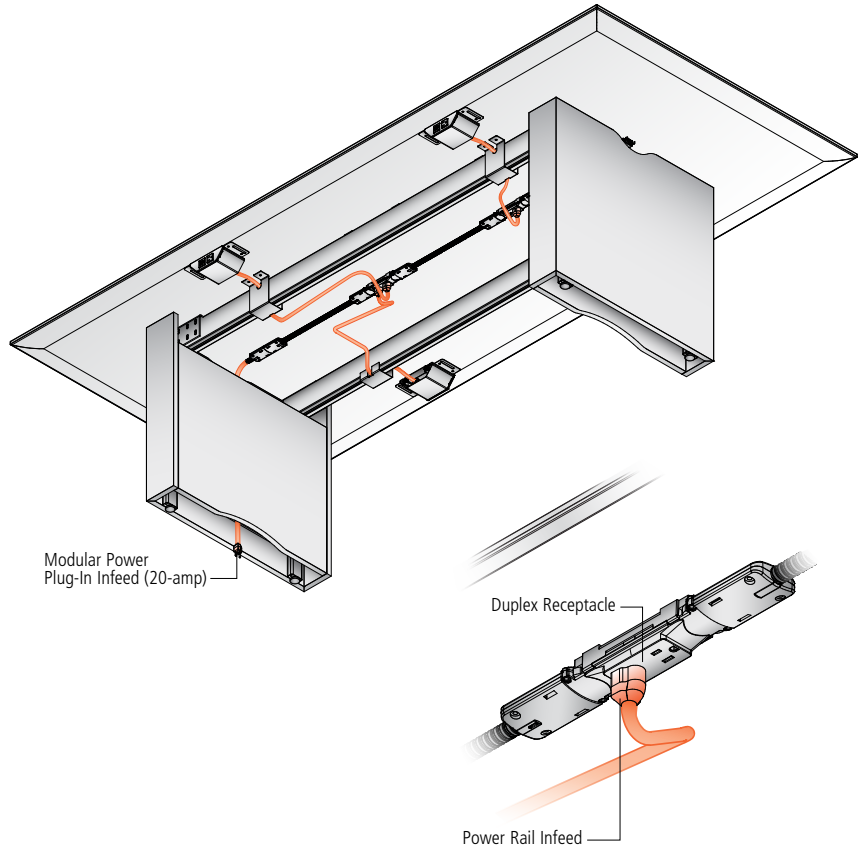

Power Rails are available in three configurations:

- Two simplex receptacles (UL Listed)
- One simplex receptacle and one powered USB-A+C connector (UL Listed)
- Two single space A/V faceplate designed for use with Extron Architectural Adaptor Plates (AAPs)

When Power Rails are specified on a Flow table, a direct plug-in infeed or hardwired option is available. The direct plug-in infeed option has a single circuit electrical system and the hardwire option requires a two-circuit electrical system. Maximum of 12 Power Rails per table

**Front Elevation**

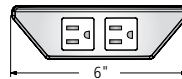

**Side Elevation**

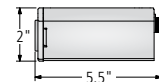



# UNDER SURFACE POWER OPTION: CHARGING TRAC

Charging Trac is a low voltage, under surface power system with 2 USB ports per unit. It's modular configuration provides a customizable solution. Offered in a 2 or 4 unit kit of parts with a plug-in infeed. USB-A compatible.

## Charging Trac Wire Management (Flow table with rectangle bases shown)

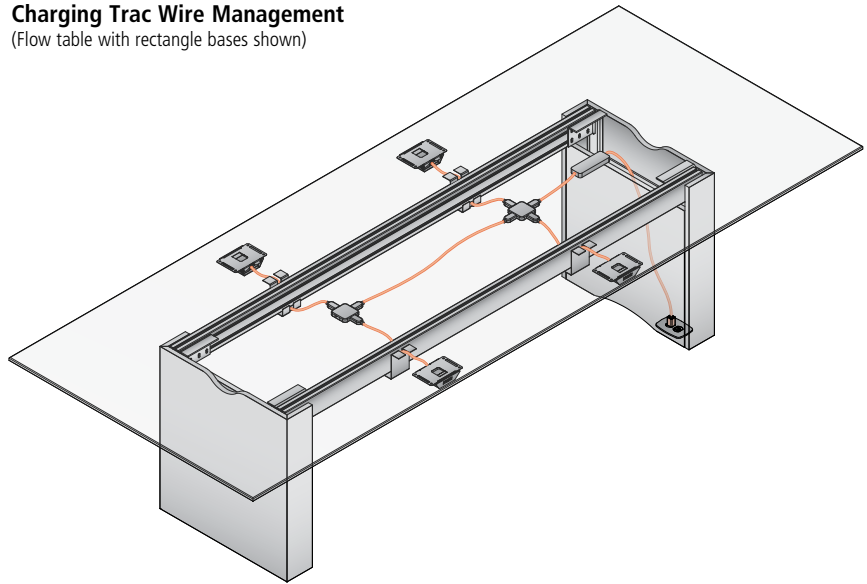

Front Elevation

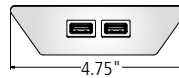

Side Elevation

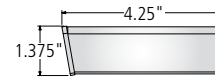

### Two-Unit Configuration includes:

- 2 Brackets, each bracket offers 2 USB-A ports
- 1 Puck
- 1 Plug-in infeed

### Two-Unit Configuration

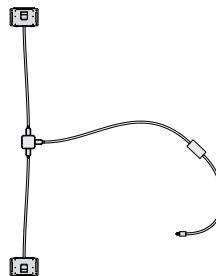

### Four-Unit Configuration includes:

- 4 Brackets, each bracket offers 2 USB-A ports
- 2 Pucks
- Jumpers
- 1 Plug-in infeed

### Four-Unit Configuration

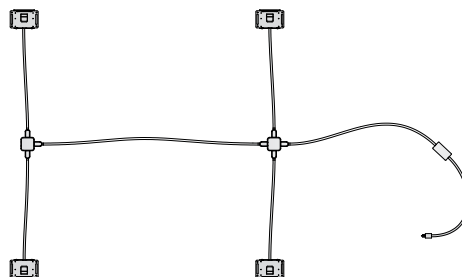



# FREESTANDING POWER OPTION: TECH ZONE

## TECH ZONE

Simple, easy to use and portable, this freestanding table top power option allows you to easily charge all of your devices.

Available in two configurations with a variety of power and data connectivity options. Includes a 72"-long plug-in infeed cord.

### ZONE-USB-C

Includes two simplex receptacles, one data port and one charging USB-A+C charging port

### ZONE-DATA

Includes two simplex receptacles and two open data ports

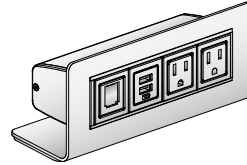

Tech Zone - Side View

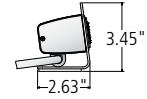

ZONE-USB-C

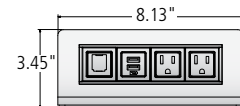

ZONE-DATA



# WIRE MANAGEMENT OPENINGS

## Panel Base - End

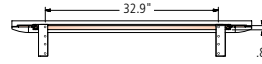
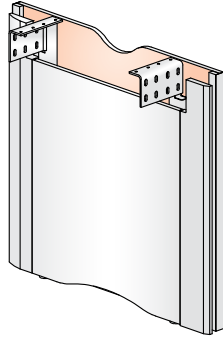

Rectangle & Boat - 72" Wide Tops  
Sight Line - 76" & 78" Wide Ends

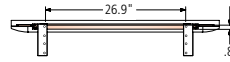

Rectangle - 66" Wide Tops  
Sight Line - 70" & 72" Wide Ends

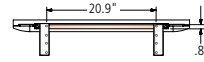

Rectangle & Boat - 60" Wide Tops  
Sight Line - 66" & 68" Wide Ends

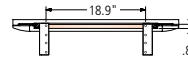

Rectangle & Boat - 54" Wide Tops  
Sight Line - 60" Wide Ends

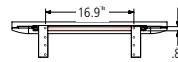

Rectangle - 42" & 48" Wide Tops  
Boat - 40", 44", 48" & 50" Wide Tops  
Sight Line - All Narrow Ends and  
54", 56" and 58" Wide Ends

## Panel Base - Center

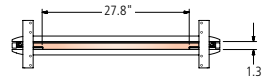
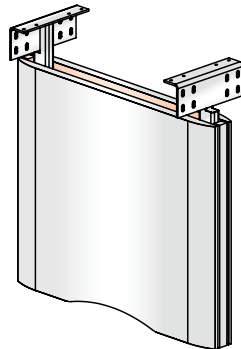

Rectangle & Boat - 72" Wide Tops  
Sight Line - 76" & 78" Wide Ends

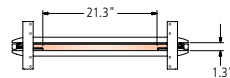

Rectangle - 66" Wide Tops  
Sight Line - 70" & 72" Wide Ends

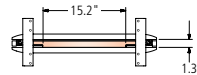

Rectangle & Boat - 60" Wide Tops  
Sight Line - 66" & 68" Wide Ends

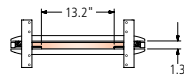

Rectangle & Boat - 54" Wide Tops  
Sight Line - 60" Wide Ends

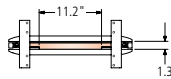

Rectangle - 48" Wide Tops  
Boat - 40", 44", 48" & 50" Wide Tops  
Sight Line - All Narrow Ends and  
54", 56" and 58" Wide Ends



# WIRE MANAGEMENT OPENINGS

## Four Post Base, T-Base and Hoop Base (Non-Structural Support Center Column)

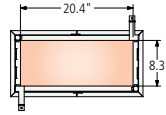
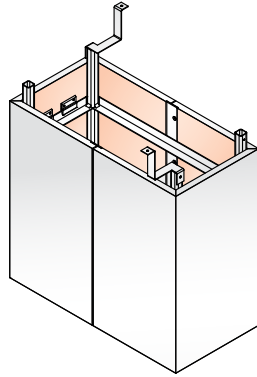

All Tables Up to 144"

## Four Post Base, T-Base and Hoop Base (Structural Support Center Column)

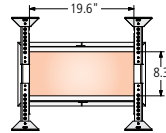
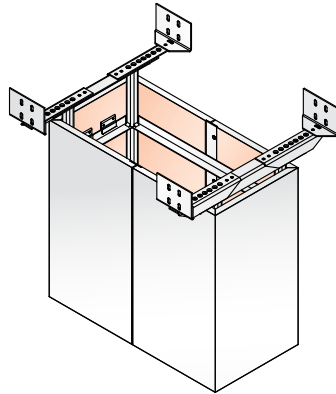

Tables 156" and Larger

## Rectangle Base (all table materials, except Stone)

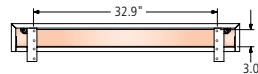
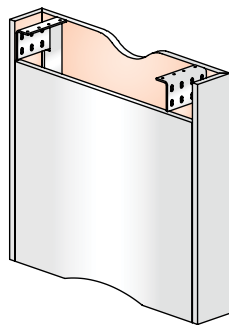

Rectangle & Boat - 72" Wide Tops  
Sight Line - 76" & 78" Wide Ends

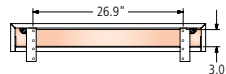

Rectangle - 66" Wide Tops  
Sight Line - 70" & 72" Wide Ends

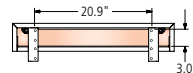

Rectangle & Boat - 60" Wide Tops  
Sight Line - 66" & 68" Wide Ends

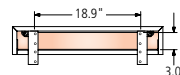

Rectangle & Boat - 54" Wide Tops  
Sight Line - 60" Wide Ends

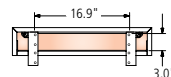

Rectangle - 42" & 48" Wide Tops  
Boat - 40", 44", 48" & 50" Wide Tops  
Sight Line - All Narrow Ends and  
54", 56" and 58" Wide Ends

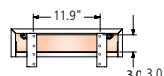

Rectangle - 36" Wide Tops



# WIRE MANAGEMENT OPENINGS

## Rectangle Base (Stone tables only)

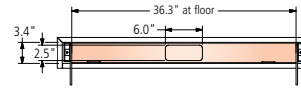
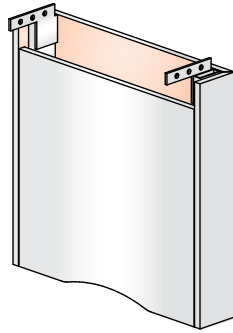

Boat - 72" Wide Tops  
Sight Line - 76" & 78" Wide Ends

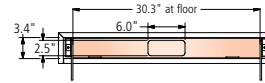

Sight Line - 70" & 72" Wide Ends

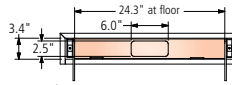

Rectangle & Boat - 60" Wide Tops  
Sight Line - 66" & 68" Wide Ends

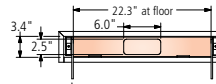

Rectangle & Boat - 54" Wide Tops  
Sight Line - 60" Wide Ends

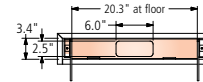

Rectangle - 42" & 48" Wide Tops  
Boat - 40", 44", 48" & 50" Wide Tops  
Sight Line - All Narrow Ends and  
54", 56" and 58" Wide Ends

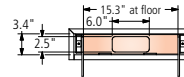

Rectangle - 36" Wide Tops



# WIRE MANAGEMENT OPENINGS

## Expandable Rectangle Base - End

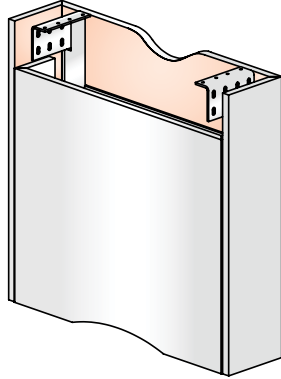

Expandable Rectangle End Bases feature an adjustable inside panel that can be set at one of three positions as shown below.

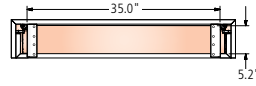
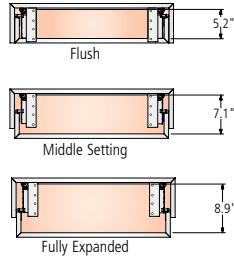

Rectangle & Boat - 72" Wide Tops  
Sight Line - 76" & 78" Wide Ends

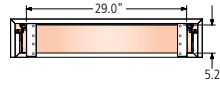

Rectangle - 66" Wide Tops  
Sight Line - 70" & 72" Wide Ends

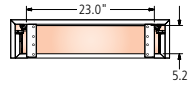

Rectangle & Boat - 60" Wide Tops  
Sight Line - 66" & 68" Wide Ends

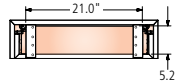

Rectangle & Boat - 54" Wide Tops  
Sight Line - 60" Wide Ends

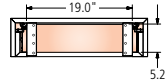

Rectangle - 42" & 48" Wide Tops  
Boat - 40", 44", 48" & 50" Wide Tops  
Sight Line - All Narrow Ends and  
54", 56" and 58" Wide Ends

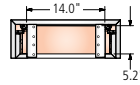

Rectangle - 36" Wide Tops

## Expandable Rectangle Base - Center

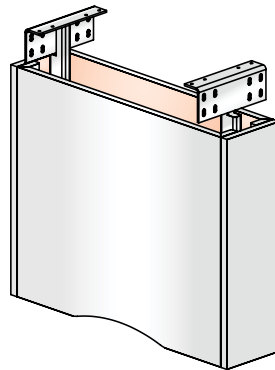

Expandable Rectangle Center Bases feature adjustable panels that can be set at one of two positions as shown below.

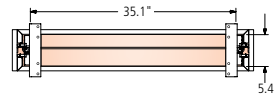
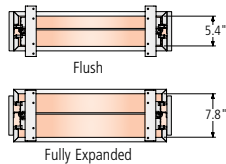

Rectangle & Boat - 72" Wide Tops  
Sight Line - 76" & 78" Wide Ends

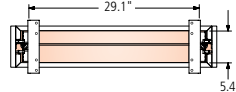

Rectangle - 66" Wide Tops  
Sight Line - 70" & 72" Wide Ends

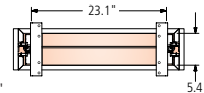

Rectangle & Boat - 60" Wide Tops  
Sight Line - 66" & 68" Wide Ends

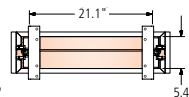

Rectangle & Boat - 54" Wide Tops  
Sight Line - 60" Wide Ends

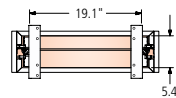

Rectangle - 42" & 48" Wide Tops  
Boat - 40", 44", 48" & 50" Wide Tops  
Sight Line - All Narrow Ends and  
54", 56" and 58" Wide Ends



# WIRE MANAGEMENT OPENINGS

## Column Base - End and Center Bases (Available on stone top tables only)

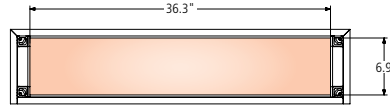
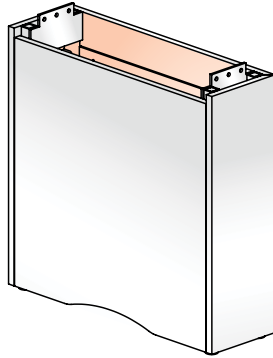

Boat - 72" Wide Tops  
Sight Line - 76" & 78" Wide Ends

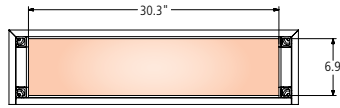

Sight Line - 70" & 72" Wide Ends

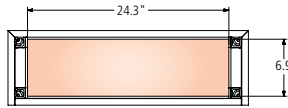

Rectangle & Boat - 60" Wide Tops  
Sight Line - 66" & 68" Wide Ends

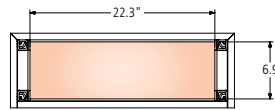

Rectangle & Boat - 54" Wide Tops  
Sight Line - 60" Wide Ends

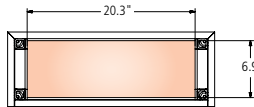

Rectangle - 42" & 48" Wide Tops  
Boat - 40", 44", 48" & 50" Wide Tops  
Sight Line - All Narrow Ends and  
54", 56" and 58" Wide Ends

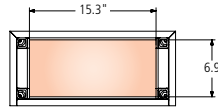

Rectangle - 36" Wide Tops

## Cylinder Base

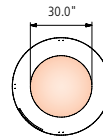
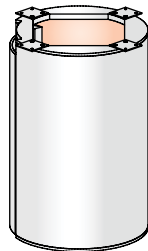

84" Diameter Tops

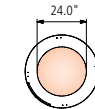

72" Diameter Tops



66" Diameter Tops



60" Diameter Tops



54" Diameter Tops



36", 42" & 48" Diameter Tops



# WIRE MANAGEMENT OPENINGS

## Cone Base

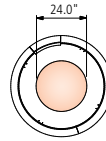
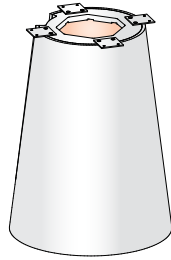

84" Diameter Tops

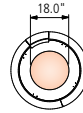

72" Diameter Tops



66" Diameter Tops



60" Diameter Tops



54" Diameter Tops



36", 42" & 48" Diameter Tops

## T-Base

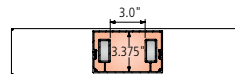

T-Base wire management opening is the same for all Rectangle, Boat & Sight Line tables, regardless of top size

## Hoop Base with Wire Manager

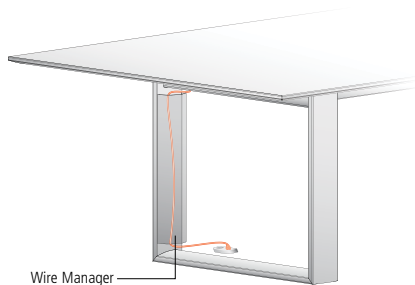

Wire Manager

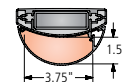

Hoop Base Wire Manager dimensions are the same for all Rectangle, Boat & Sight Line tables, regardless of top size.

Wire Manager attaches to inside of Hoop Base.

One wire manager included with the Hoop Base table (regardless of table size).



# WIRE MANAGEMENT OPENINGS

Island Base

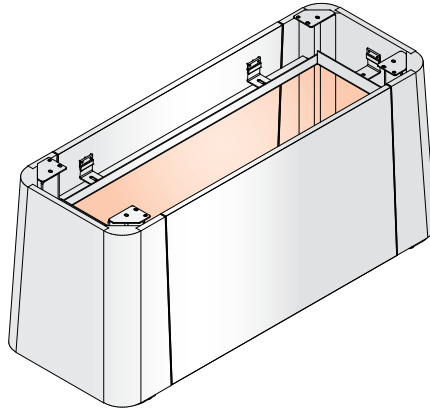

Top Width	A
54	10.7
60	14.2
66	16.2
72	22.2

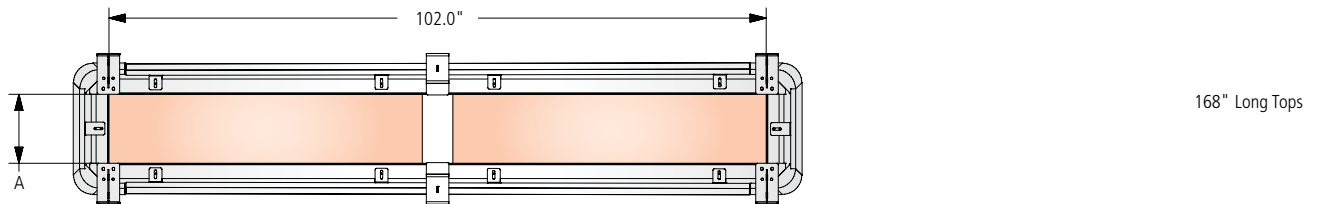
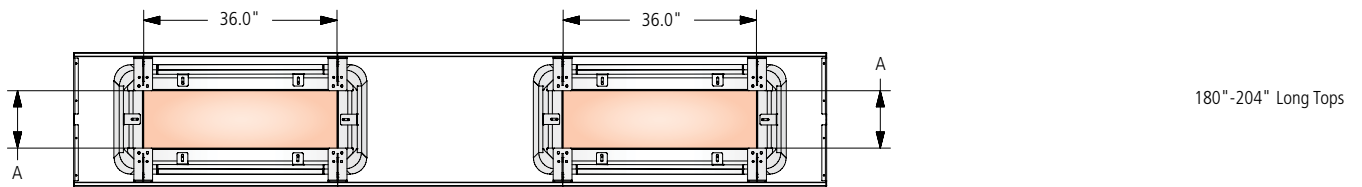
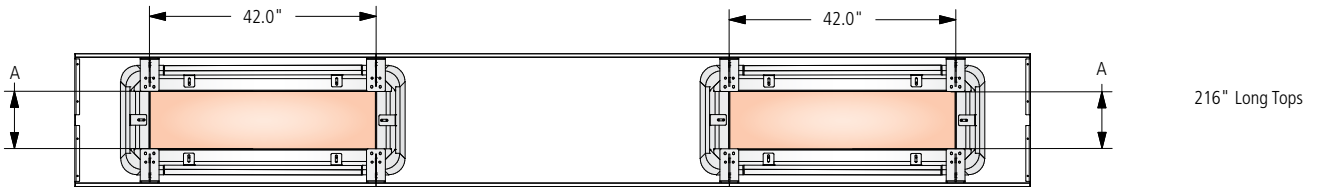
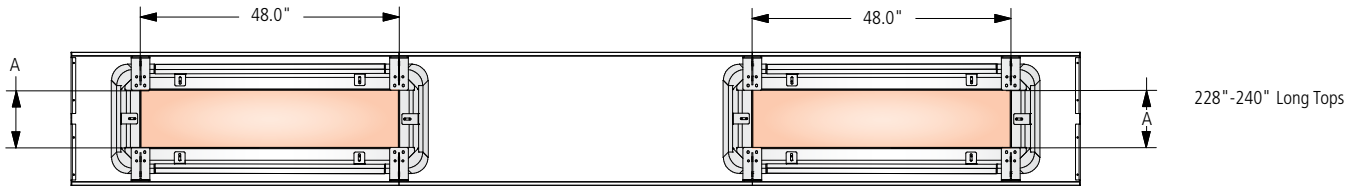



# WIRE MANAGEMENT OPENINGS

## Island Base

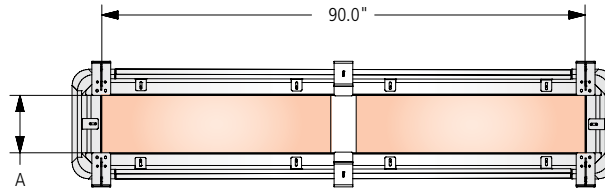

156" Long Tops

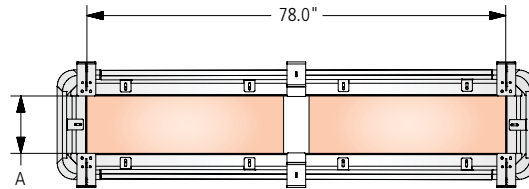

144" Long Tops

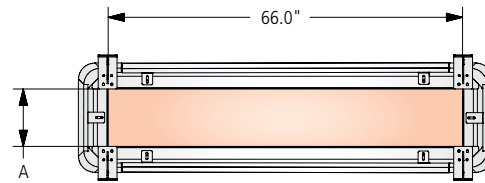

132" Long Tops

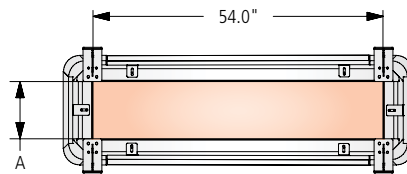

120" Long Tops

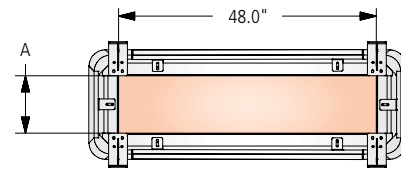

114" Long Tops

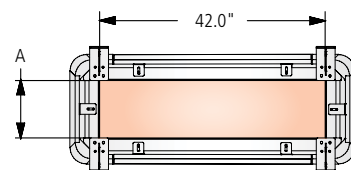

108" Long Tops



# BASE DIMENSIONS

## Panel Base - End

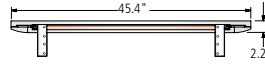
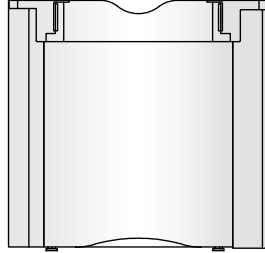

Rectangle & Boat - 72" Wide Tops  
Sight Line - 76" & 78" Wide Ends

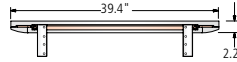

Rectangle - 66" Wide Tops  
Sight Line - 70" & 72" Wide Ends

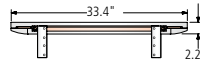

Rectangle & Boat - 60" Wide Tops  
Sight Line - 66" & 68" Wide Ends

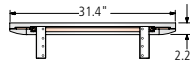

Rectangle & Boat - 54" Wide Tops  
Sight Line - 60" Wide Ends

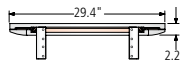

Rectangle - 42" & 48" Wide Tops  
Boat - 40", 44", 48" & 50" Wide Tops  
Sight Line - All Narrow Ends and  
54", 56" and 58" Wide Ends

## Panel Base - Center

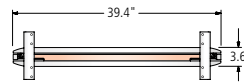
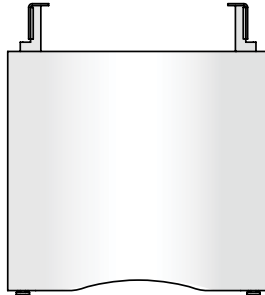

Rectangle & Boat - 72" Wide Tops  
Sight Line - 76" & 78" Wide Ends

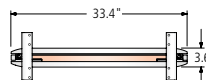

Rectangle - 66" Wide Tops  
Sight Line - 70" & 72" Wide Ends

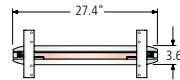

Rectangle & Boat - 60" Wide Tops  
Sight Line - 66" & 68" Wide Ends

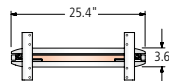

Rectangle & Boat - 54" Wide Tops  
Sight Line - 60" Wide Ends

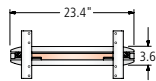

Rectangle - 48" Wide Tops  
Boat - 40", 44", 48" & 50" Wide Tops  
Sight Line - All Narrow Ends and  
54", 56" and 58" Wide Ends





# BASE DIMENSIONS

## Four Post Base, T-Base and Hoop Base (Non-Structural Support Center Column)

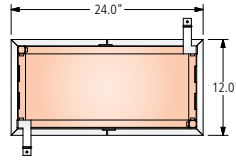
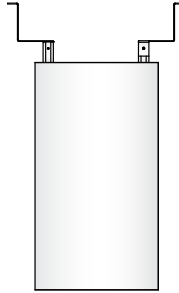

All Tables Up to 144"

## Four Post Base, T-Base and Hoop Base (Structural Support Center Column)

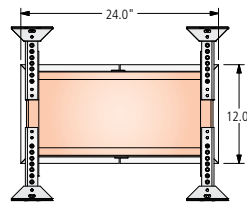
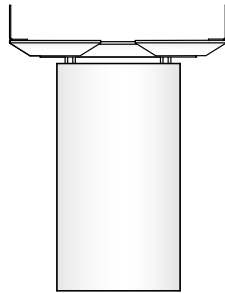

Tables 156" and Larger



# BASE DIMENSIONS

## Rectangle Base (All top materials except Stone)

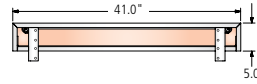
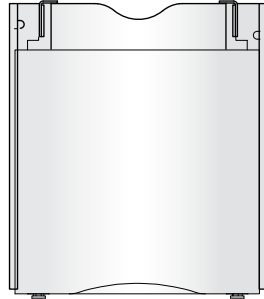

Rectangle & Boat - 72" Wide Tops  
Sight Line - 76" & 78" Wide Ends

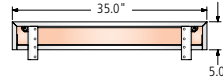

Rectangle - 66" Wide Tops  
Sight Line - 70" & 72" Wide Ends

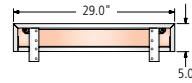

Rectangle & Boat - 60" Wide Tops  
Sight Line - 66" & 68" Wide Ends

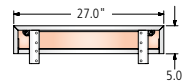

Rectangle & Boat - 54" Wide Tops  
Sight Line - 60" Wide Ends

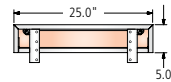

Rectangle - 42" & 48" Wide Tops  
Boat - 40", 44", 48" & 50" Wide Tops  
Sight Line - All Narrow Ends and  
54", 56" and 58" Wide Ends

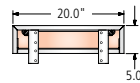

Rectangle - 36" Wide Tops

## Rectangle Base (Stone tables only)

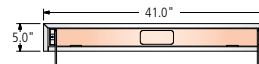
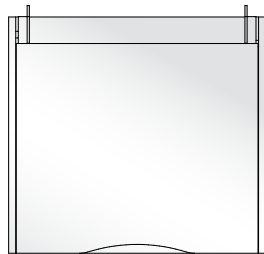

Boat - 72" Wide Tops  
Sight Line - 76" & 78" Wide Ends

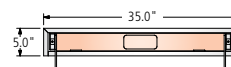

Sight Line - 70" & 72" Wide Ends

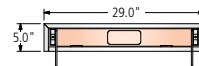

Rectangle & Boat - 60" Wide Tops  
Sight Line - 66" & 68" Wide Ends

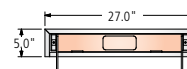

Rectangle & Boat - 54" Wide Tops  
Sight Line - 60" Wide Ends

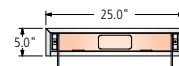

Rectangle - 42" & 48" Wide Tops  
Boat - 40", 44", 48" & 50" Wide Tops  
Sight Line - All Narrow Ends and  
54", 56" and 58" Wide Ends

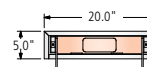

Rectangle - 36" Wide Tops



# BASE DIMENSIONS

## Expandable Rectangle Base - End

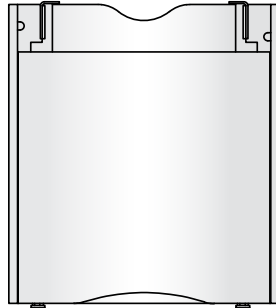

Expandable Rectangle End Bases feature an adjustable inside panel that can be set at one of three positions as shown below.

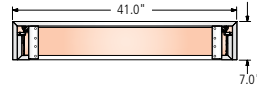
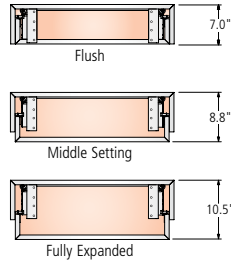

Rectangle & Boat - 72" Wide Tops  
Sight Line - 76" & 78" Wide Ends

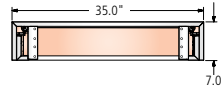

Rectangle - 66" Wide Tops  
Sight Line - 70" & 72" Wide Ends

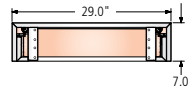

Rectangle & Boat - 60" Wide Tops  
Sight Line - 66" & 68" Wide Ends

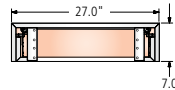

Rectangle & Boat - 54" Wide Tops  
Sight Line - 60" Wide Ends

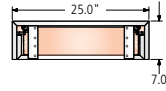

Rectangle - 42" & 48" Wide Tops  
Boat - 40", 44", 48" & 50" Wide Tops  
Sight Line - All Narrow Ends and  
54", 56" and 58" Wide Ends

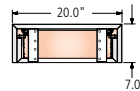

Rectangle - 36" Wide Tops

## Expandable Rectangle Base - Center

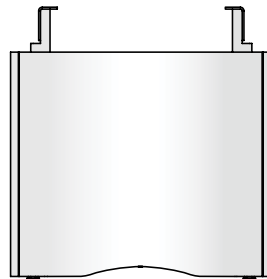

Expandable Rectangle Center Bases feature adjustable panels that can be set at one of two positions as shown below.

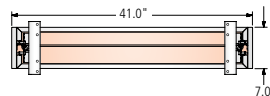
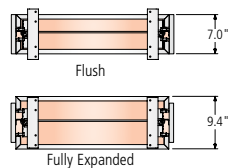

Rectangle & Boat - 72" Wide Tops  
Sight Line - 76" & 78" Wide Ends

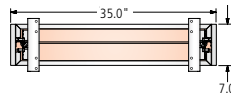

Rectangle - 66" Wide Tops  
Sight Line - 70" & 72" Wide Ends

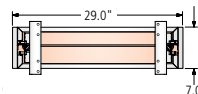

Rectangle & Boat - 60" Wide Tops  
Sight Line - 66" & 68" Wide Ends

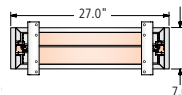

Rectangle & Boat - 54" Wide Tops  
Sight Line - 60" Wide Ends

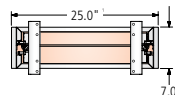

Rectangle - 42" & 48" Wide Tops  
Boat - 40", 44", 48" & 50" Wide Tops  
Sight Line - All Narrow Ends and  
54", 56" and 58" Wide Ends



# BASE DIMENSIONS

## Column Base - End and Center Bases (Available on stone top tables only)

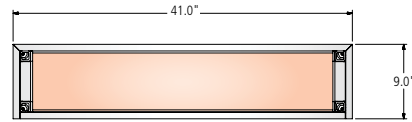
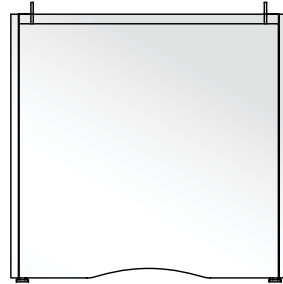

Boat - 72" Wide Tops  
Sight Line - 76" & 78" Wide Ends

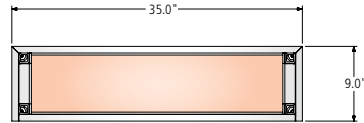

Sight Line - 70" & 72" Wide Ends

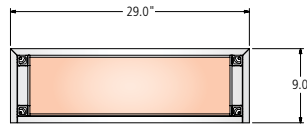

Rectangle & Boat - 60" Wide Tops  
Sight Line - 66" & 68" Wide Ends

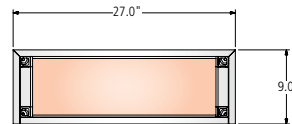

Rectangle & Boat - 54" Wide Tops  
Sight Line - 60" Wide Ends

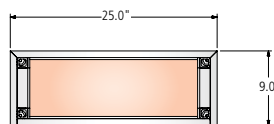

Rectangle - 42" & 48" Wide Tops  
Boat - 40", 44", 48" & 50" Wide Tops  
Sight Line - All Narrow Ends and  
54", 56" and 58" Wide Ends

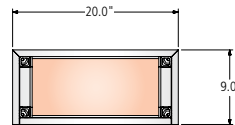

Rectangle - 36" Wide Tops

## T-Base

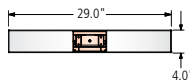
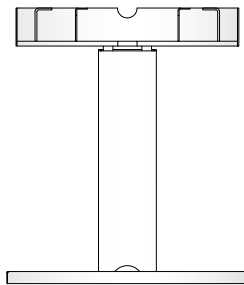

Rectangle & Boat - 60" Wide Tops  
Sight Line - 66" & 68" Wide Ends

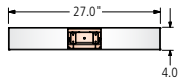

Rectangle & Boat - 54" Wide Tops  
Sight Line - 60" Wide Ends

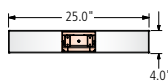

Rectangle - 42" & 48" Wide Tops  
Boat - 40", 44", 48" & 50" Wide Tops  
Sight Line - All Narrow Ends and  
54", 56" and 58" Wide Ends

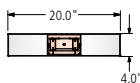

Rectangle - 36" Wide Tops



# BASE DIMENSIONS

## Cylinder Base

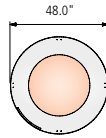
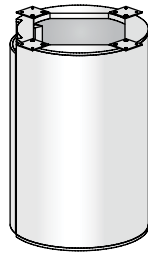

84" Diameter Tops

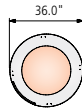

72" Diameter Tops



66" Diameter Tops



60" Diameter Tops



54" Diameter Tops



36", 42" & 48" Diameter Tops

## Hoop Base (All top materials except Stone)

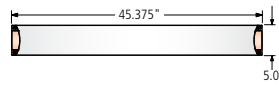
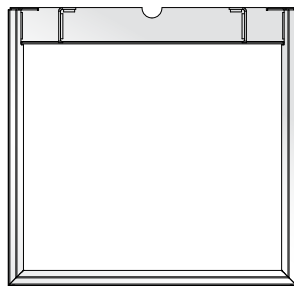

Rectangle & Boat - 72" Wide Tops  
Sight Line - 76" & 78" Wide Ends

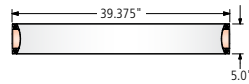

Rectangle - 66" Wide Tops  
Sight Line - 70" & 72" Wide Ends

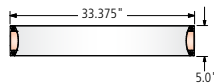

Rectangle & Boat - 60" Wide Tops  
Sight Line - 66" & 68" Wide Ends

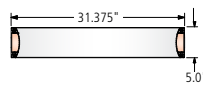

Rectangle & Boat - 54" Wide Tops  
Sight Line - 60" Wide Ends

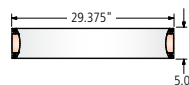

Rectangle - 48" Wide Tops  
Boat - 40", 44", 48" & 50" Wide Tops  
Sight Line - All Narrow Ends and  
54", 56" and 58" Wide Ends



# BASE DIMENSIONS

## Hoop Base (Stone tables only)

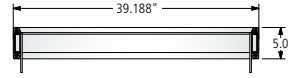
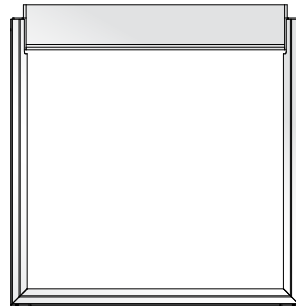

Boat - 72" Wide Tops  
Sight Line - 76" & 78" Wide Ends

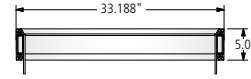

Sight Line - 70" & 72" Wide Ends

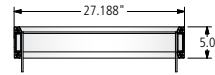

Rectangle & Boat - 60" Wide Tops  
Sight Line - 66" & 68" Wide Ends

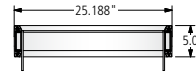

Rectangle & Boat - 54" Wide Tops  
Sight Line - 60" Wide Ends

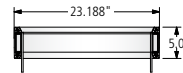

Rectangle - 48" Wide Tops  
Boat - 40", 44", 48" & 50" Wide Tops  
Sight Line - All Narrow Ends and  
54", 56" and 58" Wide Ends

## Cone Base

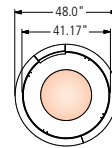
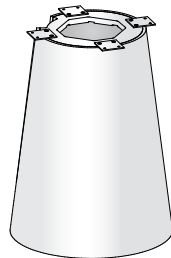

84" Diameter Tops

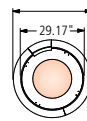

72" Diameter Tops

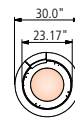

66" Diameter Tops

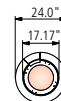

60" Diameter Tops



54" Diameter Tops



36", 42" & 48" Diameter Tops



# BASE DIMENSIONS

## Metal X-Base

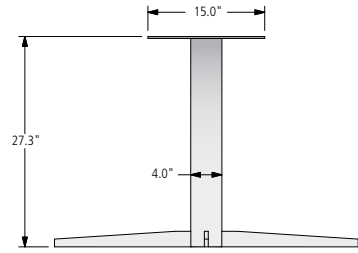

60" Diameter Tops

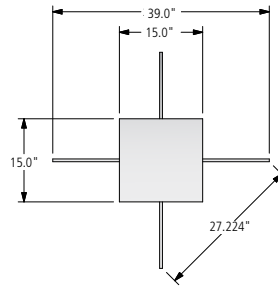

60" Diameter Tops

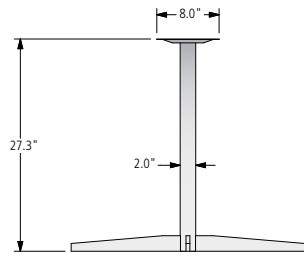

36", 42", 48" & 54" Diameter Tops

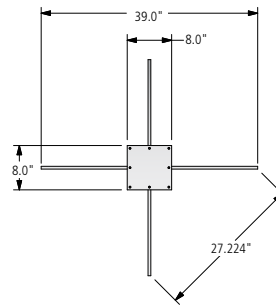

48" & 54" Diameter Tops

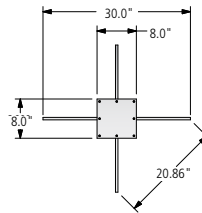

36" & 42" Diameter Tops



# BASE DIMENSIONS

## Café Height Base

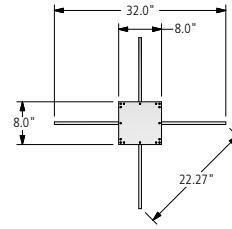
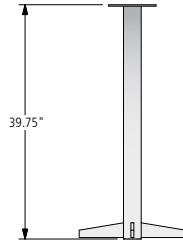

39" & 42" Diameter Tops

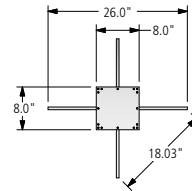

33" & 36" Diameter Tops

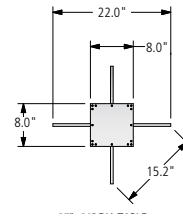

27" & 30" Diameter Tops

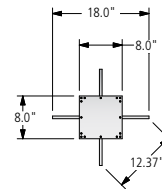

24" Diameter Tops





# BASE DIMENSIONS

Island Base

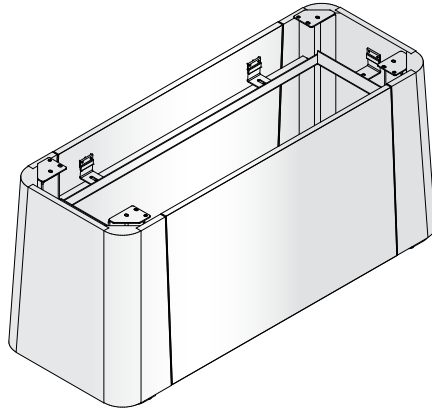

Top Width	A
54	20.5
60	24.0
66	26.0
72	32.2

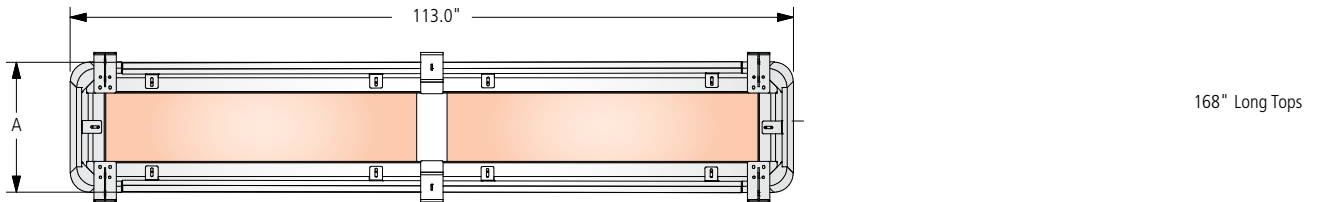
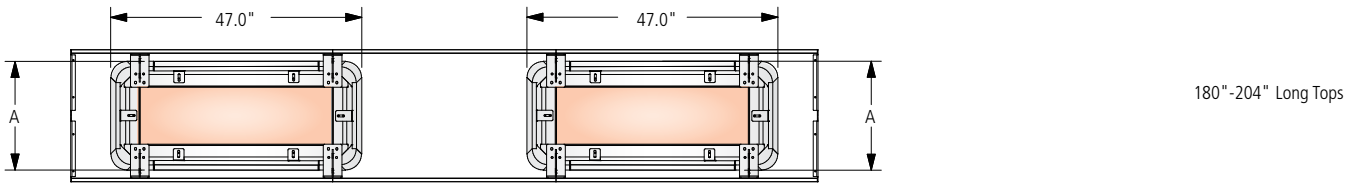
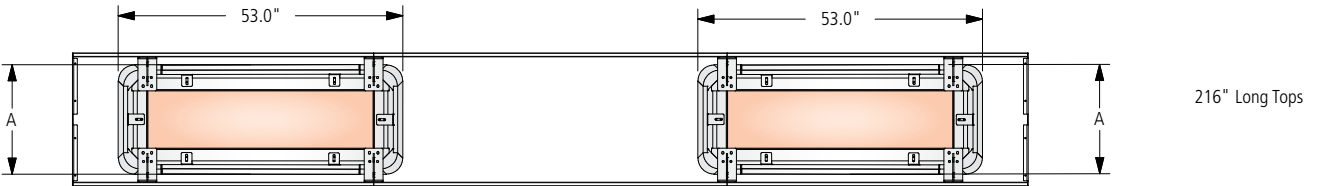
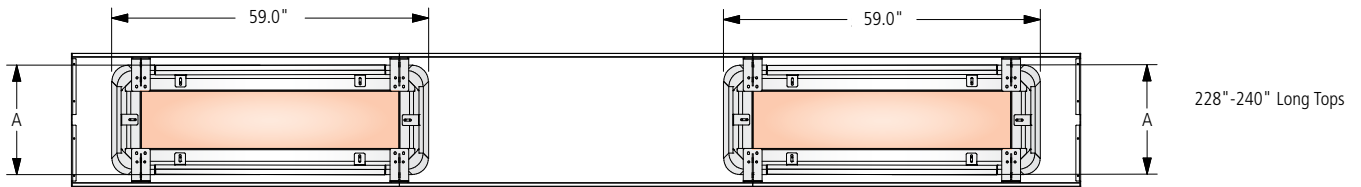

# BASE DIMENSIONS

## Island Base

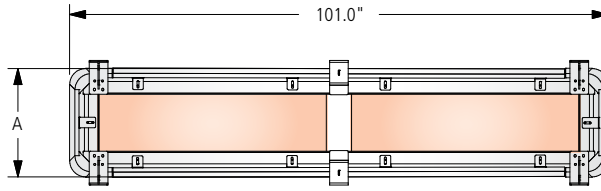

156" Wide Tops

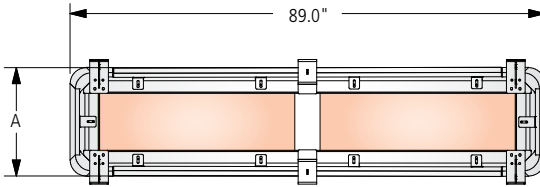

144" Wide Tops

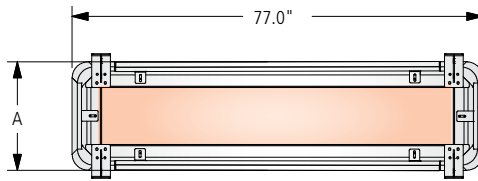

132" Wide Tops

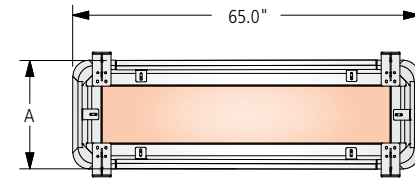

120" Wide Tops

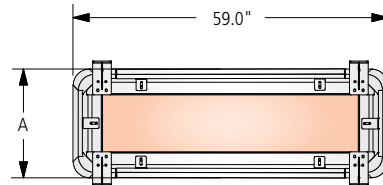

114" Wide Tops

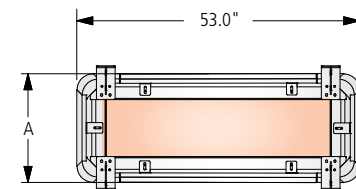

108" Wide Tops



# BASE LOCATIONS

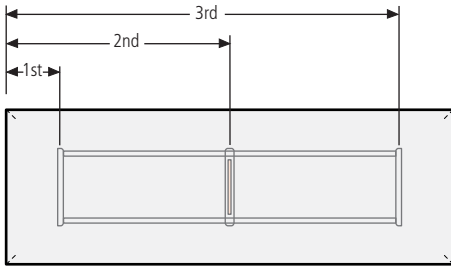

### PANEL BASE (ALL TABLE SHAPES)

Table Length	Center of 1st Base	Center of 2nd Base	Center of 3rd Base
72	-	-	-
78	-	-	-
84	19	65	-
90	19	71	-
96	19	77	-
102	19	83	-
108	19	89	-
114	19	95	-
120	19	101	-
132	19	113	-
144	19	125	-
156	19	78	137
168	19	84	149
180	19	90	161
192	19	96	173
204	19	102	185
216	19	108	197
228	19	114	209
240	19	120	221

\*Panel Base will not fit over a floor core.

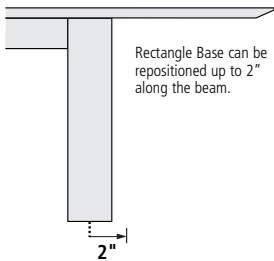
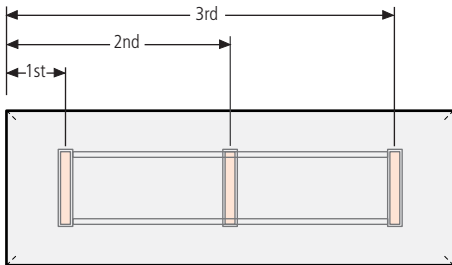

### RECTANGLE BASE (ALL TABLE SHAPES)

Table Length	Center of 1st Base	Center of 2nd Base	Center of 3rd Base
72	20.5	51.5	-
78	20.5	57.5	-
84	20.5	63.5	-
90	20.5	69.5	-
96	20.5	75.5	-
102	20.5	81.5	-
108	20.5	87.5	-
114	20.5	93.5	-
120	20.5	99.5	-
132	20.5	111.5	-
144	20.5	123.5	-
156	20.5	78	135.5
168	20.5	84	147.5
180	20.5	90	159.5
192	20.5	96	171.5
204	20.5	102	183.5
216	20.5	108	195.5
228	20.5	114	207.5
240	20.5	120	219.5

### EXPANDABLE RECTANGLE BASE (CLOSED POSITION / ALL TABLE SHAPES)

Table Length	Center of 1st Base	Center of 2nd Base	Center of 3rd Base
72	21.5	50.5	-
78	21.5	56.5	-
84	21.5	62.5	-
90	21.5	68.5	-
96	21.5	74.5	-
102	21.5	80.5	-
108	21.5	86.5	-
114	21.5	92.5	-
120	21.5	98.5	-
132	21.5	110.5	-
144	21.5	122.5	-
156	21.5	78	134.5
168	21.5	84	146.5
180	21.5	90	158.5
192	21.5	96	170.5
204	21.5	102	182.5
216	21.5	108	194.5
228	21.5	114	206.5
240	21.5	120	218.5

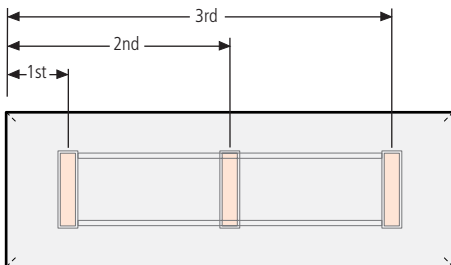



# BASE LOCATIONS

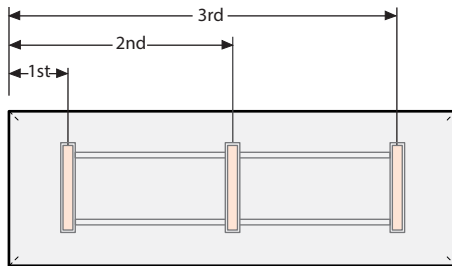
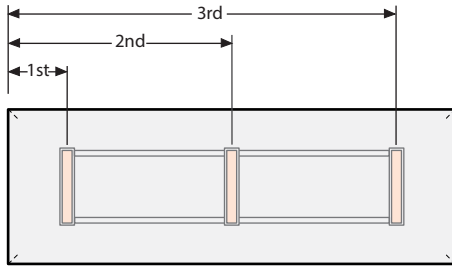

### T-BASE (ALL TABLE SHAPES)

Table Length	Center of 1st Base	Center of 2nd Base	Center of 3rd Base
72	16.5	55.5	-
78	16.5	61.5	-
84	20.5	63.5	-
90	20.5	69.5	-
96	20.5	75.5	-
102	20.5	81.5	-
108	20.5	87.5	-
114	20.5	93.5	-
120	20.5	99.5	-
132	20.5	66	111.5
144	20.5	72	123.5
156	20.5	78	135.5
168	20.5	84	147.5
180	20.5	90	159.5
192	20.5	96	171.5
204	20.5	102	183.5
216	20.5	108	195.5
228	20.5	83.5	144.5
240	20.5	87.5	152.5

### HOOP BASE (ALL TABLE SHAPES)

Table Length	Center of 1st Base	Center of 2nd Base	Center of 3rd Base
72	-	-	-
78	-	-	-
84	20.375	63.625	-
90	20.375	69.625	-
96	20.375	75.625	-
102	20.375	81.625	-
108	20.375	87.625	-
114	20.375	93.625	-
120	20.375	99.625	-
132	20.375	111.625	-
144	20.375	123.625	-
156	21.375	78	134.625
168	21.375	84	146.625
180	21.375	90	158.625
192	21.375	96	170.625
204	21.375	102	182.625
216	20.375	108	195.625
228	21.375	114	206.625
240	20.375	120	219.625

\*Hoop Base will not fit over a floor core.



# BASE LOCATIONS

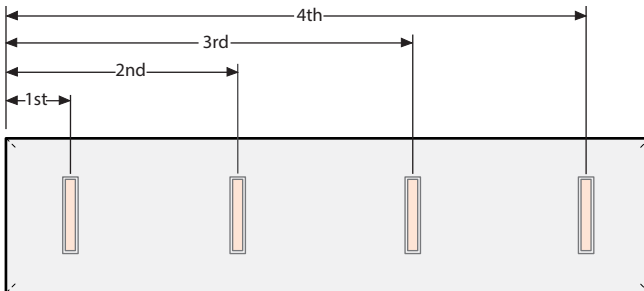
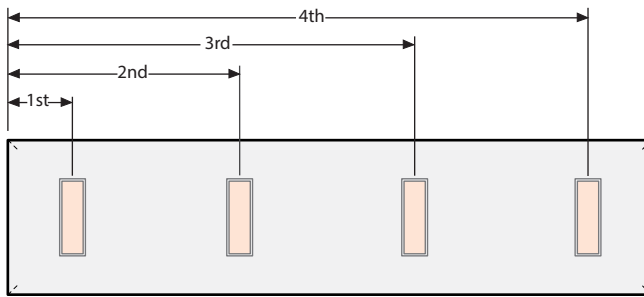
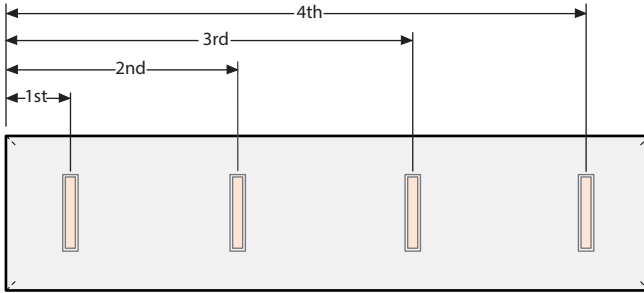

## RECTANGLE BASE (STONE TOP TABLES ONLY / ALL TABLE SHAPES)

Table Length	Center of 1st Base	Center of 2nd Base	Center of 3rd Base	Center of 4th Base
72	16.5	55.5	-	-
78	16.5	61.5	-	-
84	20.5	63.5	-	-
90	20.5	69.5	-	-
96	20.5	75.5	-	-
102	20.5	81.5	-	-
108	20.5	87.5	-	-
114	20.5	93.5	-	-
120	20.5	99.5	-	-
132	20.5	66	111.5	-
144	20.5	72	123.5	-
156	20.5	78	135.5	-
168	20.5	84	147.5	-
180	20.5	90	159.5	-
192	20.5	96	171.5	-
204	20.5	102	183.5	-
216	20.5	108	195.5	-
228	20.5	83.5	144.5	207.5
240	20.5	87.5	152.5	219.5

## COLUMN BASE (STONE TOP TABLES ONLY / ALL TABLE SHAPES)

Table Length	Center of 1st Base	Center of 2nd Base	Center of 3rd Base	Center of 4th Base
72	18.5	53.5	-	-
78	18.5	59.5	-	-
84	22.5	61.5	-	-
90	22.5	67.5	-	-
96	22.5	73.5	-	-
102	22.5	79.5	-	-
108	22.5	85.5	-	-
114	22.5	91.5	-	-
120	22.5	97.5	-	-
132	22.5	66	109.5	-
144	22.5	72	121.5	-
156	22.5	78	133.5	-
168	22.5	84	145.5	-
180	22.5	90	157.5	-
192	22.5	96	169.5	-
204	22.5	102	181.5	-
216	22.5	108	193.5	-
228	22.5	83.5	114.5	205.5
240	22.5	87.5	152.5	217.5

## HOOP BASE (STONE TOP TABLES ONLY / ALL TABLE SHAPES)

Table Length	Center of 1st Base	Center of 2nd Base	Center of 3rd Base	Center of 4th Base
72	17	55	-	-
78	17	61	-	-
84	21	63	-	-
90	21	69	-	-
96	21	75	-	-
102	21	81	-	-
108	21	87	-	-
114	21	93	-	-
120	21	99	-	-
132	21	66	111	-
144	21	72	123	-
156	21	78	135	-
168	21	84	147	-
180	21	90	159	-
192	21	96	171	-
204	21	102	183	-
216	21	108	195	-
228	21	83.5	144.5	207
240	21	87.5	152.5	219

\*Hoop Base will not fit over a floor core.



# BASE LOCATIONS

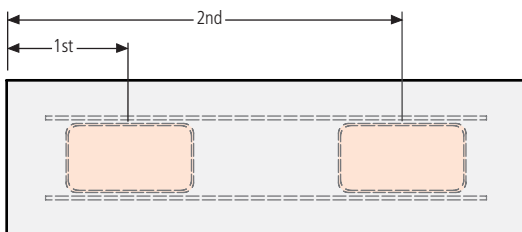
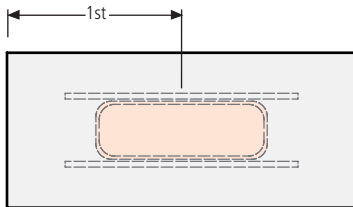
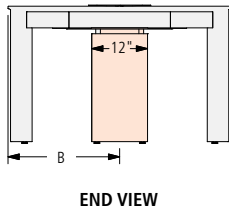
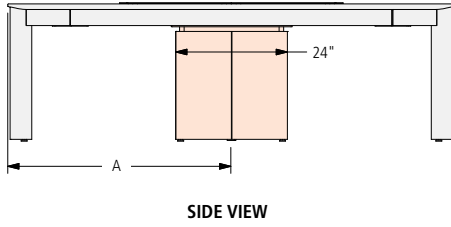

## CENTER COLUMN BASE LOCATION (ALL TABLE SHAPES)

Table Length	A
72	36
78	39
84	42
90	45
96	48
102	51
108	54
114	57
120	60
132	66
144	72
156	78
168	84
180	90
192	96
204	102
216	108
228	114
240	120

## CENTER COLUMN BASE LOCATION (ALL TABLE SHAPES)

Table Length	B
42	21
48	24
54	27
60	30
66	33
72	36

## ISLAND BASE (RECTANGLE AND RADIUS RECTANGLE)

Table Length	Center of 1st Base
108	54
114	57
120	60
132	66
144	72
156	78
168	84

## ISLAND BASE (RECTANGLE AND RADIUS RECTANGLE)

Table Length	Center of 1st Base	Center of 2nd Base
80	51	129
192	51	141
204	51	153
216	54	162
228	57	171
240	57	183



# VENEER TOP WITH HARDWOOD EDGE / METAL DOOR POWER ISLAND



FLOW XT RECTANGLE TOP

**BASE KEY**

PP	Painted Panel	TB	Metal T-Base	VP	Veneer Panel
PR	Painted Rectangle	P4	Metal Four Post with Painted Center Column	VR	Veneer Rectangle
PX	Painted Expandable Rectangle	V4	Metal Four Post with Veneer Center Column	VX	Veneer Expanded Rectangle
		HP	Metal Hoop		

**RECTANGLE TABLES**

MODEL #	L x W	BASE QTY	TOP SECTIONS	SEATING CAPACITY	-PP	-PR	-PX	-TB	-P4	-V4	-HP	-VP	-VR	-VX
FWXT-9642-V	96 x 42	2	2	8	-	23,866	24,331	23,147	23,866	24,331	-	-	24,331	24,824
FWXT-9648-V	96 x 48	2	2	8	23,295	24,571	25,052	23,827	24,571	25,052	25,052	23,820	25,052	25,562
FWXT-10242-V	102 x 42	2	2	8	-	25,528	26,019	24,769	25,528	26,019	-	-	26,019	26,540
FWXT-10248-V	102 x 48	2	2	8	24,960	26,307	26,815	25,522	26,307	26,815	26,815	25,514	26,815	27,354
FWXT-10842-V	108 x 42	2	2	10	-	26,740	27,231	25,981	26,740	27,231	-	-	27,231	27,752
FWXT-10848-V	108 x 48	2	2	10	26,208	27,555	28,063	26,770	27,555	28,063	28,063	26,763	28,063	28,602
FWXT-10854-V	108 x 54	2	2	12	27,113	28,519	29,050	27,699	28,519	29,050	29,050	27,691	29,050	29,612
FWXT-11442-V	114 x 42	2	2	10	-	28,436	28,952	27,637	28,436	28,952	-	-	28,952	29,500
FWXT-11448-V	114 x 48	2	2	10	27,915	29,332	29,867	28,506	29,332	29,867	29,867	28,498	29,867	30,434
FWXT-11454-V	114 x 54	2	2	12	28,909	30,390	30,948	29,527	30,390	30,948	30,948	29,518	30,948	31,540
FWXT-12042-V	120 x 42	2	2	10	-	29,660	30,177	28,862	29,660	30,177	-	-	30,177	30,725
FWXT-12048-V	120 x 48	2	2	10	29,177	30,594	31,129	29,768	30,594	31,129	31,129	29,760	31,129	31,696
FWXT-12054-V	120 x 54	2	2	12	30,214	31,694	32,253	30,831	31,694	32,253	32,253	30,823	32,253	32,845
FWXT-13248-V	132 x 48	2	2	10	32,117	33,593	34,150	32,733	33,593	34,150	34,150	32,724	34,150	34,741
FWXT-13254-V	132 x 54	2	2	12	33,287	34,829	35,411	33,930	34,829	35,411	35,411	33,921	35,411	36,028
FWXT-14448-V	144 x 48	2	2	12	35,103	36,639	37,218	35,744	36,639	37,218	37,218	35,735	37,218	37,832
FWXT-14454-V	144 x 54	2	2	14	36,414	38,018	38,622	37,083	38,018	38,622	38,622	37,074	38,622	39,264
FWXT-14460-V	144 x 60	2	2	14	37,937	39,626	40,263	38,641	39,626	40,263	40,263	38,632	40,263	40,939
FWXT-15654-V	156 x 54	3	2	14	41,608	44,038	44,955	42,622	44,038	44,955	44,955	42,608	44,955	45,927
FWXT-15660-V	156 x 60	3	2	14	43,382	45,941	46,907	44,449	45,941	46,907	46,907	44,435	46,907	47,931
FWXT-15666-V	156 x 66	3	3	14	47,996	50,711	51,735	-	50,711	51,735	51,735	49,113	51,735	52,821
FWXT-16854-V	168 x 54	3	2	16	44,366	46,796	47,713	45,379	46,796	47,713	47,713	45,366	47,713	48,685
FWXT-16860-V	168 x 60	3	2	16	46,253	48,812	49,778	47,320	48,812	49,778	49,778	47,306	49,778	50,802
FWXT-16866-V	168 x 66	3	3	16	51,158	53,873	54,897	-	53,873	54,897	54,897	52,275	54,897	55,983
FWXT-18054-V	180 x 54	3	2	16	47,122	49,553	50,469	48,136	49,553	50,469	50,469	48,122	50,469	51,442
FWXT-18060-V	180 x 60	3	2	16	49,123	51,682	52,648	50,190	51,682	52,648	52,648	50,176	52,648	53,672
FWXT-18066-V	180 x 66	3	3	16	54,319	57,033	58,057	-	57,033	58,057	58,057	55,436	58,057	59,143
FWXT-19254-V	192 x 54	3	2	18	49,880	52,311	53,227	50,894	52,311	53,227	53,227	50,880	53,227	54,199
FWXT-19260-V	192 x 60	3	2	18	51,994	54,553	55,519	53,061	54,553	55,519	55,519	53,047	55,519	56,543
FWXT-19266-V	192 x 66	3	3	18	57,481	60,195	61,219	-	60,195	61,219	61,219	58,598	61,219	62,305
FWXT-19272-V	192 x 72	3	3	18	58,924	61,638	62,662	-	61,638	62,662	62,662	60,041	62,662	63,748
FWXT-20454-V	204 x 54	3	2	18	53,412	55,941	56,895	54,467	55,941	56,895	56,895	54,453	56,895	57,907
FWXT-20460-V	204 x 60	3	2	18	55,728	58,392	59,397	56,840	58,392	59,397	59,397	56,824	59,397	60,462
FWXT-20466-V	204 x 66	3	3	18	61,741	64,566	65,632	-	64,566	65,632	65,632	62,903	65,632	66,762
FWXT-20472-V	204 x 72	3	3	18	63,337	66,162	67,228	-	66,162	67,228	67,228	64,499	67,228	68,358
FWXT-21654-V	216 x 54	3	2	20	56,705	59,296	60,273	57,786	59,296	60,273	60,273	57,771	60,273	61,309
FWXT-21660-V	216 x 60	3	2	20	59,198	61,927	62,956	60,336	61,927	62,956	62,956	60,321	62,956	64,048
FWXT-21666-V	216 x 66	3	3	20	65,667	68,561	69,652	-	68,561	69,652	69,652	66,858	69,652	70,810
FWXT-21672-V	216 x 72	3	3	20	67,399	70,293	71,384	-	70,293	71,384	71,384	68,590	71,384	72,542
FWXT-22854-V	228 x 54	3	2	20	59,723	62,339	63,325	60,815	62,339	63,325	63,325	60,800	63,325	64,372
FWXT-22860-V	228 x 60	3	2	20	62,363	65,117	66,156	63,512	65,117	66,156	66,156	63,496	66,156	67,258
FWXT-22866-V	228 x 66	3	3	20	69,206	72,127	73,229	-	72,127	73,229	73,229	70,408	73,229	74,398
FWXT-22872-V	228 x 72	3	3	20	71,051	73,972	75,074	-	73,972	75,074	75,074	72,253	75,074	76,243
FWXT-24054-V	240 x 54	3	2	20	62,802	65,447	66,444	63,905	65,447	66,444	66,444	63,890	66,444	67,502
FWXT-24060-V	240 x 60	3	2	20	65,593	68,378	69,429	66,755	68,378	69,429	69,429	66,739	69,429	70,543
FWXT-24066-V	240 x 66	3	3	20	72,830	75,785	76,899	-	75,785	76,899	76,899	74,046	76,899	78,081
FWXT-24072-V	240 x 72	3	3	20	74,794	77,749	78,863	-	77,749	78,863	78,863	76,010	78,863	80,045



# VENEER TOP WITH HARDWOOD EDGE / METAL DOOR POWER ISLAND

OPTIONS	CODE	PRICE	NOTES
<b>Power Island Storage Module Options:</b>			
One storage module in the center of the Power Island	Add <b>-SM47</b>		
One storage module at each end of the Power Island	Add <b>-SM43</b>		Only available on tables 144" and longer
One storage module in the center and one at each end of the Power Island	Add <b>-SM44</b>		Only available on tables 192" and longer
<b>Simplex/Charging USB Power Block Options:</b>			
Tables standard with (4) Power Blocks	Add <b>-CHPBC4</b>	\$457	
Tables standard with (8) Power Blocks	Add <b>-CHPBC8</b>	\$912	
Field-Wired:	Add <b>-FW</b>		Deduct \$641 per table
Plug-in Infeed (20-amp):	Add <b>-PI</b>	\$61	
<b>Center Column Base Finish Options:</b>			
Veneer Center Column Base*	Add <b>-CRV</b>	No Charge	To replace existing middle base (Hoop Base and T-Base only)
Painted Center Column Base*	Add <b>-CRP</b>	No Charge	To replace existing middle base (Hoop Base and T-Base only)
<b>Polished Chrome Finish Options:</b>			
Polished Chrome Four Post Base	Add <b>-PCFB</b>	\$2,558	*When specifying -CRV or -CRP in conjunction with a Polished Chrome finish on Hoop Base or T-Base tables with 3 bases, use the upcharge code and pricing for 2 base tables (-PCHP2 or -PCTB2).
Polished Chrome Hoop Base (on 2 base tables)	Add <b>-PCHP2</b>	\$2,558	
Polished Chrome Hoop Base (on 3 base tables)	Add <b>-PCHP3</b>	\$3,835	
Polished Chrome T-Base (on 2 base tables)	Add <b>-PCTB2</b>	\$2,558	
Polished Chrome T-Base (on 3 base tables)	Add <b>-PCTB3</b>	\$3,835	
T-Base Combination Finish (on 2 base tables)	Add <b>-PCCBF2</b>	\$1,566	
T-Base Combination Finish (on 3 base tables)	Add <b>-PCCBF3</b>	\$2,349	
<b>Multi-Section Tops:</b>			
204", 216", 228" or 240" two-piece tops split into three sections	Specify <b>-3</b>	\$1,140	

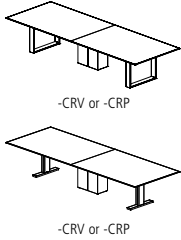

## EDGE PROFILE

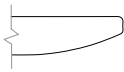

Reverse Flow Edge

## GENERAL INFORMATION

- Storage Modules, if specified, will have metal doors
- Tops are 1-1/8"-thick with 3/16"-deep hardwood edge band
- Seating capacity based on 27" per person
- Four Post Base includes a 12"x24" center column for wire management. Center column may be removed from tables 96" and shorter with options -4COLP or -4COLV above. On tables over 96", the center column is required for support.
- T-Base combination finish includes a Polished Chrome foot and Powder Coat vertical column
- Beam finish will match Metal Finish selection. If no Metal Finish is selected, beams will be Foil.
- If Polished Chrome Finish is specified on the T-Base or Hoop Base, the beams will be Foil. If Polished Chrome Finish is specified on the Four Post Base, the beams will be Clear Anodized.
- Overall table height 29.5"
- Power Island defaults to hardwire infeed option. Specify -PI for plug-in infeed option. Plug-in power infeed will only utilize one circuit of the two-circuit modular power system. To utilize both circuits, the hardwire power in-feed must be specified.
- Tables with three Hoop or T-Bases will default to the same base style for all three bases. An alternate Center Column Base may also be specified above.
- One wire manager included with the Hoop Base table (regardless of table size). Can be adhered to the leg and will default to the finish of the leg. If additional wire management channels are required, they can be purchased separately at the end of the pricelist.
- Center Wire Chase available on two base tables for more robust wire management needs. See page 128.
- If Simplex/Charging USB Power Blocks are specified, they replace the standard Power Blocks on the table. Simplex/Charging USB Power Blocks include one simplex receptacle and one charging USB-A+C.
- Panel, Rectangle, Expandable Rectangle, Metal T-base, and Center Column bases have a removable access panel

### REQUIRED INFORMATION (ORDER CANNOT BE ENTERED WITHOUT THIS INFORMATION)

See appendix pages vi-vii for surface material options.

- Choose Wood Species & Finish
- Choose Metal Finish. Clear Anodized (-CA) not available on T-Base or Hoop Base.
- Choose Paint Finish, if **-PP**, **-P4**, **-PR**, **-PX** or **-CRP** bases are selected





# VENEER TOP WITH HARDWOOD EDGE / METAL DOOR POWER ISLAND



FLOW XT  
RADIUS RECTANGLE TOP

**BASE KEY**

PP	Painted Panel	TB	Metal T-Base	VP	Veneer Panel
PR	Painted Rectangle	HP	Metal Hoop	VR	Veneer Rectangle
PX	Painted Expandable Rectangle			VX	Veneer Expanded Rectangle

**RADIUS RECTANGLE TABLES**

MODEL #	L x W	BASE QTY	TOP SECTIONS	SEATING CAPACITY	-PP	-PR	-PX	-TB	-HP	-VP	-VR	-VX
FWXC-9642-V	96 x 42	2	2	8	-	23,866	24,331	23,147	-	-	24,331	24,824
FWXC-9648-V	96 x 48	2	2	8	23,295	24,571	25,052	23,827	25,052	23,820	25,052	25,562
FWXC-10242-V	102 x 42	2	2	8	-	25,528	26,019	24,769	-	-	26,019	26,540
FWXC-10248-V	102 x 48	2	2	8	24,960	26,307	26,815	25,522	26,815	25,514	26,815	27,354
FWXC-10842-V	108 x 42	2	2	10	-	26,740	27,231	25,981	-	-	27,231	27,752
FWXC-10848-V	108 x 48	2	2	10	26,208	27,555	28,063	26,770	28,063	26,763	28,063	28,602
FWXC-10854-V	108 x 54	2	2	12	27,113	28,519	29,050	27,699	29,050	27,691	29,050	29,612
FWXC-11442-V	114 x 42	2	2	10	-	28,436	28,952	27,637	-	-	28,952	29,500
FWXC-11448-V	114 x 48	2	2	10	27,915	29,332	29,867	28,506	29,867	28,498	29,867	30,434
FWXC-11454-V	114 x 54	2	2	12	28,909	30,390	30,948	29,527	30,948	29,518	30,948	31,540
FWXC-12042-V	120 x 42	2	2	10	-	29,660	30,177	28,862	-	-	30,177	30,725
FWXC-12048-V	120 x 48	2	2	10	29,177	30,594	31,129	29,768	31,129	29,760	31,129	31,696
FWXC-12054-V	120 x 54	2	2	12	30,214	31,694	32,253	30,831	32,253	30,823	32,253	32,845
FWXC-13248-V	132 x 48	2	2	10	32,117	33,593	34,150	32,733	34,150	32,724	34,150	34,741
FWXC-13254-V	132 x 54	2	2	12	33,287	34,829	35,411	33,930	35,411	33,921	35,411	36,028
FWXC-14448-V	144 x 48	2	2	12	35,103	36,639	37,218	35,744	37,218	35,735	37,218	37,832
FWXC-14454-V	144 x 54	2	2	14	36,414	38,018	38,622	37,083	38,622	37,074	38,622	39,264
FWXC-14460-V	144 x 60	2	2	14	37,937	39,626	40,263	38,641	40,263	38,632	40,263	40,939
FWXC-15654-V	156 x 54	3	2	14	41,608	44,038	44,955	42,622	44,955	42,608	44,955	45,927
FWXC-15660-V	156 x 60	3	2	14	43,382	45,941	46,907	44,449	46,907	44,435	46,907	47,931
FWXC-15666-V	156 x 66	3	3	14	47,996	50,711	51,735	-	51,735	49,113	51,735	52,821
FWXC-16854-V	168 x 54	3	2	16	44,366	46,796	47,713	45,379	47,713	45,366	47,713	48,685
FWXC-16860-V	168 x 60	3	2	16	46,253	48,812	49,778	47,320	49,778	47,306	49,778	50,802
FWXC-16866-V	168 x 66	3	3	16	51,158	53,873	54,897	-	54,897	52,275	54,897	55,983
FWXC-18054-V	180 x 54	3	2	16	47,122	49,553	50,469	48,136	50,469	48,122	50,469	51,442
FWXC-18060-V	180 x 60	3	2	16	49,123	51,682	52,648	50,190	52,648	50,176	52,648	53,672
FWXC-18066-V	180 x 66	3	3	16	54,319	57,033	58,057	-	58,057	55,436	58,057	59,143
FWXC-19254-V	192 x 54	3	2	18	49,880	52,311	53,227	50,894	53,227	50,880	53,227	54,199
FWXC-19260-V	192 x 60	3	2	18	51,994	54,553	55,519	53,061	55,519	53,047	55,519	56,543
FWXC-19266-V	192 x 66	3	3	18	57,481	60,195	61,219	-	61,219	58,598	61,219	62,305
FWXC-19272-V	192 x 72	3	3	18	58,924	61,638	62,662	-	62,662	60,041	62,662	63,748
FWXC-20454-V	204 x 54	3	2	18	53,412	55,941	56,895	54,467	56,895	54,453	56,895	57,907
FWXC-20460-V	204 x 60	3	2	18	55,728	58,392	59,397	56,840	59,397	56,824	59,397	60,462
FWXC-20466-V	204 x 66	3	3	18	61,741	64,566	65,632	-	65,632	62,903	65,632	66,762
FWXC-20472-V	204 x 72	3	3	18	63,337	66,162	67,228	-	67,228	64,499	67,228	68,358
FWXC-21654-V	216 x 54	3	2	20	56,705	59,296	60,273	57,786	60,273	57,771	60,273	61,309
FWXC-21660-V	216 x 60	3	2	20	59,198	61,927	62,956	60,336	62,956	60,321	62,956	64,048
FWXC-21666-V	216 x 66	3	3	20	65,667	68,561	69,652	-	69,652	66,858	69,652	70,810
FWXC-21672-V	216 x 72	3	3	20	67,399	70,293	71,384	-	71,384	68,590	71,384	72,542
FWXC-22854-V	228 x 54	3	2	20	59,723	62,339	63,325	60,815	63,325	60,800	63,325	64,372
FWXC-22860-V	228 x 60	3	2	20	62,363	65,117	66,156	63,512	66,156	63,496	66,156	67,258
FWXC-22866-V	228 x 66	3	3	20	69,206	72,127	73,229	-	73,229	70,408	73,229	74,398
FWXC-22872-V	228 x 72	3	3	20	71,051	73,972	75,074	-	75,074	72,253	75,074	76,243
FWXC-24054-V	240 x 54	3	2	20	62,802	65,447	66,444	63,905	66,444	63,890	66,444	67,502
FWXC-24060-V	240 x 60	3	2	20	65,593	68,378	69,429	66,755	69,429	66,739	69,429	70,543
FWXC-24066-V	240 x 66	3	3	20	72,830	75,785	76,899	-	76,899	74,046	76,899	78,081
FWXC-24072-V	240 x 72	3	3	20	74,794	77,749	78,863	-	78,863	76,010	78,863	80,045



# VENEER TOP WITH HARDWOOD EDGE / METAL DOOR POWER ISLAND

OPTIONS	CODE	PRICE	NOTES
<b>Power Island Storage Module Options:</b>			
One storage module in the center of the Power Island	Add <b>-SM47</b>		
One storage module at each end of the Power Island	Add <b>-SM43</b>		Only available on tables 144" and longer
One storage module in the center and one at each end of the Power Island	Add <b>-SM44</b>		Only available on tables 192" and longer
<b>Simplex/Charging USB Power Block Options:</b>			
Tables standard with (4) Power Blocks	Add <b>-CHPBC4</b>	\$457	
Tables standard with (8) Power Blocks	Add <b>-CHPBC8</b>	\$912	
Field-Wired:	Add <b>-FW</b>		Deduct \$641 per table
Plug-in Infeed (20-amp):	Add <b>-PI</b>	\$61	
<b>Center Column Base Finish Options:</b>			
Veneer Center Column Base*	Add <b>-CRV</b>	No Charge	To replace existing middle base (Hoop Base and T-Base only)
Painted Center Column Base*	Add <b>-CRP</b>	No Charge	To replace existing middle base (Hoop Base and T-Base only)
<b>Polished Chrome Finish Options:</b>			
Polished Chrome Hoop Base (on 2 base tables)	Add <b>-PCHP2</b>	\$2,558	*When specifying -CRV or -CRP in conjunction with a Polished Chrome finish on Hoop Base or T-Base tables with 3 bases, use the upcharge code and pricing for 2 base tables (-PCHP2 or -PCTB2).
Polished Chrome Hoop Base (on 3 base tables)	Add <b>-PCHP3</b>	\$3,835	
Polished Chrome T-Base (on 2 base tables)	Add <b>-PCTB2</b>	\$2,558	
Polished Chrome T-Base (on 3 base tables)	Add <b>-PCTB3</b>	\$3,835	
T-Base Combination Finish (on 2 base tables)	Add <b>-PCCBF2</b>	\$1,566	
T-Base Combination Finish (on 3 base tables)	Add <b>-PCCBF3</b>	\$2,349	
<b>Multi-Section Tops:</b>			
204", 216", 228" or 240" two-piece tops split into three sections	Specify <b>-3</b>	\$1,140	

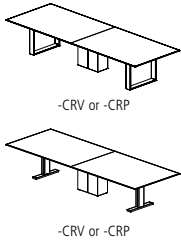

## EDGE PROFILE

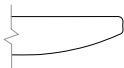

Reverse Flow Edge

## GENERAL INFORMATION

- Storage Modules, if specified, will have metal doors
- Tops are 1-1/8"-thick with 3/16"-deep hardwood edge band
- Seating capacity based on 27" per person
- T-Base combination finish includes a Polished Chrome foot and Powder Coat vertical column
- Beam finish will match Metal Finish selection. If no Metal Finish is selected, beams will be Foil.
- If Polished Chrome Finish is specified on the T-Base or Hoop Base, the beams will be Foil. If Polished Chrome Finish is specified on the Four Post Base, the beams will be Clear Anodized.
- Overall table height 29.5"
- Power Island defaults to hardwire infeed option. Specify -PI for plug-in infeed option. Plug-in power infeed will only utilize one circuit of the two-circuit modular power system. To utilize both circuits, the hardwire power in-feed must be specified.
- Tables with three Hoop or T-Bases will default to the same base style for all three bases. An alternate Center Column Base may also be specified above.
- One wire manager included with the Hoop Base table (regardless of table size). Can be adhered to the leg and will default to the finish of the leg. If additional wire management channels are required, they can be purchased separately at the end of the pricelist.
- Center Wire Chase available on two base tables for more robust wire management needs. See page 128.
- If Simplex/Charging USB Power Blocks are specified, they replace the standard Power Blocks on the table. Simplex/Charging USB Power Blocks include one simplex receptacle and one charging USB-A+C.
- Panel, Rectangle, Expandable Rectangle, Metal T-base, and Center Column bases have a removable access panel

### REQUIRED INFORMATION (ORDER CANNOT BE ENTERED WITHOUT THIS INFORMATION)

See appendix pages vi-vii for surface material options.

- Choose Wood Species & Finish
- Choose Metal Finish. Clear Anodized (-CA) not available on T-Base or Hoop Base.
- Choose Paint Finish, if **-PP**, **-PR**, **-PX** or **-CRP** bases are selected



# VENEER TOP WITH HARDWOOD EDGE / METAL DOOR POWER ISLAND

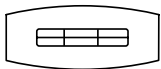

FLOW XT BOAT TOP

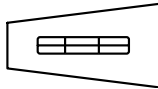

FLOW XT SIGHT LINE TOP

**BASE KEY**

PP Painted Panel  
 PR Painted Rectangle  
 PX Painted Expandable Rectangle

TB Metal T-Base  
 P4 Metal Four Post with Painted Center Column  
 V4 Metal Four Post with Veneer Center Column  
 HP Metal Hoop

VP Veneer Panel  
 VR Veneer Rectangle  
 VX Veneer Expanded Rectangle

**BOAT TABLES**

MODEL #	L x W	BASE QTY	TOP SECTIONS	SEATING CAPACITY	-PP	-PR	-PX	-TB	-P4	-V4	-HP	-VP	-VR	-VX
FWXB-9648-V	96 x 36/48	2	2		23,295	24,571	25,052	23,827	24,571	25,052	25,052	23,820	25,052	25,562
FWXB-10248-V	102 x 36/48	2	2		24,960	26,307	26,815	25,522	26,307	26,815	26,815	25,514	26,815	27,354
FWXB-10848-V	108 x 36/48	2	2		26,208	27,555	28,063	26,770	27,555	28,063	28,063	26,763	28,063	28,602
FWXB-11450-V	114 x 36/50	2	2		28,517	29,998	30,556	29,135	29,998	30,556	30,556	29,126	30,556	31,148
FWXB-12050-V	120 x 36/50	2	2		29,802	31,282	31,841	30,419	31,282	31,841	31,841	30,411	31,841	32,433
FWXB-13254-V	132 x 36/54	2	2		33,287	34,829	35,411	33,930	34,829	35,411	35,411	33,921	35,411	36,028
FWXB-14454-V	144 x 36/54	2	2		36,414	38,018	38,622	37,083	38,018	38,622	38,622	37,074	38,622	39,264
FWXB-15654-V	156 x 36/54	3	2		41,608	44,038	44,955	42,622	44,038	44,955	44,955	42,608	44,955	45,927
FWXB-16860-V	168 x 42/60	3	2		46,253	48,812	49,778	47,320	48,812	49,778	49,778	47,306	49,778	50,802
FWXB-18060-V	180 x 42/60	3	2		49,123	51,682	52,648	50,190	51,682	52,648	52,648	50,176	52,648	53,672
FWXB-19272-V	192 x 54/72	3	3		58,924	61,638	62,662	-	61,638	62,662	62,662	60,041	62,662	63,748
FWXB-20472-V	204 x 54/72	3	3		63,337	66,162	67,228	-	66,162	67,228	67,228	64,499	67,228	68,358
FWXB-21672-V	216 x 54/72	3	3		67,399	70,293	71,384	-	70,293	71,384	71,384	68,590	71,384	72,542
FWXB-22872-V	228 x 54/72	3	3		71,051	73,972	75,074	-	73,972	75,074	75,074	72,253	75,074	76,243
FWXB-24072-V	240 x 54/72	3	3		74,794	77,749	78,863	-	77,749	78,863	78,863	76,010	78,863	80,045

**SIGHT LINE TABLES**

MODEL #	L x W	BASE QTY	TOP SECTIONS	SEATING CAPACITY	-PP	-PR	-PX	-TB	-P4	-V4	-HP	-VP	-VR	-VX
FWXA-9660-V	96 x 36/60	2	2		24,983	26,386	26,916	25,568	-	-	26,916	25,560	26,916	27,477
FWXA-10260-V	102 x 36/60	2	2		26,829	28,311	28,869	27,447	-	-	28,869	27,439	28,869	29,462
FWXA-10860-V	108 x 36/60	2	2		28,166	29,647	30,206	28,784	-	-	30,206	28,776	30,206	30,799
FWXA-11460-V	114 x 36/60	2	2		30,068	31,627	32,215	30,718	-	-	32,215	30,709	32,215	32,839
FWXA-12066-V	120 x 36/66	2	2		34,717	36,371	36,994	35,407	-	-	36,994	35,397	36,994	37,656
FWXA-13268-V	132 x 36/68	2	3		38,667	40,390	41,040	39,386	-	-	41,040	39,376	41,040	41,729
FWXA-14470-V	144 x 36/70	2	3		42,786	44,577	45,253	-	-	-	45,253	43,523	45,253	45,970
FWXA-15672-V	156 x 36/72	3	3		49,169	51,884	52,908	-	-	-	52,908	50,286	52,908	53,994
FWXA-16876-V	168 x 36/76	3	3		52,532	55,169	56,164	-	-	-	56,164	53,617	56,164	57,219
FWXA-18078-V	180 x 36/78	3	3		56,243	58,880	59,875	-	-	-	59,875	57,328	59,875	60,929
FWXA-19278-V	192 x 36/78	3	3		59,546	62,183	63,178	-	-	-	63,178	60,631	63,178	64,233
FWXA-20478-V	204 x 36/78	3	3		64,037	66,782	67,817	-	-	-	67,817	65,166	67,817	68,915
FWXA-21678-V	216 x 36/78	3	3		68,171	70,982	72,042	-	-	-	72,042	69,327	72,042	73,167
FWXA-22878-V	228 x 36/78	3	3		71,885	74,723	75,794	-	-	-	75,794	73,053	75,794	76,929
FWXA-24078-V	240 x 36/78	3	3		75,693	78,563	79,646	-	-	-	79,646	76,874	79,646	80,794



# VENEER TOP WITH HARDWOOD EDGE / METAL DOOR POWER ISLAND

OPTIONS	CODE	PRICE	NOTES
<b>Power Island Storage Module Options:</b>			
One storage module in the center of the Power Island	Add <b>-SM47</b>		
One storage module at each end of the Power Island	Add <b>-SM43</b>		Only available on tables 144" and longer
One storage module in the center and one at each end of the Power Island	Add <b>-SM44</b>		Only available on tables 192" and longer
<b>Simplex/Charging USB Power Block Options:</b>			
Tables standard with (4) Power Blocks	Add <b>-CHPBC4</b>	\$457	
Tables standard with (8) Power Blocks	Add <b>-CHPBC8</b>	\$912	
Field-Wired:	Add <b>-FW</b>		Deduct \$641 per table
Plug-in Infeed (20-amp):	Add <b>-PI</b>	\$61	
<b>Center Column Base Finish Options:</b>			
Veneer Center Column Base*	Add <b>-CRV</b>	No Charge	To replace existing middle base (Hoop Base and T-Base only)
Painted Center Column Base*	Add <b>-CRP</b>	No Charge	To replace existing middle base (Hoop Base and T-Base only)
<b>Polished Chrome Finish Options:</b>			
Polished Chrome Four Post Base	Add <b>-PCFB</b>	\$2,558	*When specifying -CRV or -CRP in conjunction with a Polished Chrome finish on Hoop Base or T-Base tables with 3 bases, use the upcharge code and pricing for 2 base tables (-PCHP2 or -PCTB2).
Polished Chrome Hoop Base (on 2 base tables)	Add <b>-PCHP2</b>	\$2,558	
Polished Chrome Hoop Base (on 3 base tables)	Add <b>-PCHP3</b>	\$3,835	
Polished Chrome T-Base (on 2 base tables)	Add <b>-PCTB2</b>	\$2,558	
Polished Chrome T-Base (on 3 base tables)	Add <b>-PCTB3</b>	\$3,835	
T-Base Combination Finish (on 2 base tables)	Add <b>-PCCBF2</b>	\$1,566	
T-Base Combination Finish (on 3 base tables)	Add <b>-PCCBF3</b>	\$2,349	
<b>Multi-Section Tops:</b>			
204", 216", 228" or 240" two-piece tops split into three sections	Specify <b>-3</b>	\$1,140	

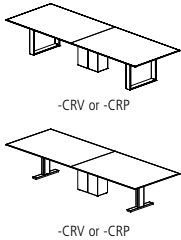

## EDGE PROFILE

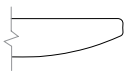

Reverse Flow Edge

## GENERAL INFORMATION

- Storage Modules, if specified, will have metal doors
- Tops are 1-1/8"-thick with 3/16"-deep hardwood edge band
- Seating capacity based on 27" per person
- Four Post Base includes a 12"x24" center column for wire management. Center column may be removed from tables 96" and shorter with options -4COLP or -4COLV above. On tables over 96", the center column is required for support.
- T-Base combination finish includes a Polished Chrome foot and Powder Coat vertical column
- Beam finish will match Metal Finish selection. If no Metal Finish is selected, beams will be Foil.
- If Polished Chrome Finish is specified on the T-Base or Hoop Base, the beams will be Foil. If Polished Chrome Finish is specified on the Four Post Base, the beams will be Clear Anodized.
- Overall table height 29.5"
- Power Island defaults to hardwire infeed option. Specify -PI for plug-in infeed option. Plug-in power infeed will only utilize one circuit of the two-circuit modular power system. To utilize both circuits, the hardwire power in-feed must be specified.
- Tables with three Hoop or T-Bases will default to the same base style for all three bases. An alternate Center Column Base may also be specified above.
- One wire manager included with the Hoop Base table (regardless of table size). Can be adhered to the leg and will default to the finish of the leg. If additional wire management channels are required, they can be purchased separately at the end of the pricelist.
- Center Wire Chase available on two base tables for more robust wire management needs. See page 128.
- If Simplex/Charging USB Power Blocks are specified, they replace the standard Power Blocks on the table. Simplex/Charging USB Power Blocks include one simplex receptacle and one charging USB-A+C.
- Panel, Rectangle, Expandable Rectangle, Metal T-base, and Center Column bases have a removable access panel

### REQUIRED INFORMATION (ORDER CANNOT BE ENTERED WITHOUT THIS INFORMATION)

See appendix pages vi-vii for surface material options.

- Choose Wood Species & Finish
- Choose Metal Finish. Clear Anodized (-CA) not available on T-Base or Hoop Base.
- Choose Paint Finish, if **-PP**, **-P4**, **-PR**, **-PX** or **-CRP** bases are selected



# VENEER TOP WITH HARDWOOD EDGE / GLASS DOOR POWER ISLAND



FLOW XT RECTANGLE TOP

**BASE KEY**

PP Painted Panel  
 PR Painted Rectangle  
 PX Painted Expandable Rectangle

TB Metal T-Base  
 P4 Metal Four Post with Painted Center Column  
 V4 Metal Four Post with Veneer Center Column  
 HP Metal Hoop

VP Veneer Panel  
 VR Veneer Rectangle  
 VX Veneer Expanded Rectangle

**RECTANGLE TABLES**

MODEL #	L x W	BASE QTY	TOP SECTIONS	SEATING CAPACITY	-PP	-PR	-PX	-TB	-P4	-V4	-HP	-VP	-VR	-VX
FWGT-9642-V	96 x 42	2	2	8	-	25,914	26,379	25,195	25,914	26,379	-	-	26,379	26,872
FWGT-9648-V	96 x 48	2	2	8	25,343	26,619	27,100	25,875	26,619	27,100	27,100	25,868	27,100	27,610
FWGT-10242-V	102 x 42	2	2	8	-	27,703	28,194	26,944	27,703	28,194	-	-	28,194	28,715
FWGT-10248-V	102 x 48	2	2	8	27,135	28,482	28,990	27,697	28,482	28,990	28,990	27,689	28,990	29,529
FWGT-10842-V	108 x 42	2	2	10	-	29,044	29,535	28,285	29,044	29,535	-	-	29,535	30,056
FWGT-10848-V	108 x 48	2	2	10	28,512	29,859	30,367	29,074	29,859	30,367	30,367	29,067	30,367	30,906
FWGT-10854-V	108 x 54	2	2	12	29,417	30,823	31,354	30,003	30,823	31,354	31,354	29,995	31,354	31,916
FWGT-11442-V	114 x 42	2	2	10	-	30,868	31,384	30,069	30,868	31,384	-	-	31,384	31,932
FWGT-11448-V	114 x 48	2	2	10	30,347	31,764	32,299	30,938	31,764	32,299	32,299	30,930	32,299	32,866
FWGT-11454-V	114 x 54	2	2	12	31,341	32,822	33,380	31,959	32,822	33,380	33,380	31,950	33,380	33,972
FWGT-12042-V	120 x 42	2	2	10	-	32,220	32,737	31,422	32,220	32,737	-	-	32,737	33,285
FWGT-12048-V	120 x 48	2	2	10	31,737	33,154	33,689	32,328	33,154	33,689	33,689	32,320	33,689	34,256
FWGT-12054-V	120 x 54	2	2	12	32,774	34,254	34,813	33,391	34,254	34,813	34,813	33,383	34,813	35,405
FWGT-13248-V	132 x 48	2	2	10	34,933	36,409	36,966	35,549	36,409	36,966	36,966	35,540	36,966	37,557
FWGT-13254-V	132 x 54	2	2	12	36,103	37,645	38,227	36,746	37,645	38,227	38,227	36,737	38,227	38,844
FWGT-14448-V	144 x 48	2	2	12	38,174	39,710	40,289	38,815	39,710	40,289	40,289	38,806	40,289	40,903
FWGT-14454-V	144 x 54	2	2	14	39,485	41,089	41,693	40,154	41,089	41,693	41,693	40,145	41,693	42,335
FWGT-14460-V	144 x 60	2	2	14	41,008	42,697	43,334	41,712	42,697	43,334	43,334	41,703	43,334	44,010
FWGT-15654-V	156 x 54	3	2	14	44,936	47,366	48,283	45,950	47,366	48,283	48,283	45,936	48,283	49,255
FWGT-15660-V	156 x 60	3	2	14	46,710	49,269	50,235	47,777	49,269	50,235	50,235	47,763	50,235	51,259
FWGT-15666-V	156 x 66	3	3	14	51,324	54,039	55,063	-	54,039	55,063	55,063	52,441	55,063	56,149
FWGT-16854-V	168 x 54	3	2	16	47,949	50,379	51,296	48,962	50,379	51,296	51,296	48,949	51,296	52,268
FWGT-16860-V	168 x 60	3	2	16	49,836	52,395	53,361	50,903	52,395	53,361	53,361	50,889	53,361	54,385
FWGT-16866-V	168 x 66	3	3	16	54,741	57,456	58,480	-	57,456	58,480	58,480	55,858	58,480	59,566
FWGT-18054-V	180 x 54	3	2	16	50,962	53,393	54,309	51,976	53,393	54,309	54,309	51,962	54,309	55,282
FWGT-18060-V	180 x 60	3	2	16	52,963	55,522	56,488	54,030	55,522	56,488	56,488	54,016	56,488	57,512
FWGT-18066-V	180 x 66	3	3	16	58,159	60,873	61,897	-	60,873	61,897	61,897	59,276	61,897	62,983
FWGT-19254-V	192 x 54	3	2	18	53,975	56,406	57,322	54,989	56,406	57,322	57,322	54,975	57,322	58,294
FWGT-19260-V	192 x 60	3	2	18	56,089	58,648	59,614	57,156	58,648	59,614	59,614	57,142	59,614	60,638
FWGT-19266-V	192 x 66	3	3	18	61,576	64,290	65,314	-	64,290	65,314	65,314	62,693	65,314	66,400
FWGT-19272-V	192 x 72	3	3	18	63,019	65,733	66,757	-	65,733	66,757	66,757	64,136	66,757	67,843
FWGT-20454-V	204 x 54	3	2	18	57,763	60,292	61,246	58,818	60,292	61,246	61,246	58,804	61,246	62,258
FWGT-20460-V	204 x 60	3	2	18	60,079	62,743	63,748	61,191	62,743	63,748	63,748	61,175	63,748	64,813
FWGT-20466-V	204 x 66	3	3	18	66,092	68,917	69,983	-	68,917	69,983	69,983	67,254	69,983	71,113
FWGT-20472-V	204 x 72	3	3	18	67,688	70,513	71,579	-	70,513	71,579	71,579	68,850	71,579	72,709
FWGT-21654-V	216 x 54	3	2	20	61,313	63,904	64,881	62,394	63,904	64,881	64,881	62,379	64,881	65,917
FWGT-21660-V	216 x 60	3	2	20	63,806	66,535	67,564	64,944	66,535	67,564	67,564	64,929	67,564	68,656
FWGT-21666-V	216 x 66	3	3	20	70,275	73,169	74,260	-	73,169	74,260	74,260	71,466	74,260	75,418
FWGT-21672-V	216 x 72	3	3	20	72,007	74,901	75,992	-	74,901	75,992	75,992	73,198	75,992	77,150
FWGT-22854-V	228 x 54	3	2	20	64,586	67,202	68,188	65,678	67,202	68,188	68,188	65,663	68,188	69,235
FWGT-22860-V	228 x 60	3	2	20	67,226	69,980	71,019	68,375	69,980	71,019	71,019	68,359	71,019	72,121
FWGT-22866-V	228 x 66	3	3	20	74,069	76,990	78,092	-	76,990	78,092	78,092	75,271	78,092	79,261
FWGT-22872-V	228 x 72	3	3	20	75,914	78,835	79,937	-	78,835	79,937	79,937	77,116	79,937	81,106
FWGT-24054-V	240 x 54	3	2	20	67,922	70,567	71,564	69,025	70,567	71,564	71,564	69,010	71,564	72,622
FWGT-24060-V	240 x 60	3	2	20	70,713	73,498	74,549	71,875	73,498	74,549	74,549	71,859	74,549	75,663
FWGT-24066-V	240 x 66	3	3	20	77,950	80,905	82,019	-	80,905	82,019	82,019	79,166	82,019	83,201
FWGT-24072-V	240 x 72	3	3	20	79,914	82,869	83,983	-	82,869	83,983	83,983	81,130	83,983	85,165



# VENEER TOP WITH HARDWOOD EDGE / GLASS DOOR POWER ISLAND

OPTIONS	CODE	PRICE	NOTES
<b>Power Island Storage Module Options:</b>			
One storage module in the center of the Power Island	Add <b>-SM47</b>		
One storage module at each end of the Power Island	Add <b>-SM43</b>		Only available on tables 144" and longer
One storage module in the center and one at each end of the Power Island	Add <b>-SM44</b>		Only available on tables 192" and longer
<b>Simplex/Charging USB Power Block Options:</b>			
Tables standard with (4) Power Blocks	Add <b>-CHPBC4</b>	\$457	
Tables standard with (8) Power Blocks	Add <b>-CHPBC8</b>	\$912	
Field-Wired:	Add <b>-FW</b>		Deduct \$641 per table
Plug-in Infeed (20-amp):	Add <b>-PI</b>	\$61	
<b>Center Column Base Finish Options:</b>			
Veneer Center Column Base*	Add <b>-CRV</b>	No Charge	To replace existing middle base (Hoop Base and T-Base only)
Painted Center Column Base*	Add <b>-CRP</b>	No Charge	To replace existing middle base (Hoop Base and T-Base only)
<b>Polished Chrome Finish Options:</b>			
Polished Chrome Four Post Base	Add <b>-PCFB</b>	\$2,558	*When specifying -CRV or -CRP in conjunction with a Polished Chrome finish on Hoop Base or T-Base tables with 3 bases, use the upcharge code and pricing for 2 base tables (-PCHP2 or -PCTB2).
Polished Chrome Hoop Base (on 2 base tables)	Add <b>-PCHP2</b>	\$2,558	
Polished Chrome Hoop Base (on 3 base tables)	Add <b>-PCHP3</b>	\$3,835	
Polished Chrome T-Base (on 2 base tables)	Add <b>-PCTB2</b>	\$2,558	
Polished Chrome T-Base (on 3 base tables)	Add <b>-PCTB3</b>	\$3,835	
T-Base Combination Finish (on 2 base tables)	Add <b>-PCCBF2</b>	\$1,566	
T-Base Combination Finish (on 3 base tables)	Add <b>-PCCBF3</b>	\$2,349	
<b>Multi-Section Tops:</b>			
204", 216", 228" or 240" two-piece tops split into three sections	Specify -3	\$1,140	

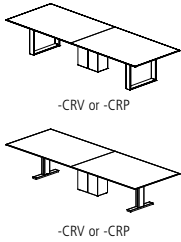

## EDGE PROFILE

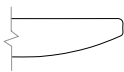

Reverse Flow Edge

## GENERAL INFORMATION

- Storage Modules, if specified, will have metal doors
- Tops are 1-1/8"-thick with 3/16"-deep hardwood edge band
- Seating capacity based on 27" per person
- Four Post Base includes a 12"x24" center column for wire management. Center column may be removed from tables 96" and shorter with options -4COLP or -4COLV above. On tables over 96", the center column is required for support.
- T-Base combination finish includes a Polished Chrome foot and Powder Coat vertical column
- Beam finish will match Metal Finish selection. If no Metal Finish is selected, beams will be Foil.
- If Polished Chrome Finish is specified on the T-Base or Hoop Base, the beams will be Foil. If Polished Chrome Finish is specified on the Four Post Base, the beams will be Clear Anodized.
- Overall table height 29.5"
- Power Island defaults to hardwire infeed option. Specify -PI for plug-in infeed option. Plug-in power infeed will only utilize one circuit of the two-circuit modular power system. To utilize both circuits, the hardwire power in-feed must be specified.
- Tables with three Hoop or T-Bases will default to the same base style for all three bases. An alternate Center Column Base may also be specified above.
- One wire manager included with the Hoop Base table (regardless of table size). Can be adhered to the leg and will default to the finish of the leg. If additional wire management channels are required, they can be purchased separately at the end of the pricelist.
- Center Wire Chase available on two base tables for more robust wire management needs. See page 128.
- If Simplex/Charging USB Power Blocks are specified, they replace the standard Power Blocks on the table. Simplex/Charging USB Power Blocks include one simplex receptacle and one charging USB-A+C.
- Panel, Rectangle, Expandable Rectangle, Metal T-base, and Center Column bases have a removable access panel

### REQUIRED INFORMATION (ORDER CANNOT BE ENTERED WITHOUT THIS INFORMATION)

See appendix pages vi-vii for surface material options.

- Choose Glass Finish: Gloss Glass only
- Choose Wood Species & Finish
- Choose Metal Finish. Clear Anodized (-CA) not available on T-Base or Hoop Base.
- Choose Paint Finish, if **-PP**, **-P4**, **-PR**, **-PX** or **-CRP** bases are selected



# VENEER TOP WITH HARDWOOD EDGE / GLASS DOOR POWER ISLAND

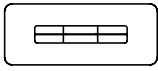

FLOW XT  
RADIUS RECTANGLE TOP

**BASE KEY**

PP	Painted Panel	TB	Metal T-Base	VP	Veneer Panel
PR	Painted Rectangle	HP	Metal Hoop	VR	Veneer Rectangle
PX	Painted Expandable Rectangle			VX	Veneer Expanded Rectangle

**RADIUS RECTANGLE TABLES**

MODEL #	L x W	BASE QTY	TOP SECTIONS	SEATING CAPACITY	-PP	-PR	-PX	-TB	-HP	-VP	-VR	-VX
FWGC-9642-V	96 x 42	2	2	8	-	25,914	26,379	25,195	-	-	26,379	26,872
FWGC-9648-V	96 x 48	2	2	8	25,343	26,619	27,100	25,875	27,100	25,868	27,100	27,610
FWGC-10242-V	102 x 42	2	2	8	-	27,703	28,194	26,944	-	-	28,194	28,715
FWGC-10248-V	102 x 48	2	2	8	27,135	28,482	28,990	27,697	28,990	27,689	28,990	29,529
FWGC-10842-V	108 x 42	2	2	10	-	29,044	29,535	28,285	-	-	29,535	30,056
FWGC-10848-V	108 x 48	2	2	10	28,512	29,859	30,367	29,074	30,367	29,067	30,367	30,906
FWGC-10854-V	108 x 54	2	2	12	29,417	30,823	31,354	30,003	31,354	29,995	31,354	31,916
FWGC-11442-V	114 x 42	2	2	10	-	30,868	31,384	30,069	-	-	31,384	31,932
FWGC-11448-V	114 x 48	2	2	10	30,347	31,764	32,299	30,938	32,299	30,930	32,299	32,866
FWGC-11454-V	114 x 54	2	2	12	31,341	32,822	33,380	31,959	33,380	31,950	33,380	33,972
FWGC-12042-V	120 x 42	2	2	10	-	32,220	32,737	31,422	-	-	32,737	33,285
FWGC-12048-V	120 x 48	2	2	10	31,737	33,154	33,689	32,328	33,689	32,320	33,689	34,256
FWGC-12054-V	120 x 54	2	2	12	32,774	34,254	34,813	33,391	34,813	33,383	34,813	35,405
FWGC-13248-V	132 x 48	2	2	10	34,933	36,409	36,966	35,549	36,966	35,540	36,966	37,557
FWGC-13254-V	132 x 54	2	2	12	36,103	37,645	38,227	36,746	38,227	36,737	38,227	38,844
FWGC-14448-V	144 x 48	2	2	12	38,174	39,710	40,289	38,815	40,289	38,806	40,289	40,903
FWGC-14454-V	144 x 54	2	2	14	39,485	41,089	41,693	40,154	41,693	40,145	41,693	42,335
FWGC-14460-V	144 x 60	2	2	14	41,008	42,697	43,334	41,712	43,334	41,703	43,334	44,010
FWGC-15654-V	156 x 54	3	2	14	44,936	47,366	48,283	45,950	48,283	45,936	48,283	49,255
FWGC-15660-V	156 x 60	3	2	14	46,710	49,269	50,235	47,777	50,235	47,763	50,235	51,259
FWGC-15666-V	156 x 66	3	3	14	51,324	54,039	55,063	-	55,063	52,441	55,063	56,149
FWGC-16854-V	168 x 54	3	2	16	47,949	50,379	51,296	48,962	51,296	48,949	51,296	52,268
FWGC-16860-V	168 x 60	3	2	16	49,836	52,395	53,361	50,903	53,361	50,889	53,361	54,385
FWGC-16866-V	168 x 66	3	3	16	54,741	57,456	58,480	-	58,480	55,858	58,480	59,566
FWGC-18054-V	180 x 54	3	2	16	50,962	53,393	54,309	51,976	54,309	51,962	54,309	55,282
FWGC-18060-V	180 x 60	3	2	16	52,963	55,522	56,488	54,030	56,488	54,016	56,488	57,512
FWGC-18066-V	180 x 66	3	3	16	58,159	60,873	61,897	-	61,897	59,276	61,897	62,983
FWGC-19254-V	192 x 54	3	2	18	53,975	56,406	57,322	54,989	57,322	54,975	57,322	58,294
FWGC-19260-V	192 x 60	3	2	18	56,089	58,648	59,614	57,156	59,614	57,142	59,614	60,638
FWGC-19266-V	192 x 66	3	3	18	61,576	64,290	65,314	-	65,314	62,693	65,314	66,400
FWGC-19272-V	192 x 72	3	3	18	63,019	65,733	66,757	-	66,757	64,136	66,757	67,843
FWGC-20454-V	204 x 54	3	2	18	57,763	60,292	61,246	58,818	61,246	58,804	61,246	62,258
FWGC-20460-V	204 x 60	3	2	18	60,079	62,743	63,748	61,191	63,748	61,175	63,748	64,813
FWGC-20466-V	204 x 66	3	3	18	66,092	68,917	69,983	-	69,983	67,254	69,983	71,113
FWGC-20472-V	204 x 72	3	3	18	67,688	70,513	71,579	-	71,579	68,850	71,579	72,709
FWGC-21654-V	216 x 54	3	2	20	61,313	63,904	64,881	62,394	64,881	62,379	64,881	65,917
FWGC-21660-V	216 x 60	3	2	20	63,806	66,535	67,564	64,944	67,564	64,929	67,564	68,656
FWGC-21666-V	216 x 66	3	3	20	70,275	73,169	74,260	-	74,260	71,466	74,260	75,418
FWGC-21672-V	216 x 72	3	3	20	72,007	74,901	75,992	-	75,992	73,198	75,992	77,150
FWGC-22854-V	228 x 54	3	2	20	64,586	67,202	68,188	65,678	68,188	65,663	68,188	69,235
FWGC-22860-V	228 x 60	3	2	20	67,226	69,980	71,019	68,375	71,019	68,359	71,019	72,121
FWGC-22866-V	228 x 66	3	3	20	74,069	76,990	78,092	-	78,092	75,271	78,092	79,261
FWGC-22872-V	228 x 72	3	3	20	75,914	78,835	79,937	-	79,937	77,116	79,937	81,106
FWGC-24054-V	240 x 54	3	2	20	67,922	70,567	71,564	69,025	71,564	69,010	71,564	72,622
FWGC-24060-V	240 x 60	3	2	20	70,713	73,498	74,549	71,875	74,549	71,859	74,549	75,663
FWGC-24066-V	240 x 66	3	3	20	77,950	80,905	82,019	-	82,019	79,166	82,019	83,201
FWGC-24072-V	240 x 72	3	3	20	79,914	82,869	83,983	-	83,983	81,130	83,983	85,165



# VENEER TOP WITH HARDWOOD EDGE / GLASS DOOR POWER ISLAND

OPTIONS	CODE	PRICE	NOTES
<b>Power Island Storage Module Options:</b>			
One storage module in the center of the Power Island	Add <b>-SM47</b>		
One storage module at each end of the Power Island	Add <b>-SM43</b>		Only available on tables 144" and longer
One storage module in the center and one at each end of the Power Island	Add <b>-SM44</b>		Only available on tables 192" and longer
<b>Simplex/Charging USB Power Block Options:</b>			
Tables standard with (4) Power Blocks	Add <b>-CHPBC4</b>	\$457	
Tables standard with (8) Power Blocks	Add <b>-CHPBC8</b>	\$912	
Field-Wired:	Add <b>-FW</b>		Deduct \$641 per table
Plug-in Infeed (20-amp):	Add <b>-PI</b>	\$61	
<b>Center Column Base Finish Options:</b>			
Veneer Center Column Base*	Add <b>-CRV</b>	No Charge	To replace existing middle base (Hoop Base and T-Base only)
Painted Center Column Base*	Add <b>-CRP</b>	No Charge	To replace existing middle base (Hoop Base and T-Base only)
<b>Polished Chrome Finish Options:</b>			
Polished Chrome Hoop Base (on 2 base tables)	Add <b>-PCHP2</b>	\$2,558	*When specifying -CRV or -CRP in conjunction with a Polished Chrome finish on Hoop Base or T-Base tables with 3 bases, use the upcharge code and pricing for 2 base tables (-PCHP2 or -PCTB2).
Polished Chrome Hoop Base (on 3 base tables)	Add <b>-PCHP3</b>	\$3,835	
Polished Chrome T-Base (on 2 base tables)	Add <b>-PCTB2</b>	\$2,558	
Polished Chrome T-Base (on 3 base tables)	Add <b>-PCTB3</b>	\$3,835	
T-Base Combination Finish (on 2 base tables)	Add <b>-PCCBF2</b>	\$1,566	
T-Base Combination Finish (on 3 base tables)	Add <b>-PCCBF3</b>	\$2,349	
<b>Multi-Section Tops:</b>			
204", 216", 228" or 240" two-piece tops split into three sections	Specify <b>-3</b>	\$1,140	

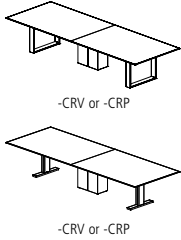

## EDGE PROFILE

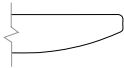

Reverse Flow Edge

## GENERAL INFORMATION

- Storage Modules, if specified, will have metal doors
- Tops are 1-1/8"-thick with 3/16"-deep hardwood edge band
- Seating capacity based on 27" per person
- T-Base combination finish includes a Polished Chrome foot and Powder Coat vertical column
- Beam finish will match Metal Finish selection. If no Metal Finish is selected, beams will be Foil.
- If Polished Chrome Finish is specified on the T-Base or Hoop Base, the beams will be Foil. If Polished Chrome Finish is specified on the Four Post Base, the beams will be Clear Anodized.
- Overall table height 29.5"
- Power Island defaults to hardwire infeed option. Specify -PI for plug-in infeed option. Plug-in power infeed will only utilize one circuit of the two-circuit modular power system. To utilize both circuits, the hardwire power in-feed must be specified.
- Tables with three Hoop or T-Bases will default to the same base style for all three bases. An alternate Center Column Base may also be specified above.
- One wire manager included with the Hoop Base table (regardless of table size). Can be adhered to the leg and will default to the finish of the leg. If additional wire management channels are required, they can be purchased separately at the end of the pricelist.
- Center Wire Chase available on two base tables for more robust wire management needs. See page 128.
- If Simplex/Charging USB Power Blocks are specified, they replace the standard Power Blocks on the table. Simplex/Charging USB Power Blocks include one simplex receptacle and one charging USB-A+C.
- Panel, Rectangle, Expandable Rectangle, Metal T-base, and Center Column bases have a removable access panel

### REQUIRED INFORMATION (ORDER CANNOT BE ENTERED WITHOUT THIS INFORMATION)

See appendix pages vi-vii for surface material options.

- Choose Glass Finish: Gloss Glass only
- Choose Wood Species & Finish
- Choose Metal Finish. Clear Anodized (-CA) not available on T-Base or Hoop Base.
- Choose Paint Finish, if **-PP**, **-PR**, **-PX** or **-CRP** bases are selected





# VENEER TOP WITH HARDWOOD EDGE / GLASS DOOR POWER ISLAND

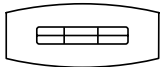

FLOW XT BOAT TOP

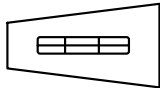

FLOW XT SIGHT LINE TOP

**BASE KEY**

PP Painted Panel  
 PR Painted Rectangle  
 PX Painted Expandable Rectangle

TB Metal T-Base  
 P4 Metal Four Post with Painted Center Column  
 V4 Metal Four Post with Veneer Center Column  
 HP Metal Hoop

VP Veneer Panel  
 VR Veneer Rectangle  
 VX Veneer Expanded Rectangle

**BOAT TABLES**

MODEL #	L x W	BASE QTY	TOP SECTIONS	SEATING CAPACITY	-PP	-PR	-PX	-TB	-P4	-V4	-HP	-VP	-VR	-VX
FWGB-9648-V	96 x 36/48	2	2	8	25,343	26,619	27,100	25,875	26,619	27,100	27,100	25,868	27,100	27,610
FWGB-10248-V	102 x 36/48	2	2	8	27,135	28,482	28,990	27,697	28,482	28,990	28,990	27,689	28,990	29,529
FWGB-10848-V	108 x 36/48	2	2	10	28,512	29,859	30,367	29,074	29,859	30,367	30,367	29,067	30,367	30,906
FWGB-11450-V	114 x 36/50	2	2	10	30,949	32,430	32,988	31,567	32,430	32,988	32,988	31,558	32,988	33,580
FWGB-12050-V	120 x 36/50	2	2	10	32,362	33,842	34,401	32,979	33,842	34,401	34,401	32,971	34,401	34,993
FWGB-13254-V	132 x 36/54	2	2	10	36,103	37,645	38,227	36,746	37,645	38,227	38,227	36,737	38,227	38,844
FWGB-14454-V	144 x 36/54	2	2	12	39,485	41,089	41,693	40,154	41,089	41,693	41,693	40,145	41,693	42,335
FWGB-15654-V	156 x 36/54	3	2	12	44,936	47,366	48,283	45,950	47,366	48,283	48,283	45,936	48,283	49,255
FWGB-16860-V	168 x 42/60	3	2	14	49,836	52,395	53,361	50,903	52,395	53,361	53,361	50,889	53,361	54,385
FWGB-18060-V	180 x 42/60	3	2	14	52,963	55,522	56,488	54,030	55,522	56,488	56,488	54,016	56,488	57,512
FWGB-19272-V	192 x 54/72	3	3	18	63,019	65,733	66,757	-	65,733	66,757	66,757	64,136	66,757	67,843
FWGB-20472-V	204 x 54/72	3	3	18	67,688	70,513	71,579	-	70,513	71,579	71,579	68,850	71,579	72,709
FWGB-21672-V	216 x 54/72	3	3	20	72,007	74,901	75,992	-	74,901	75,992	75,992	73,198	75,992	77,150
FWGB-22872-V	228 x 54/72	3	3	20	75,914	78,835	79,937	-	78,835	79,937	79,937	77,116	79,937	81,106
FWGB-24072-V	240 x 54/72	3	3	20	79,914	82,869	83,983	-	82,869	83,983	83,983	81,130	83,983	85,165

**SIGHT LINE TABLES**

MODEL #	L x W	BASE QTY	TOP SECTIONS	SEATING CAPACITY	-PP	-PR	-PX	-TB	-P4	-V4	-HP	-VP	-VR	-VX
FWGA-9660-V	96 x 36/60	2	2	9	27,031	28,434	28,964	27,616	-	-	28,964	27,608	28,964	29,525
FWGA-10260-V	102 x 36/60	2	2	9	29,004	30,486	31,044	29,622	-	-	31,044	29,614	31,044	31,637
FWGA-10860-V	108 x 36/60	2	2	11	30,470	31,951	32,510	31,088	-	-	32,510	31,080	32,510	33,103
FWGA-11460-V	114 x 36/60	2	2	11	32,500	34,059	34,647	33,150	-	-	34,647	33,141	34,647	35,271
FWGA-12066-V	120 x 36/66	2	2	11	37,277	38,931	39,554	37,967	-	-	39,554	37,957	39,554	40,216
FWGA-13268-V	132 x 36/68	2	3	11	41,483	43,206	43,856	42,202	-	-	43,856	42,192	43,856	44,545
FWGA-14470-V	144 x 36/70	2	3	13	45,857	47,648	48,324	-	-	-	48,324	46,594	48,324	49,041
FWGA-15672-V	156 x 36/72	3	3	13	52,497	55,212	56,236	-	-	-	56,236	53,614	56,236	57,322
FWGA-16876-V	168 x 36/76	3	3	15	56,115	58,752	59,747	-	-	-	59,747	57,200	59,747	60,802
FWGA-18078-V	180 x 36/78	3	3	15	60,083	62,720	63,715	-	-	-	63,715	61,168	63,715	64,769
FWGA-19278-V	192 x 36/78	3	3	17	63,641	66,278	67,273	-	-	-	67,273	64,726	67,273	68,328
FWGA-20478-V	204 x 36/78	3	3	17	68,388	71,133	72,168	-	-	-	72,168	69,517	72,168	73,266
FWGA-21678-V	216 x 36/78	3	3	19	72,779	75,590	76,650	-	-	-	76,650	73,935	76,650	77,775
FWGA-22878-V	228 x 36/78	3	3	19	76,748	79,586	80,657	-	-	-	80,657	77,916	80,657	81,792
FWGA-24078-V	240 x 36/78	3	3	19	80,813	83,683	84,766	-	-	-	84,766	81,994	84,766	85,914



# VENEER TOP WITH HARDWOOD EDGE / GLASS DOOR POWER ISLAND

OPTIONS	CODE	PRICE	NOTES
<b>Power Island Storage Module Options:</b>			
One storage module in the center of the Power Island	Add <b>-SM47</b>		
One storage module at each end of the Power Island	Add <b>-SM43</b>		Only available on tables 144" and longer
One storage module in the center and one at each end of the Power Island	Add <b>-SM44</b>		Only available on tables 192" and longer
<b>Simplex/Charging USB Power Block Options:</b>			
Tables standard with (4) Power Blocks	Add <b>-CHPBC4</b>	\$457	
Tables standard with (8) Power Blocks	Add <b>-CHPBC8</b>	\$912	
Field-Wired:	Add <b>-FW</b>		Deduct \$641 per table
Plug-in Infeed (20-amp):	Add <b>-PI</b>	\$61	
<b>Center Column Base Finish Options:</b>			
Veneer Center Column Base*	Add <b>-CRV</b>	No Charge	To replace existing middle base (Hoop Base and T-Base only)
Painted Center Column Base*	Add <b>-CRP</b>	No Charge	To replace existing middle base (Hoop Base and T-Base only)
<b>Polished Chrome Finish Options:</b>			
Polished Chrome Four Post Base	Add <b>-PCFB</b>	\$2,558	*When specifying -CRV or -CRP in conjunction with a Polished Chrome finish on Hoop Base or T-Base tables with 3 bases, use the upcharge code and pricing for 2 base tables (-PCH2 or -PCTB2).
Polished Chrome Hoop Base (on 2 base tables)	Add <b>-PCHP2</b>	\$2,558	
Polished Chrome Hoop Base (on 3 base tables)	Add <b>-PCHP3</b>	\$3,835	
Polished Chrome T-Base (on 2 base tables)	Add <b>-PCTB2</b>	\$2,558	
Polished Chrome T-Base (on 3 base tables)	Add <b>-PCTB3</b>	\$3,835	
T-Base Combination Finish (on 2 base tables)	Add <b>-PCCBF2</b>	\$1,566	
T-Base Combination Finish (on 3 base tables)	Add <b>-PCCBF3</b>	\$2,349	
<b>Multi-Section Tops:</b>			
204", 216", 228" or 240" two-piece tops split into three sections	Specify -3	\$1,140	

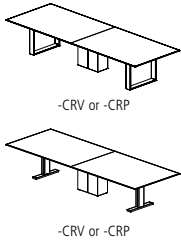

## EDGE PROFILE

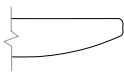

Reverse Flow Edge

## GENERAL INFORMATION

- Storage Modules, if specified, will have metal doors
- Tops are 1-1/8"-thick with 3/16"-deep hardwood edge band
- Seating capacity based on 27" per person
- Four Post Base includes a 12"x24" center column for wire management. Center column may be removed from tables 96" and shorter with options -4COLP or -4COLV above. On tables over 96", the center column is required for support.
- T-Base combination finish includes a Polished Chrome foot and Powder Coat vertical column
- Beam finish will match Metal Finish selection. If no Metal Finish is selected, beams will be Foil.
- If Polished Chrome Finish is specified on the T-Base or Hoop Base, the beams will be Foil. If Polished Chrome Finish is specified on the Four Post Base, the beams will be Clear Anodized.
- Overall table height 29.5"
- Power Island defaults to hardwire infeed option. Specify -PI for plug-in infeed option. Plug-in power infeed will only utilize one circuit of the two-circuit modular power system. To utilize both circuits, the hardwire power in-feed must be specified.
- Tables with three Hoop or T-Bases will default to the same base style for all three bases. An alternate Center Column Base may also be specified above.
- One wire manager included with the Hoop Base table (regardless of table size). Can be adhered to the leg and will default to the finish of the leg. If additional wire management channels are required, they can be purchased separately at the end of the pricelist.
- Center Wire Chase available on two base tables for more robust wire management needs. See page 128.
- If Simplex/Charging USB Power Blocks are specified, they replace the standard Power Blocks on the table. Simplex/Charging USB Power Blocks include one simplex receptacle and one charging USB-A+C.
- Panel, Rectangle, Expandable Rectangle, Metal T-base, and Center Column bases have a removable access panel



### REQUIRED INFORMATION (ORDER CANNOT BE ENTERED WITHOUT THIS INFORMATION)

See appendix pages vi-vii for surface material options.

- Choose Glass Finish: Gloss Glass only
- Choose Wood Species & Finish
- Choose Metal Finish. Clear Anodized (-CA) not available on T-Base or Hoop Base.
- Choose Paint Finish, if **-PP**, **-P4**, **-PR**, **-PX** or **-CRP** bases are selected

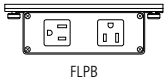

# POWER AND DATA OPTIONS

POWER BLOCK	MODEL #	W x D x H	DESCRIPTION	PRICE
 <p>FLPB</p>	FLPB	5 x 1-1/2 x 1-3/4	Power Block, Two Simplex Receptacles	443
	FLPB-USB-C	5 x 1-1/2 x 1-3/4	Power Block, One Simplex Receptacle and One Charging USB-A+C	539
 <p>FLPB-USB-C</p>	OPTIONS			
	OPTIONS	CODE	PRICE	NOTES
Field-Wired	Add <b>-FW</b>	Deduct \$43 per unit	May be required in New York City, Chicago and San Francisco. Check with an electrician for local codes and requirements.	

### GENERAL INFORMATION

- Available in Clear and Black Anodized
- Includes direct plug-in power cord
- Retrofittable into any Flow Power Island
- UL Listed
- See page 10 for more information on Power Blocks

**REQUIRED INFORMATION: (ORDER CANNOT BE ENTERED WITHOUT THIS INFORMATION)**

- See appendix pages vi-vii for surface material options.
- Choose Metal Finish: Clear Anodized (-CA) or Black Anodized (-BA)

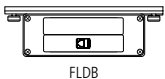
DATA BLOCK	MODEL #	W x D x H	DESCRIPTION	PRICE
 <p>FLDB</p>	FLDB	5 x 1-1/2 x 1-3/4	Data Block	395

### GENERAL INFORMATION

- Available in Clear and Black Anodized
- Includes one blank AAP faceplate and one RJ-45 AAP faceplate
- Retrofittable into any Flow Power Island
- See page 10 for more information on Power Blocks

**REQUIRED INFORMATION: (ORDER CANNOT BE ENTERED WITHOUT THIS INFORMATION)**

- See appendix pages vi-vii for surface material options.
- Choose Metal Finish: Clear Anodized (-CA) or Black Anodized (-BA)

DATA FACEPLATES	MODEL #	DESCRIPTION	STYLE	W x H	PRICE
FLDF-1	Blank faceplate, single height	Single	3-1/2 x 5/8	74	
FLDF-2	One VGA 15-pin HD Female to Female Gender Changer, one 3.5mm Stereo Mini Jack to Solder Tabs	Single	3-1/2 x 5/8	259	
FLDF-3	One VGA 15-pin HD Female to Female Gender Changer	Single	3-1/2 x 5/8	203	
FLDF-4	One RJ-11 Female to Punch Down - Phone	Single	3-1/2 x 5/8	203	
FLDF-5	One RJ-45 Female to Female Barrel - Data	Single	3-1/2 x 5/8	166	
FLDF-6	Two RJ-45 Female to Female Barrels, single height	Single	3-1/2 x 5/8	223	
FLDF-7	Two RJ-45 Female to Punch Down for CAT 6 - AMP	Single	3-1/2 x 5/8	315	
FLDF-8	Two RJ-45 Female to Punch Down for CAT 6 - Leviton	Single	3-1/2 x 5/8	315	
FLDF-10	Two RJ-45 Female to Punch Down for CAT 6 - Panduit	Single	3-1/2 x 5/8	315	
FLDF-11	Two USB A Female to Two USB A Female on 10" Pigtailed	Single	3-1/2 x 5/8	352	
FLDF-12	Blank faceplate, double height	Double	3-1/2 x 1-3/8	92	
FLDF-13	Two RJ-45 Female to Female Barrels, double height	Double	3-1/2 x 1-3/8	223	
FLDF-14	Cable Pass-Through Set - one top, one bottom	Double	3-1/2 x 1-3/8	389	
FLDF-15	One HDMI Female to Female Barrel	Single	3-1/2 x 5/8	259	

### GENERAL INFORMATION

- All connectors and faceplates are Extron® Architectural Adapter Plates (AAP)
- Faceplates are black



# VENEER TOP WITH HARDWOOD EDGE



ROUND TOP

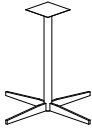

METAL X-BASE  
-XB



CYLINDER BASE  
-PCB and -VCB

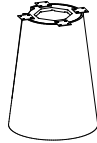

CONE BASE  
-PCN and -VCN

### BASE KEY

- XB Metal X-Base
- PCB Painted Cylinder Base
- VCB Veneer Cylinder Base
- PCN Painted Cone Base
- VCN Veneer Cone Base

### ROUND TABLES

MODEL #	DIAMETER	BASE QTY	TOP SECTIONS	SEATING CAPACITY	-XB	-PCB	-VCB	-PCN	-VCN
FWNR-36-V	36	1	1	3	3,093	4,005	4,213	4,005	4,213
FWNR-42-V	42	1	1	4	3,440	4,352	4,560	4,352	4,560
FWNR-48-V	48	1	1	5	4,261	5,274	5,504	5,274	5,504
FWNR-54-V	54	1	1	6	5,264	6,382	6,638	6,382	6,638
FWNR-60-V	60	1	1	6	6,247	7,434	7,705	7,434	7,705
FWNR-66-V	66	1	2	6	-	9,534	9,808	9,534	9,808
FWNR-72-V	72	1	2	8	-	10,500	10,774	10,500	10,774
FWNR-84-V	84	1	2	8	-	12,685	12,959	12,685	12,959

### OPTIONS

Polished Chrome Metal X-Base Finish  
Power & Data Options

### CODE

Add **-PCCH**

### PRICE

\$547

### NOTES

See pages 119 and 123-129 (only available on Cone and Cylinder Bases)

### EDGE PROFILE



Reverse Flow Edge

### GENERAL INFORMATION

- Tops are 1-1/8"-thick with 3/16"-deep hardwood edge band
- Seating capacity based on 27" per person
- Overall table height 29-1/2"
- No power options are available on the Metal X-Base
- Metal X-Bases are not wire management capable
- Cone Base and Cylinder Base includes access panel
- 36", 42", 48", 54", and 60" tables with the Cone Base can only accept the Power Matrix Compact unit at center (no other Power Matrix sizes)
- When specified with Power Matrix or Tech Node, 66", 72", and 84" tables with the Cylinder Base or Cone Base will have two units, one on each side of the table top seam. Must specify two units per table.
- The Cone Base table can only accept one Tech Node unit at center on a 60" table
- The Cone Base table can only accept a Compact Power Matrix

### REQUIRED INFORMATION (ORDER CANNOT BE ENTERED WITHOUT THIS INFORMATION)

See appendix pages vi-vii for surface material options.

- Choose Metal Finish. Upcharge applies for Polished Chrome (-PCCH) option.
- Choose Veneer Finish
- Choose Paint Finish, if -PCN or -PCB base is selected



# PLANK VENEER TOP WITH HARDWOOD EDGE



ROUND TOP

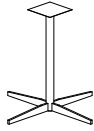

METAL X-BASE  
-XB



CYLINDER BASE  
-PCB and -VCB



CONE BASE  
-PCN and -VCN

### BASE KEY

- XB Metal X-Base
- PCB Painted Cylinder Base
- VCB Veneer Cylinder Base
- PCN Painted Cone Base
- VCN Veneer Cone Base

### ROUND TABLES

MODEL #	DIAMETER	BASE QTY	TOP SECTIONS	SEATING CAPACITY	-XB	-PCB	-VCB	-PCN	-VCN
FWNR-36-PW	36	1	1	3	3,557	4,606	4,845	4,606	4,845
FWNR-42-PW	42	1	1	4	3,956	5,005	5,244	5,005	5,244
FWNR-48-PW	48	1	1	5	4,901	6,066	6,330	6,066	6,330
FWNR-54-PW	54	1	1	6	6,054	7,340	7,634	7,340	7,634
FWNR-60-PW	60	1	1	6	7,185	8,550	8,861	8,550	8,861
FWNR-66-PW	66	1	2	6	-	10,965	11,280	10,965	11,280
FWNR-72-PW	72	1	2	8	-	12,075	12,391	12,075	12,391
FWNR-84-PW	84	1	2	8	-	14,588	14,903	14,588	14,903

### OPTIONS

Polished Chrome Metal X-Base Finish  
Power & Data Options

### CODE

Add **-PCCH**

### PRICE

\$547

### NOTES

See pages 119 and 123-129 (only available on Cone and Cylinder Bases)

### EDGE PROFILE



Reverse Flow Edge

### GENERAL INFORMATION

- Tops are 1-1/8"-thick with 3/16"-deep hardwood edge band
- Seating capacity based on 27" per person
- Overall table height 29-1/2"
- No power options are available on the Metal X-Base
- Metal X-Bases are not wire management capable
- Cone Base and Cylinder Base includes access panel
- 36", 42", 48", 54", and 60" tables with the Cone Base can only accept the Power Matrix Compact unit at center (no other Power Matrix sizes)
- When specified with Power Matrix or Tech Node, 66", 72", and 84" tables with the Cylinder Base or Cone Base will have two units, one on each side of the table top seam. Must specify two units per table.
- Veneer base will default to flat-cut (non-plank) clear coat walnut and remain in vertical slip-match lay-up. Clear coat finish captures color variation to complement the variation of the plank door style.
- The Cone Base table can only accept one Tech Node unit at center on a 60" table.
- The Cone Base table can only accept a Compact Power Matrix

### REQUIRED INFORMATION (ORDER CANNOT BE ENTERED WITHOUT THIS INFORMATION)

See appendix pages vi-vii for surface material options.

- Choose Metal Finish. Upcharge applies for Polished Chrome (-PCCH) option.
- Choose Paint Finish, if -PCN or -PCB base is selected



# INSET LAMINATE TOP WITH HARDWOOD EDGE



ROUND TOP

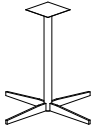

METAL X-BASE  
-XB



CYLINDER BASE  
-PCB and -VCB

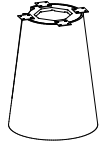

CONE BASE  
-PCN and -VCN

**BASE KEY**

- XB Metal X-Base
- PCB Painted Cylinder Base
- VCB Veneer Cylinder Base
- PCN Painted Cone Base
- VCN Veneer Cone Base

**ROUND TABLES**

MODEL #	DIAMETER	BASE QTY	TOP SECTIONS	SEATING CAPACITY	-XB	-PCB	-VCB	-PCN	-VCN
FWNR-36-V-P	36	1	1	3	2,923	3,785	3,982	3,785	3,982
FWNR-42-V-P	42	1	1	4	3,251	4,113	4,310	4,113	4,310
FWNR-48-V-P	48	1	1	5	4,027	4,984	5,202	4,984	5,202
FWNR-54-V-P	54	1	1	6	4,975	6,031	6,273	6,031	6,273
FWNR-60-V-P	60	1	1	6	5,904	7,026	7,282	7,026	7,282
FWNR-66-V-P	66	1	2	6	-	9,010	9,269	9,010	9,269
FWNR-72-V-P	72	1	2	8	-	9,923	10,182	9,923	10,182
FWNR-84-V-P	84	1	2	8	-	11,988	12,247	11,988	12,247

**OPTIONS**

Polished Chrome Metal X-Base Finish  
Power & Data Options

**CODE**

Add **-PCCH**

**PRICE**

\$547

**NOTES**

See pages 119 and 123-129 (only available on Cone and Cylinder Bases)

**EDGE PROFILE**

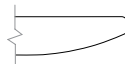

Reverse Flow Edge

**GENERAL INFORMATION**

- Tops are 1-1/8"-thick with 3/16"-deep hardwood edge band
- Seating capacity based on 27" per person
- Overall table height 29-1/2"
- No power options are available on the Metal X-Base
- Metal X-Bases are not wire management capable
- Cone Base and Cylinder Base includes access panel
- 36", 42", 48", 54", and 60" tables with the Cone Base can only accept the Power Matrix Compact unit at center (no other Power Matrix sizes)
- When specified with Power Matrix or Tech Node, 66", 72", and 84" tables with the Cylinder Base or Cone Base will have two units, one on each side of the table top seam. Must specify two units per table.
- The Cone Base table can only accept one Tech Node unit at center on a 60" table
- The Cone Base table can only accept a Compact Power Matrix

**REQUIRED INFORMATION (ORDER CANNOT BE ENTERED WITHOUT THIS INFORMATION)**

See appendix pages vi-vii for surface material options.

- Choose Metal Finish. Upcharge applies for Polished Chrome (-PCCH) option.
- Choose Veneer Finish
- Choose Paint Finish, if -PCN or -PCB base is selected
- Choose Laminate



# LAMINATE TOP WITH ABS SQUARE EDGE



ROUND TOP

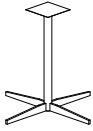

METAL X-BASE  
-XB



CYLINDER BASE  
-PCB and -VCB

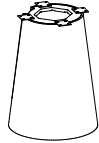

CONE BASE  
-PCN and -VCN

**BASE KEY**

- XB Metal X-Base
- PCB Painted Cylinder Base
- PCN Painted Cone Base

**ROUND TABLES**

MODEL #	DIAMETER	BASE QTY	TOP SECTIONS	SEATING CAPACITY	-XB	-PCB	-PCN
FWNR-36-PE	36	1	1	3	2,774	3,686	3,686
FWNR-42-PE	42	1	1	4	3,076	3,988	3,988
FWNR-48-PE	48	1	1	5	3,798	4,811	4,811
FWNR-54-PE	54	1	1	6	4,680	5,798	5,798
FWNR-60-PE	60	1	1	6	5,542	6,729	6,729
FWNR-66-PE	66	1	2	6	-	8,492	8,492
FWNR-72-PE	72	1	2	8	-	9,323	9,323
FWNR-84-PE	84	1	2	8	-	11,204	11,204

**OPTIONS**

OPTIONS	CODE	PRICE	NOTES
Polished Chrome Metal X-Base Finish Power & Data Options	Add <b>-PCCH</b>	\$547	See pages 119 and 123-129 (only available on Cone and Cylinder Bases)

**EDGE PROFILE**



ABS Square Edge

**GENERAL INFORMATION**

- Tops are 1-1/8"-thick with 2mm ABS edge
- Seating capacity based on 27" per person
- Overall table height 29-1/2"
- No power options are available on the Metal X-Base
- Metal X-Bases are not wire management capable
- Cone Base and Cylinder Base includes access panel
- 36", 42", 48", 54", and 60" tables with the Cone Base can only accept the Power Matrix Compact unit at center (no other Power Matrix sizes)
- When specified with Power Matrix or Tech Node, 66", 72", and 84" tables with the Cylinder Base or Cone Base will have two units, one on each side of the table top seam. Must specify two units per table.
- The Cone Base table can only accept one Tech Node unit at center on a 60" table
- The Cone Base table can only accept a Compact Power Matrix

**REQUIRED INFORMATION (ORDER CANNOT BE ENTERED WITHOUT THIS INFORMATION)**

- See appendix pages vi-vii for surface material options.
- Choose Laminate
  - Choose Metal Finish. Upcharge applies for Polished Chrome (-PCCH) option.
  - Choose ABS Color
  - Choose Paint Finish, if -PCN or -PCB base is selected



# LAMINATE TOP WITH ABS REVERSE EDGE

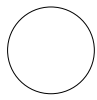

ROUND TOP

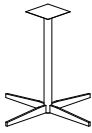

METAL X-BASE  
-XB

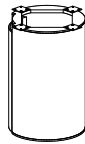

CYLINDER BASE  
-PCB

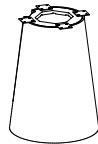

CONE BASE  
-PCN and -VCN

**BASE KEY**

- XB Metal X-Base
- PCB Painted Cylinder Base
- PCN Painted Cone Base

**ROUND TABLES**

MODEL #	DIAMETER	BASE QTY	TOP SECTIONS	SEATING CAPACITY	-XB	-PCB	-PCN
FWNR-36-PA	36	1	1	3	2,923	3,785	3,785
FWNR-42-PA	42	1	1	4	3,251	4,113	4,113
FWNR-48-PA	48	1	1	5	4,027	4,984	4,984
FWNR-54-PA	54	1	1	6	4,975	6,031	6,031
FWNR-60-PA	60	1	1	6	5,904	7,026	7,026
FWNR-66-PA	66	1	2	6	-	9,010	9,010
FWNR-72-PA	72	1	2	8	-	9,923	9,923
FWNR-84-PA	84	1	2	8	-	11,988	11,988

**OPTIONS**

OPTIONS	CODE	PRICE	NOTES
Polished Chrome Metal X-Base Finish Power & Data Options	Add -PCCH	\$547	See pages 119 and 123-129 (only available on Cone and Cylinder Bases)

**EDGE PROFILE**



ABS Reverse Flow Edge

**GENERAL INFORMATION**

- Tops are 1-1/8" thick with 3/16" deep hardwood edge band
- Seating capacity based on 27" per person
- Overall table height 29-1/2"
- No power options are available on the Metal X-Base
- Metal X-Bases are not wire management capable
- Cylinder Base includes hinged access panel
- Underside of table edge is painted to match ABS color
- 36", 42", 48", 54", and 60" tables with the Cone Base can only accept the Power Matrix Compact unit at center (no other Power Matrix sizes)
- When specified with Power Matrix or Tech Node, 66", 72", and 84" tables with the Cylinder Base or Cone Base will have two units, one on each side of the table top seam. Must specify two units per table.
- The Cone Base table can only accept one Tech Node unit at center on a 60" table
- The Cone Base table can only accept a Compact Power Matrix

**REQUIRED INFORMATION (ORDER CANNOT BE ENTERED WITHOUT THIS INFORMATION)**

See appendix pages vi-vii for surface material options.

- Choose Laminate
- Choose Metal Finish. Upcharge applies for Polished Chrome (-PCCH) option.
- Choose ABS Color
- Choose Cylinder Paint Finish, if -PCB base is selected





# GLASS TOP



ROUND TOP

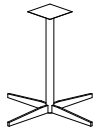

METAL X-BASE  
-XB

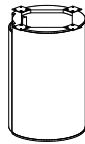

CYLINDER BASE  
-PCB and -VCB



CONE BASE  
-PCN and -VCN

### BASE KEY

- XB Metal X-Base
- PCB Painted Cylinder Base
- VCB Veneer Cylinder Base
- PCN Painted Cone Base
- VCN Veneer Cone Base

## ROUND TABLES

MODEL#	DIAMETER	BASE QTY	TOP SECTIONS	SEATING CAPACITY	-XB	-PCB	-VCB	-PCN	-VCN
FWNR-36-G	36	1	1	3	4,777	5,689	5,897	5,689	5,897
FWNR-42-G	42	1	1	4	5,360	6,272	6,480	6,272	6,480
FWNR-48-G	48	1	1	5	6,695	7,708	7,938	7,708	7,938
FWNR-54-G	54	1	1	6	8,333	9,451	9,707	9,451	9,707
FWNR-60-G	60	1	1	6	9,955	11,142	11,413	11,142	11,413
FWNR-66-G	66	1	2	6	-	14,530	14,804	14,530	14,804
FWNR-72-G	72	1	2	8	-	16,140	16,414	16,140	16,414
FWNR-84-G	84	1	2	8	-	19,780	20,054	19,780	20,054

OPTIONS	CODE	PRICE	NOTES
Satin Glass	Add <b>-RSG</b>	\$382	
Polished Chrome Metal X-Base Finish	Add <b>-PCCH</b>	\$547	
Power & Data Options			See pages 119 and 123-129 (only available on Cone and Cylinder Bases)

## EDGE PROFILE

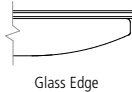

## GENERAL INFORMATION

- Tops are 1-1/8" -thick sub-top with 1/4" -thick back-painted low iron glass
- Seating capacity based on 27" per person
- Overall table height 29-1/2"
- No power options are available on the Metal X-Base
- Metal X-Bases are not wire management capable
- Cone Base and Cylinder Base includes access panel
- Unless otherwise specified, the sub-top finish will match the base finish (specification required when base is polished chrome)
- 36", 42", 48", 54", and 60" tables with the Cone Base can only accept the Power Matrix Compact unit at center (no other Power Matrix sizes)
- When specified with Power Matrix or Tech Node, 66", 72", and 84" tables with the Cylinder Base or Cone Base will have two units, one on each side of the table top seam. Must specify two units per table.
- The Cone Base table can only accept one Tech Node unit at center on a 60" table
- The Cone Base table can only accept a Compact Power Matrix

### REQUIRED INFORMATION (ORDER CANNOT BE ENTERED WITHOUT THIS INFORMATION)

- See appendix pages vi-vii for surface material options.
- Choose Glass Finish (Satin Glass upcharges apply, see options above)
  - Choose Sub-Top Finish:
    - Paint Finish, or
    - Veneer Finish
  - Choose Metal Finish. Upcharge applies for Polished Chrome (-PCCH) option.
  - Choose Wood Species & Finish, if -VCB base is selected
  - Choose Paint Finish, if -PCN or -PCB base is selected



# SOLID SURFACE TOP



ROUND TOP

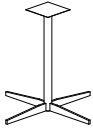

METAL X-BASE  
-XB



CYLINDER BASE  
-PCB and -VCB

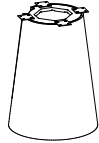

CONE BASE  
-PCN and -VCN

**BASE KEY**

- XB Metal X-Base
- PCB Painted Cylinder Base
- VCB Veneer Cylinder Base
- PCN Painted Cone Base
- VCN Veneer Cone Base

**ROUND TABLES**

MODEL #	DIAMETER	BASE QTY	TOP SECTIONS	SEATING CAPACITY	-XB	-PCB	-VCB	-PCN	-VCN
FWNR-36-SS	36	1	1	3	5,042	6,529	6,868	6,529	6,868
FWNR-42-SS	42	1	1	4	5,608	7,094	7,433	7,094	7,433
FWNR-48-SS	48	1	1	5	6,946	8,597	8,972	8,597	8,972
FWNR-54-SS	54	1	1	6	8,581	10,403	10,820	10,403	10,820
FWNR-60-SS	60	1	1	6	10,183	12,118	12,560	12,118	12,560
FWNR-66-SS	66	1	2	6	-	15,541	15,988	15,541	15,988
FWNR-72-SS	72	1	2	8	-	17,115	17,562	17,115	17,562
FWNR-84-SS	84	1	2	8	-	20,677	21,124	20,677	21,124

OPTIONS	CODE	PRICE	NOTES
Polished Chrome Metal X-Base Finish Power & Data Options	Add -PCCH	\$547	See pages 119 and 123-129 (only available on Cone and Cylinder Bases)

**EDGE PROFILE**



Solid Surface Edge

**GENERAL INFORMATION**

- Solid surface overhangs the subtop 1" and is 1/2" -thick
- Seating capacity based on 27" per person
- Overall table height 29-1/2"
- No power options are available on the Metal X-Base
- Metal X-Bases are not wire management capable
- Cone Base and Cylinder Base includes access panel
- 36", 42", 48", 54", and 60" tables with the Cone Base can only accept the Power Matrix Compact unit at center (no other Power Matrix sizes)
- When specified with Power Matrix or Tech Node, 66", 72", and 84" tables with the Cylinder Base or Cone Base will have two units, one on each side of the table top seam. Must specify two units per table.
- The Cone Base table can only accept one Tech Node unit at center on a 60" table
- The Cone Base table can only accept a Compact Power Matrix

**REQUIRED INFORMATION (ORDER CANNOT BE ENTERED WITHOUT THIS INFORMATION)**

See appendix pages vi-vii for surface material options.

- Choose Solid Surface Finish
- Choose Metal Finish, if applicable. Upcharge applies for Polished Chrome (-PCCH) option.
- Choose Paint Finish, if -PCB base is selected



# STONE / QUARTZ TOP

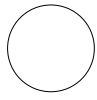

ROUND TOP

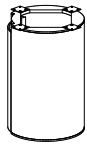

CYLINDER BASE  
-PCB and -VCB



CONE BASE  
-PCN and -VCN

**BASE KEY**

- PCB Painted Cylinder Base
- VCB Veneer Cylinder Base
- PCN Painted Cone Base
- VCN Veneer Cone Base

**ROUND TABLES**

MODEL #	DIAMETER	BASE QTY	TOP SECTIONS	SEATING CAPACITY	-PCB	-VCB	-PCN	-VCN
FWNR-36-S	36	1	1	3	7,690	8,089	7,690	8,089
FWNR-42-S	42	1	1	4	8,356	8,756	8,356	8,756
FWNR-48-S	48	1	1	5	10,127	10,568	10,127	10,568
FWNR-54-S	54	1	1	6	12,254	12,745	12,254	12,745
FWNR-60-S	60	1	2	6	14,274	14,794	14,274	14,794
FWNR-66-S	66	1	2	6	18,306	18,832	18,306	18,832
FWNR-72-S	72	1	2	8	20,160	20,687	20,160	20,687
FWNR-84-S	84	1	2	8	24,356	24,882	24,356	24,882

**OPTIONS**

**CODE**

**PRICE**

**NOTES**

Power & Data Options

See pages 119 and 123-129 (only available on Cone and Cylinder Bases)

**EDGE PROFILE**

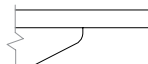

Stone/Quartz Edge

**GENERAL INFORMATION**

- Tops are 2cm thick, cantilevered 3" over a 1-1/8" sub-top
- When Absolute Black Granite stone is specified, the subtop will be painted in Galaxy (S8007)
- When Quartz Carrara Codena or Quartz Serene stone are specified, the subtop will be painted in Cloud (S8004)
- Seating capacity based on 27" per person
- Overall table height is 30" for tables 36"-48" in diameter; 31.25" for tables 54" or larger
- Cone Base and Cylinder Base includes access panel
- 36", 42", 48", 54", and 60" tables with the Cone Base can only accept the Power Matrix Compact unit at center (no other Power Matrix sizes)
- When specified with Power Matrix or Tech Node, 66", 72", and 84" tables with the Cylinder Base or Cone Base will have two units, one on each side of the table top seam. Must specify two units per table.
- The Cone Base table can only accept one Tech Node unit at center on a 60" table
- The Cone Base table can only accept a Compact Power Matrix
- 66" tables with the Cylinder Base can only accept the Power Matrix Compact units (no other Power Matrix sizes)

**REQUIRED INFORMATION (ORDER CANNOT BE ENTERED WITHOUT THIS INFORMATION)**

See appendix pages vi-vii for surface material options.

- Choose Stone/Quartz
- Choose Veneer Finish, if -VCB base is selected
- Choose Paint Finish, if -PCN or -PCB base is selected



# CAFE HEIGHT TOPS AND BASES

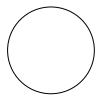

ROUND TOP

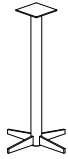

CAFE HEIGHT BASE

### TOP SURFACE MATERIAL KEY

- PE Laminate Top with ABS Edge
- P Inset Laminate Top with Hardwood Edge
- V Veneer
- PW Plank Veneer
- G Glass
- SS Solid Surface

### ROUND TABLES

MODEL #	DIAMETER	HEIGHT	BASE QTY	TOP SECTIONS	SEATING CAPACITY	-PE	-P	-V	-PW	-G	-SS
FWCR-24	24	42	1	1	2	2,212	2,327	2,462	2,832	3,781	4,014
FWCR-27	27	42	1	1	2	2,294	2,418	2,558	2,942	3,955	4,170
FWCR-30	30	42	1	1	3	2,515	2,643	2,796	3,216	4,279	4,558
FWCR-33	33	42	1	1	3	2,782	2,912	3,081	3,544	4,660	5,023
FWCR-36	36	42	1	1	4	2,932	3,073	3,251	3,739	4,935	5,300
FWCR-39	39	42	1	1	4	3,094	3,247	3,435	3,951	5,232	5,600
FWCR-42	42	42	1	1	4	3,268	3,433	3,632	4,177	5,552	5,921

### OPTIONS

OPTIONS	CODE	PRICE	NOTES
Satin Glass	Add <b>-RSG</b>	\$382	
Polished Chrome Metal X-Base Finish	Add <b>-PCCH</b>	\$547	

### EDGE PROFILES

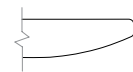

Veneer Edge

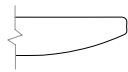

Inset Laminate Top with Hardwood Edge



Laminate Top with ABS Square Edge



Glass Edge

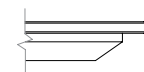

Solid Surface Edge

### GENERAL INFORMATION

- Veneer tops are 1-1/8" -thick with 3/16" -deep hardwood edge band
- Laminate tops are 1-1/8" -thick with 2mm ABS edge
- Inset laminate tops are 1-1/8" -thick with 3/16" deep hardwood edge band
- Glass tops include a 1-1/8" -thick sub-top with 1/4" -thick back-painted low iron glass
- Unless otherwise specified, the sub-top finish will match the base finish (specification required when base is polished chrome)
- Solid surface overhangs the subtop 1" and is 1/2" -thick
- Seating capacity based on 27" per person

### REQUIRED INFORMATION (ORDER CANNOT BE ENTERED WITHOUT THIS INFORMATION)

See appendix pages vi-vii for surface material options.

- Choose Veneer Finish, if specified
- Choose Laminate Finish, if specified
- Choose ABS Edge Finish, if specified
- Choose Glass Finish, if specified
- Choose Sub-Top Finish, if Glass specified:
  - Paint Finish, or
  - Wood Species & Finish
- Choose Solid Surface Finish, if specified
- Choose Metal Finish. Upcharge applies for Polished Chrome (-PCCH) option.



# VENEER TOP WITH HARDWOOD EDGE

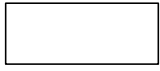

RECTANGLE TOP

### BASE KEY

PP	Painted Panel	TB	Metal T-Base	VP	Veneer Panel
P4	Painted Four Post	HP	Metal Hoop	V4	Veneer Four Post
PR	Painted Rectangle			VR	Veneer Rectangle
PX	Painted Expandable Rectangle			VX	Veneer Expanded Rectangle
PN	Island			VN	Island

### RECTANGLE TABLES

MODEL #	L x W	BASE QTY	TOP SECTIONS	SEATING CAPACITY	-PP	-P4	-PR	-PX	-PN	-TB	-HP	-VP	-V4	-VR	-VX	-VN
FWNT-7236-V	72 x 36	2	1	6	-	5,646	5,646	6,026	-	5,059	-	-	6,026	6,026	6,429	-
FWNT-7242-V	72 x 42	2	1	6	-	6,414	6,414	6,828	-	5,775	-	-	6,828	6,828	7,266	-
FWNT-7842-V	78 x 42	2	1	6	-	7,063	7,063	7,505	-	6,379	-	-	7,505	7,505	7,974	-
FWNT-8442-V	84 x 42	2	1	8	-	7,265	7,265	7,707	-	6,582	-	-	7,707	7,707	8,176	-
FWNT-8448-V	84 x 48	2	1	8	6,657	7,870	7,870	8,328	-	7,163	8,328	7,156	8,328	8,328	8,813	-
FWNT-9042-V	90 x 42	2	1	8	-	7,856	7,856	8,321	-	7,137	-	-	8,321	8,321	8,814	-
FWNT-9048-V	90 x 48	2	1	8	7,251	8,526	8,526	9,008	-	7,783	9,008	7,776	9,008	9,008	9,518	-
FWNT-9642-V	96 x 42	2	1	8	-	8,069	8,069	8,534	-	7,350	-	-	8,534	8,534	9,027	-
FWNT-9648-V	96 x 48	2	1	8	7,498	8,774	8,774	9,255	-	8,030	9,255	8,023	9,255	9,255	9,765	-
FWNT-10242-V	102 x 42	2	1	8	-	8,743	8,743	9,234	-	7,984	-	-	9,234	9,234	9,755	-
FWNT-10248-V	102 x 48	2	1	8	8,175	9,522	9,522	10,030	-	8,737	10,030	8,729	10,030	10,030	10,569	-
FWNT-10842-V	108 x 42	2	1	10	-	8,968	8,968	9,459	-	8,209	-	-	9,459	9,459	9,980	-
FWNT-10848-V	108 x 48	2	1	10	8,436	9,783	9,783	10,291	-	8,998	10,291	8,991	10,291	10,291	10,830	-
FWNT-10854-V	108 x 54	2	1	12	9,341	10,747	10,747	11,278	12,045	9,927	11,278	9,919	11,278	11,278	11,840	12,596
FWNT-11442-V	114 x 42	2	1	10	-	9,677	9,677	10,193	-	8,878	-	-	10,193	10,193	10,741	-
FWNT-11448-V	114 x 48	2	1	10	9,156	10,573	10,573	11,108	-	9,747	11,108	9,739	11,108	11,108	11,675	-
FWNT-11454-V	114 x 54	2	1	12	10,150	11,631	11,631	12,189	12,997	10,768	12,189	10,759	12,189	12,189	12,781	13,577
FWNT-12042-V	120 x 42	2	1	10	-	9,914	9,914	10,431	-	9,116	-	-	10,431	10,431	10,979	-
FWNT-12048-V	120 x 48	2	1	10	9,431	10,848	10,848	11,383	-	10,022	11,383	10,014	11,383	11,383	11,950	-
FWNT-12054-V	120 x 54	2	1	12	10,468	11,948	11,948	12,507	13,315	11,085	12,507	11,077	12,507	12,507	13,099	13,894
FWNT-13248-V	132 x 48	2	2	10	10,396	11,872	11,872	12,429	-	11,012	12,429	11,003	12,429	12,429	13,020	-
FWNT-13254-V	132 x 54	2	2	12	11,566	13,108	13,108	13,690	14,531	12,209	13,690	12,200	13,690	13,690	14,307	15,135
FWNT-14448-V	144 x 48	2	2	12	11,407	12,943	12,943	13,522	-	12,048	13,522	12,039	13,522	13,522	14,136	-
FWNT-14454-V	144 x 54	2	2	14	12,718	14,322	14,322	14,926	15,802	13,387	14,926	13,378	14,926	14,926	15,568	16,430
FWNT-14460-V	144 x 60	2	2	14	14,241	15,930	15,930	16,567	17,489	14,945	16,567	14,936	16,567	16,567	17,243	18,150
FWNT-15648-V	156 x 48	3	2	14	14,417	-	16,744	17,622	-	15,388	17,622	15,374	-	17,622	18,553	-
FWNT-15654-V	156 x 54	3	2	14	15,938	18,368	18,368	19,285	17,734	16,952	19,285	16,938	19,285	19,285	20,257	18,368
FWNT-15660-V	156 x 60	3	2	14	17,712	20,271	20,271	21,237	19,603	18,779	21,237	18,765	21,237	21,237	22,261	20,271
FWNT-16854-V	168 x 54	3	2	16	16,721	19,151	19,151	20,068	18,517	17,734	20,068	17,721	20,068	20,068	21,040	19,151
FWNT-16860-V	168 x 60	3	2	16	18,608	21,167	21,167	22,133	20,499	19,675	22,133	19,661	22,133	22,133	23,157	21,167
FWNT-18054-V	180 x 54	3	2	16	17,503	19,934	19,934	20,850	25,054	18,517	20,850	18,503	20,850	20,850	21,823	26,323
FWNT-18060-V	180 x 60	3	2	16	19,504	22,063	22,063	23,029	27,456	20,571	23,029	20,557	23,029	23,029	24,053	28,792
FWNT-19254-V	192 x 54	3	2	18	18,286	20,717	20,717	21,633	25,837	19,300	21,633	19,286	21,633	21,633	22,605	27,105
FWNT-19260-V	192 x 60	3	2	18	20,400	22,959	22,959	23,925	28,352	21,467	23,925	21,453	23,925	23,925	24,949	29,688
FWNT-19266-V	192 x 66	3	4	18	25,887	28,601	28,601	29,625	34,321	-	29,625	27,004	29,625	29,625	30,711	35,738
FWNT-19272-V	192 x 72	3	4	18	27,330	30,044	30,044	31,068	35,764	-	31,068	28,447	31,068	31,068	32,154	37,181
FWNT-20454-V	204 x 54	3	2	18	19,843	22,372	22,372	23,326	27,700	20,898	23,326	20,884	23,326	23,326	24,338	29,020
FWNT-20460-V	204 x 60	3	2	18	22,159	24,823	24,823	25,828	30,435	23,271	25,828	23,255	25,828	25,828	26,893	31,825
FWNT-20466-V	204 x 66	3	4	18	28,172	30,997	30,997	32,063	36,949	-	32,063	29,334	32,063	32,063	33,193	38,423
FWNT-20472-V	204 x 72	3	4	18	29,768	32,593	32,593	33,659	38,545	-	33,659	30,930	33,659	33,659	34,789	40,019
FWNT-21654-V	216 x 54	3	2	20	21,162	23,753	23,753	24,730	29,211	22,243	24,730	22,228	24,730	24,730	25,766	30,563
FWNT-21660-V	216 x 60	3	2	20	23,655	26,384	26,384	27,413	32,132	24,793	27,413	24,778	27,413	27,413	28,505	33,556
FWNT-21666-V	216 x 66	3	4	20	30,124	33,018	33,018	34,109	39,115	-	34,109	31,315	34,109	34,109	35,267	40,625
FWNT-21672-V	216 x 72	3	4	20	31,856	34,750	34,750	35,841	40,847	-	35,841	33,047	35,841	35,841	36,999	42,357
FWNT-22854-V	228 x 54	3	2	20	22,205	24,821	24,821	25,807	30,331	23,297	25,807	23,282	25,807	25,807	26,854	31,696
FWNT-22860-V	228 x 60	3	2	20	24,845	27,599	27,599	28,638	33,403	25,994	28,638	25,978	28,638	28,638	29,740	34,840
FWNT-22866-V	228 x 66	3	4	20	31,688	34,609	34,609	35,711	40,764	-	35,711	32,890	35,711	35,711	36,880	42,289
FWNT-22872-V	228 x 72	3	4	20	33,533	36,454	36,454	37,556	42,609	-	37,556	34,735	37,556	37,556	38,725	44,134
FWNT-24054-V	240 x 54	3	2	20	23,310	25,955	25,955	26,952	31,527	24,413	26,952	24,398	26,952	26,952	28,010	32,908
FWNT-24060-V	240 x 60	3	2	20	26,101	28,886	28,886	29,937	34,755	27,263	29,937	27,247	29,937	29,937	31,051	36,209
FWNT-24066-V	240 x 66	3	4	20	33,338	36,293	36,293	37,407	42,517	-	37,407	34,554	37,407	37,407	38,589	44,060
FWNT-24072-V	240 x 72	3	4	20	35,302	38,257	38,257	39,371	44,481	-	39,371	36,518	39,371	39,371	40,553	46,024



# VENEER TOP WITH HARDWOOD EDGE

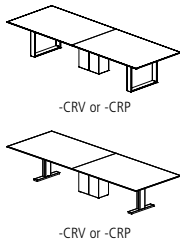

OPTIONS	CODE	PRICE	NOTES
Power and Data Options			See pages 119-129
<b>Remove Center Column for Four Post Base Options:</b>			
If -P4 base is selected	<b>-4COLP</b>	Deduct \$834	Tables 96" and shorter only
If -V4 base is selected	<b>-4COLV</b>	Deduct \$1,286	Tables 96" and shorter only
<b>Center Column Base Finish Options:</b>			
Painted Center Column Base*	Add <b>-CRP</b>	No Charge	To replace existing middle base (Hoop Base and T-Base only)
Veneer Center Column Base*	Add <b>-CRV</b>	No Charge	To replace existing middle base (Hoop Base and T-Base only)
<b>Polished Chrome Finish Options:</b>			
Polished Chrome Four Post Base	Add <b>-PCFB</b>	\$2,558	*When specifying -CRV or -CRP in conjunction with a Polished Chrome finish on Hoop Base or T-Base tables with 3 bases, use the upcharge code and pricing for 2 base tables (-PCHP2 or -PCTB2).
Polished Chrome Hoop Base (on 2 base tables)	Add <b>-PCHP2</b>	\$2,558	
Polished Chrome Hoop Base (on 3 base tables)	Add <b>-PCHP3</b>	\$3,835	
Polished Chrome T-Base (on 2 base tables)	Add <b>-PCTB2</b>	\$2,558	
Polished Chrome T-Base (on 3 base tables)	Add <b>-PCTB3</b>	\$3,835	
T-Base Combination Finish (on 2 base tables)	Add <b>-PCCBF2</b>	\$1,566	
T-Base Combination Finish (on 3 base tables)	Add <b>-PCCBF3</b>	\$2,349	
<b>Multi-Section Tops:</b>			
102", 108", 114" and 120" one-piece tops split into two sections	Specify -2	\$761	Note: Power Matrix (center of table location only) cannot be specified when this option is selected
204", 216", 228" or 240" two-piece tops split into four sections	Specify -4	\$1,517	

## EDGE PROFILE



Reverse Flow Edge

## GENERAL INFORMATION

- Tops are 1-1/8" thick with 3/16" deep hardwood edge band
- Seating capacity based on 27" per person
- Overall table height 29.5"
- Four Post Base includes a 12"x24" center column for wire management. Center column may be removed from tables 96" and shorter with options -4COLP or -4COLV above. On tables over 96", the center column is required for support.
- T-Base combination finish includes a Polished Chrome foot and Powder Coat vertical column
- Beam finish will match Metal Finish selection. If no Metal Finish is selected, beams will be Foil.
- If Polished Chrome Finish is specified on the T-Base or Hoop Base, the beams will be Foil. If Polished Chrome Finish is specified on the Four Post Base, the beams will be Clear Anodized.
- Tables with three Hoop or T-Bases will default to the same base style for all three bases. An alternate Center Column Base may also be specified above.
- One wire manager included with the Hoop Base table (regardless of table size). Can be adhered to the leg and will default to the finish of the leg. If additional wire management channels are required, they can be purchased separately at the end of the pricelist.
- Center Wire Chase available on two base tables for more robust wire management needs. See page 128.
- Panel, Rectangle, Expandable Rectangle, Island, Metal T-base, and Center Column bases have a removable access panel

### REQUIRED INFORMATION (ORDER CANNOT BE ENTERED WITHOUT THIS INFORMATION)

See appendix pages vi-vii for surface material options.

- Choose Veneer Finish
- Choose Metal Finish. Clear Anodized (-CA) not available on T-Base or Hoop Base.
- Choose Paint Finish, if -PP, -P4, -PR, -PX, -PN or -CRP bases are selected



# VENEER TOP WITH HARDWOOD EDGE

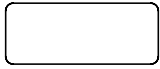

RADIUS RECTANGLE TOP

**BASE KEY**

PP	Painted Panel	TB	Metal T-Base	VP	Veneer Panel
PR	Painted Rectangle	HP	Metal Hoop	VR	Veneer Rectangle
PX	Painted Expandable Rectangle			VX	Veneer Expanded Rectangle
PN	Island			VN	Island

**RADIUS RECTANGLE TABLES**

MODEL #	L x W	BASE QTY	TOP SECTIONS	SEATING CAPACITY	-PP	-PR	-PX	-PN	-TB	-HP	-VP	-VR	-VX	-VN
FWNC-7236-V	72 x 36	2	1	6	-	5,646	6,026	-	5,059	-	-	6,026	6,429	-
FWNC-7242-V	72 x 42	2	1	6	-	6,414	6,828	-	5,775	-	-	6,828	7,266	-
FWNC-7842-V	78 x 42	2	1	6	-	7,063	7,505	-	6,379	-	-	7,505	7,974	-
FWNC-8442-V	84 x 42	2	1	8	-	7,265	7,707	-	6,582	-	-	7,707	8,176	-
FWNC-8448-V	84 x 48	2	1	8	6,657	7,870	8,328	-	7,163	8,328	7,156	8,328	8,813	-
FWNC-9042-V	90 x 42	2	1	8	-	7,856	8,321	-	7,137	-	-	8,321	8,814	-
FWNC-9048-V	90 x 48	2	1	8	7,251	8,526	9,008	-	7,783	9,008	7,776	9,008	9,518	-
FWNC-9642-V	96 x 42	2	1	8	-	8,069	8,534	-	7,350	-	-	8,534	9,027	-
FWNC-9648-V	96 x 48	2	1	8	7,498	8,774	9,255	-	8,030	9,255	8,023	9,255	9,765	-
FWNC-10242-V	102 x 42	2	1	8	-	8,743	9,234	-	7,984	-	-	9,234	9,755	-
FWNC-10248-V	102 x 48	2	1	8	8,175	9,522	10,030	-	8,737	10,030	8,729	10,030	10,569	-
FWNC-10842-V	108 x 42	2	1	10	-	8,968	9,459	-	8,209	-	-	9,459	9,980	-
FWNC-10848-V	108 x 48	2	1	10	8,436	9,783	10,291	-	8,998	10,291	8,991	10,291	10,830	-
FWNC-10854-V	108 x 54	2	1	12	9,341	10,747	11,278	12,045	9,927	11,278	9,919	11,278	11,840	12,596
FWNC-11442-V	114 x 42	2	1	10	-	9,677	10,193	-	8,878	-	-	10,193	10,741	-
FWNC-11448-V	114 x 48	2	1	10	9,156	10,573	11,108	-	9,747	11,108	9,739	11,108	11,675	-
FWNC-11454-V	114 x 54	2	1	12	10,150	11,631	12,189	12,997	10,768	12,189	10,759	12,189	12,781	13,577
FWNC-12042-V	120 x 42	2	1	10	-	9,914	10,431	-	9,116	-	-	10,431	10,979	-
FWNC-12048-V	120 x 48	2	1	10	9,431	10,848	11,383	-	10,022	11,383	10,014	11,383	11,950	-
FWNC-12054-V	120 x 54	2	1	12	10,468	11,948	12,507	13,315	11,085	12,507	11,077	12,507	13,099	13,894
FWNC-13248-V	132 x 48	2	2	10	10,396	11,872	12,429	-	11,012	12,429	11,003	12,429	13,020	-
FWNC-13254-V	132 x 54	2	2	12	11,566	13,108	13,690	14,531	12,209	13,690	12,200	13,690	14,307	15,135
FWNC-14448-V	144 x 48	2	2	12	11,407	12,943	13,522	-	12,048	13,522	12,039	13,522	14,136	-
FWNC-14454-V	144 x 54	2	2	14	12,718	14,322	14,926	15,802	13,387	14,926	13,378	14,926	15,568	16,430
FWNC-14460-V	144 x 60	2	2	14	14,241	15,930	16,567	17,489	14,945	16,567	14,936	16,567	17,243	18,150
FWNC-15648-V	156 x 48	3	2	14	14,417	16,744	17,622	-	15,388	17,622	15,374	17,622	18,553	-
FWNC-15654-V	156 x 54	3	2	14	15,938	18,368	19,285	17,734	16,952	19,285	16,938	19,285	20,257	18,368
FWNC-15660-V	156 x 60	3	2	14	17,712	20,271	21,237	19,603	18,779	21,237	18,765	21,237	22,261	20,271
FWNC-16854-V	168 x 54	3	2	16	16,721	19,151	20,068	18,517	17,734	20,068	17,721	20,068	21,040	19,151
FWNC-16860-V	168 x 60	3	2	16	18,608	21,167	22,133	20,499	19,675	22,133	19,661	22,133	23,157	21,167
FWNC-18054-V	180 x 54	3	2	16	17,503	19,934	20,850	25,054	18,517	20,850	18,503	20,850	21,823	26,323
FWNC-18060-V	180 x 60	3	2	16	19,504	22,063	23,029	27,456	20,571	23,029	20,557	23,029	24,053	28,792
FWNC-19254-V	192 x 54	3	2	18	18,286	20,717	21,633	25,837	19,300	21,633	19,286	21,633	22,605	27,105
FWNC-19260-V	192 x 60	3	2	18	20,400	22,959	23,925	28,352	21,467	23,925	21,453	23,925	24,949	29,688
FWNC-19266-V	192 x 66	3	4	18	25,887	28,601	29,625	34,321	-	29,625	27,004	29,625	30,711	35,738
FWNC-19272-V	192 x 72	3	4	18	27,330	30,044	31,068	35,764	-	31,068	28,447	31,068	32,154	37,181
FWNC-20454-V	204 x 54	3	2	18	19,843	22,372	23,326	27,700	20,898	23,326	20,884	23,326	24,338	29,020
FWNC-20460-V	204 x 60	3	2	18	22,159	24,823	25,828	30,435	23,271	25,828	23,255	25,828	26,893	31,825
FWNC-20466-V	204 x 66	3	4	18	28,172	30,997	32,063	36,949	-	32,063	29,334	32,063	33,193	38,423
FWNC-20472-V	204 x 72	3	4	18	29,768	32,593	33,659	38,545	-	33,659	30,930	33,659	34,789	40,019
FWNC-21654-V	216 x 54	3	2	20	21,162	23,753	24,730	29,211	22,243	24,730	22,228	24,730	25,766	30,563
FWNC-21660-V	216 x 60	3	2	20	23,655	26,384	27,413	32,132	24,793	27,413	24,778	27,413	28,505	33,556
FWNC-21666-V	216 x 66	3	4	20	30,124	33,018	34,109	39,115	-	34,109	31,315	34,109	35,267	40,625
FWNC-21672-V	216 x 72	3	4	20	31,856	34,750	35,841	40,847	-	35,841	33,047	35,841	36,999	42,357
FWNC-22854-V	228 x 54	3	2	20	22,205	24,821	25,807	30,331	23,297	25,807	23,282	25,807	26,854	31,696
FWNC-22860-V	228 x 60	3	2	20	24,845	27,599	28,638	33,403	25,994	28,638	25,978	28,638	29,740	34,840
FWNC-22866-V	228 x 66	3	4	20	31,688	34,609	35,711	40,764	-	35,711	32,890	35,711	36,880	42,289
FWNC-22872-V	228 x 72	3	4	20	33,533	36,454	37,556	42,609	-	37,556	34,735	37,556	38,725	44,134
FWNC-24054-V	240 x 54	3	2	20	23,310	25,955	26,952	31,527	24,413	26,952	24,398	26,952	28,010	32,908
FWNC-24060-V	240 x 60	3	2	20	26,101	28,886	29,937	34,755	27,263	29,937	27,247	29,937	31,051	36,209
FWNC-24066-V	240 x 66	3	4	20	33,338	36,293	37,407	42,517	-	37,407	34,554	37,407	38,589	44,060
FWNC-24072-V	240 x 72	3	4	20	35,302	38,257	39,371	44,481	-	39,371	36,518	39,371	40,553	46,024



# VENEER TOP WITH HARDWOOD EDGE

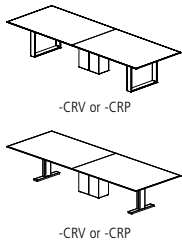

OPTIONS	CODE	PRICE	NOTES
Power and Data Options			See pages 119-129
<b>Remove Center Column for Four Post Base Options:</b>			
If -P4 base is selected	<b>-4COLP</b>	Deduct \$834	Tables 96" and shorter only
If -V4 base is selected	<b>-4COLV</b>	Deduct \$1,286	Tables 96" and shorter only
<b>Center Column Base Finish Options:</b>			
Painted Center Column Base*	Add <b>-CRP</b>	No Charge	To replace existing middle base (Hoop Base and T-Base only)
Veneer Center Column Base*	Add <b>-CRV</b>	No Charge	To replace existing middle base (Hoop Base and T-Base only)
<b>Polished Chrome Finish Options:</b>			
Polished Chrome Hoop Base (on 2 base tables)	Add <b>-PCHP2</b>	\$2,558	*When specifying -CRV or -CRP in conjunction with a Polished Chrome finish on Hoop Base or T-Base tables with 3 bases, use the upcharge code and pricing for 2 base tables (-PCHP2 or -PCTB2).
Polished Chrome Hoop Base (on 3 base tables)	Add <b>-PCHP3</b>	\$3,835	
Polished Chrome T-Base (on 2 base tables)	Add <b>-PCTB2</b>	\$2,558	
Polished Chrome T-Base (on 3 base tables)	Add <b>-PCTB3</b>	\$3,835	
T-Base Combination Finish (on 2 base tables)	Add <b>-PCCBF2</b>	\$1,566	
T-Base Combination Finish (on 3 base tables)	Add <b>-PCCBF3</b>	\$2,349	
<b>Multi-Section Tops:</b>			
102", 108", 114" and 120" one-piece tops split into two sections	Specify -2	\$761	Note: Power Matrix (center of table location only) cannot be specified when this option is selected
204", 216", 228" or 240" two-piece tops split into four sections	Specify -4	\$1,517	

## EDGE PROFILE

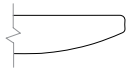

Reverse Flow Edge

## GENERAL INFORMATION

- Tops are 1-1/8" thick with 3/16" deep hardwood edge band
- Seating capacity based on 27" per person
- Overall table height 29.5"
- T-Base combination finish includes a Polished Chrome foot and Powder Coat vertical column
- Beam finish will match Metal Finish selection. If no Metal Finish is selected, beams will be Foil.
- If Polished Chrome Finish is specified on the T-Base or Hoop Base, the beams will be Foil. If Polished Chrome Finish is specified on the Four Post Base, the beams will be Clear Anodized.
- Tables with three Hoop or T-Bases will default to the same base style for all three bases. An alternate Center Column Base may also be specified above.
- One wire manager included with the Hoop Base table (regardless of table size). Can be adhered to the leg and will default to the finish of the leg. If additional wire management channels are required, they can be purchased separately at the end of the pricelist.
- Center Wire Chase available on two base tables for more robust wire management needs. See page 128.
- Panel, Rectangle, Expandable Rectangle, Island, Metal T-base, and Center Column bases have a removable access panel

### REQUIRED INFORMATION (ORDER CANNOT BE ENTERED WITHOUT THIS INFORMATION)

See appendix pages vi-vii for surface material options.

- Choose Veneer Finish
- Choose Metal Finish. Clear Anodized (-CA) not available on T-Base or Hoop Base.
- Choose Paint Finish, if -PP, -PR, -PX, -PN or -CRP bases are selected





# VENEER TOP WITH HARDWOOD EDGE

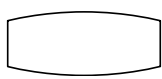

BOAT TOP

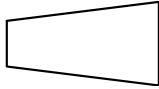

SIGHT LINE TOP

**BASE KEY**

PP Painted Panel  
 P4 Painted Four Post  
 PR Painted Rectangle  
 PX Painted Expandable Rectangle

TB Metal T-Base  
 HP Metal Hoop

VP Veneer Panel  
 V4 Veneer Four Post  
 VR Veneer Rectangle  
 VX Veneer Expanded Rectangle

**BOAT TABLES**

MODEL #	L x W	BASE QTY	TOP SECTIONS	SEATING CAPACITY	-PP	-P4	-PR	-PX	-TB	-HP	-VP	-V4	-VR	-VX
FWNB-7240-V	72 x 32/40	2	1	6	5,226	6,322	6,322	6,736	5,683	-	5,677	6,736	6,736	7,174
FWNB-7840-V	78 x 32/40	2	1	6	5,784	6,957	6,957	7,399	6,273	-	6,267	7,399	7,399	7,868
FWNB-8444-V	84 x 32/44	2	1	8	6,421	7,634	7,634	8,092	6,927	-	6,920	8,092	8,092	8,577
FWNB-9044-V	90 x 32/44	2	1	8	6,985	8,260	8,260	8,742	7,517	-	7,510	8,742	8,742	9,252
FWNB-9648-V	96 x 36/48	2	1	8	7,498	8,774	8,774	9,255	8,030	9,255	8,023	9,255	9,255	9,765
FWNB-10248-V	102 x 36/48	2	1	8	8,175	9,522	9,522	10,030	8,737	10,030	8,729	10,030	10,030	10,569
FWNB-10848-V	108 x 36/48	2	1	10	8,436	9,783	9,783	10,291	8,998	10,291	8,991	10,291	10,291	10,830
FWNB-11450-V	114 x 36/50	2	1	10	9,758	11,239	11,239	11,797	10,376	11,797	10,367	11,797	11,797	12,389
FWNB-12050-V	120 x 36/50	2	1	10	10,056	11,536	11,536	12,095	10,673	12,095	10,665	12,095	12,095	12,687
FWNB-13254-V	132 x 36/54	2	2	10	11,566	13,108	13,108	13,690	12,209	13,690	12,200	13,690	13,690	14,307
FWNB-14454-V	144 x 36/54	2	2	12	12,718	14,322	14,322	14,926	13,387	14,926	13,378	14,926	14,926	15,568
FWNB-15654-V	156 x 36/54	3	2	12	15,938	18,368	18,368	19,285	16,952	19,285	16,938	19,285	19,285	20,257
FWNB-16860-V	168 x 42/60	3	2	14	18,608	21,167	21,167	22,133	19,675	22,133	19,661	22,133	22,133	23,157
FWNB-18060-V	180 x 42/60	3	2	14	19,504	22,063	22,063	23,029	20,571	23,029	20,557	23,029	23,029	24,053
FWNB-19272-V	192 x 54/72	3	4	18	27,330	30,044	30,044	31,068	-	31,068	28,447	31,068	31,068	32,154
FWNB-20472-V	204 x 54/72	3	4	18	29,768	32,593	32,593	33,659	-	33,659	30,930	33,659	33,659	34,789
FWNB-21672-V	216 x 54/72	3	4	20	31,856	34,750	34,750	35,841	-	35,841	33,047	35,841	35,841	36,999
FWNB-22872-V	228 x 54/72	3	4	20	33,533	36,454	36,454	37,556	-	37,556	34,735	37,556	37,556	38,725
FWNB-24072-V	240 x 54/72	3	4	20	35,302	38,257	38,257	39,371	-	39,371	36,518	39,371	39,371	40,553

**SIGHT LINE TABLES**

MODEL #	L x W	BASE QTY	TOP SECTIONS	SEATING CAPACITY	-PP	-P4	-PR	-PX	-TB	-HP	-VP	-V4	-VR	-VX
FWNA-7254-V	72 x 36/54	2	1	7	6,340	-	7,524	7,971	6,834	7,971	6,827	-	7,971	8,445
FWNA-7856-V	78 x 36/56	2	1	7	7,548	-	8,882	9,385	8,104	9,385	8,096	-	9,385	9,918
FWNA-8458-V	84 x 36/58	2	1	9	7,973	-	9,307	9,810	8,530	9,810	8,522	-	9,810	10,344
FWNA-9060-V	90 x 36/60	2	1	9	8,855	-	10,259	10,788	9,441	10,788	9,433	-	10,788	11,349
FWNA-9660-V	96 x 36/60	2	1	9	9,186	-	10,589	11,119	9,771	11,119	9,763	-	11,119	11,680
FWNA-10260-V	102 x 36/60	2	1	9	10,044	-	11,526	12,084	10,662	12,084	10,654	-	12,084	12,677
FWNA-10860-V	108 x 36/60	2	1	11	10,394	-	11,875	12,434	11,012	12,434	11,004	-	12,434	13,027
FWNA-11460-V	114 x 36/60	2	1	11	11,309	-	12,868	13,456	11,959	13,456	11,950	-	13,456	14,080
FWNA-12066-V	120 x 36/66	2	2	11	14,971	-	16,625	17,248	15,661	17,248	15,651	-	17,248	17,910
FWNA-13268-V	132 x 36/68	2	3	11	16,946	-	18,669	19,319	17,665	19,319	17,655	-	19,319	20,008
FWNA-14470-V	144 x 36/70	2	3	13	19,090	-	20,881	21,557	-	21,557	19,827	-	21,557	22,274
FWNA-15672-V	156 x 36/72	3	3	13	23,499	-	26,214	27,238	-	27,238	24,616	-	27,238	28,324
FWNA-16876-V	168 x 36/76	3	3	15	24,887	-	27,524	28,519	-	28,519	25,972	-	28,519	29,574
FWNA-18078-V	180 x 36/78	3	3	15	26,624	-	29,261	30,256	-	30,256	27,709	-	30,256	31,310
FWNA-19278-V	192 x 36/78	3	4	17	27,952	-	30,589	31,584	-	31,584	29,037	-	31,584	32,639
FWNA-20478-V	204 x 36/78	3	4	17	30,468	-	33,213	34,248	-	34,248	31,597	-	34,248	35,346
FWNA-21678-V	216 x 36/78	3	4	19	32,628	-	35,439	36,499	-	36,499	33,784	-	36,499	37,624
FWNA-22878-V	228 x 36/78	3	4	19	34,367	-	37,205	38,276	-	38,276	35,535	-	38,276	39,411
FWNA-24078-V	240 x 36/78	3	4	19	36,201	-	39,071	40,154	-	40,154	37,382	-	40,154	41,302



# VENEER TOP WITH HARDWOOD EDGE

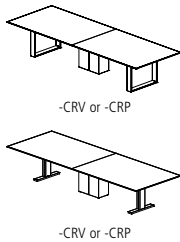

OPTIONS	CODE	PRICE	NOTES
Power and Data Options			See pages 119-129
<b>Remove Center Column for Four Post Base Options:</b>			
If -P4 base is selected	<b>-4COLP</b>	Deduct \$834	Tables 96" and shorter only
If -V4 base is selected	<b>-4COLV</b>	Deduct \$1,286	Tables 96" and shorter only
<b>Center Column Base Finish Options:</b>			
Painted Center Column Base*	Add <b>-CRP</b>	No Charge	To replace existing middle base (Hoop Base and T-Base only)
Veneer Center Column Base*	Add <b>-CRV</b>	No Charge	To replace existing middle base (Hoop Base and T-Base only)
<b>Polished Chrome Finish Options:</b>			
Polished Chrome Hoop Base (on 2 base tables)	Add <b>-PCHP2</b>	\$2,558	*When specifying -CRV or -CRP in conjunction with a Polished Chrome finish on Hoop Base or T-Base tables with 3 bases, use the upcharge code and pricing for 2 base tables (-PCHP2 or -PCTB2).
Polished Chrome Hoop Base (on 3 base tables)	Add <b>-PCHP3</b>	\$3,835	
Polished Chrome T-Base (on 2 base tables)	Add <b>-PCTB2</b>	\$2,558	
Polished Chrome T-Base (on 3 base tables)	Add <b>-PCTB3</b>	\$3,835	
T-Base Combination Finish (on 2 base tables)	Add <b>-PCCBF2</b>	\$1,566	
T-Base Combination Finish (on 3 base tables)	Add <b>-PCCBF3</b>	\$2,349	
<b>Multi-Section Tops:</b>			
102", 108", 114" and 120" one-piece tops split into two sections	Specify -2	\$761	Note: Power Matrix (center of table location only) cannot be specified when this option is selected

## EDGE PROFILE

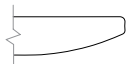

Reverse Flow Edge

## GENERAL INFORMATION

- Tops are 1-1/8" thick with 3/16" deep hardwood edge band
- Seating capacity based on 27" per person
- Overall table height 29.5"
- Four Post Base includes a 12"x24" center column for wire management. Center column may be removed from tables 96" and shorter with options -4COLP or -4COLV above. On tables over 96", the center column is required for support.
- T-Base combination finish includes a Polished Chrome foot and Powder Coat vertical column
- Beam finish will match Metal Finish selection. If no Metal Finish is selected, beams will be Foil.
- If Polished Chrome Finish is specified on the T-Base or Hoop Base, the beams will be Foil. If Polished Chrome Finish is specified on the Four Post Base, the beams will be Clear Anodized.
- Tables with three Hoop or T-Bases will default to the same base style for all three bases. An alternate Center Column Base may also be specified above.
- One wire manager included with the Hoop Base table (regardless of table size). Can be adhered to the leg and will default to the finish of the leg. If additional wire management channels are required, they can be purchased separately at the end of the pricelist.
- Center Wire Chase available on two base tables for more robust wire management needs. See page 128.
- Panel, Rectangle, Expandable Rectangle, Metal T-base, and Center Column bases have a removable access panel

### REQUIRED INFORMATION (ORDER CANNOT BE ENTERED WITHOUT THIS INFORMATION)

See appendix pages vi-vii for surface material options.

- Choose Veneer Finish
- Choose Metal Finish. Clear Anodized (-CA) not available on T-Base or Hoop Base.
- Choose Paint Finish, if -PP, -P4, -PR, -PX or -CRP bases are selected



# PLANK VENEER TOP WITH HARDWOOD EDGE

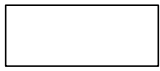

RECTANGLE TOP

### BASE KEY

PP	Painted Panel	TB	Metal T-Base	VP	Veneer Panel
P4	Painted Four Post	HP	Metal Hoop	V4	Veneer Four Post
PR	Painted Rectangle			VR	Veneer Rectangle
PX	Painted Expandable Rectangle			VX	Veneer Expanded Rectangle
PN	Island			VN	Island

### RECTANGLE TABLES

MODEL #	L x W	BASE QTY	TOP SECTIONS	SEATING CAPACITY	-PP	-P4	-PR	-PX	-PN	-TB	-HP	-VP	-V4	-VR	-VX	-VN
FWNT-7236-PW	72 x 36	2	1	6	-	5,334	6,493	6,930	-	5,818	-	-	6,930	6,930	7,394	-
FWNT-7242-PW	72 x 42	2	1	6	-	7,377	7,377	7,853	-	6,642	-	-	7,853	7,853	8,356	-
FWNT-7842-PW	78 x 42	2	1	6	-	8,123	8,123	8,631	-	7,336	-	-	8,631	8,631	9,171	-
FWNT-8442-PW	84 x 42	2	1	8	-	8,355	8,355	8,864	-	7,570	-	-	8,864	8,864	9,403	-
FWNT-8448-PW	84 x 48	2	1	8	7,656	9,051	9,051	9,578	-	8,238	9,578	8,230	9,578	9,578	10,135	-
FWNT-9042-PW	90 x 42	2	1	8	-	9,035	9,035	9,570	-	8,208	-	-	9,570	9,570	10,137	-
FWNT-9048-PW	90 x 48	2	1	8	8,339	9,805	9,805	10,360	-	8,951	10,360	8,943	10,360	10,360	10,946	-
FWNT-9642-PW	96 x 42	2	1	8	-	9,280	9,280	9,815	-	8,453	-	-	9,815	9,815	10,382	-
FWNT-9648-PW	96 x 48	2	1	8	8,623	10,091	10,091	10,644	-	9,235	10,644	9,227	10,644	10,644	11,230	-
FWNT-10242-PW	102 x 42	2	1	8	-	10,055	10,055	10,620	-	9,182	-	-	10,620	10,620	11,219	-
FWNT-10248-PW	102 x 48	2	1	8	9,402	10,951	10,951	11,535	-	10,048	11,535	10,039	11,535	11,535	12,155	-
FWNT-10842-PW	108 x 42	2	1	10	-	10,314	10,314	10,878	-	9,441	-	-	10,878	10,878	11,477	-
FWNT-10848-PW	108 x 48	2	1	10	9,702	11,251	11,251	11,835	-	10,348	11,835	10,340	11,835	11,835	12,455	-
FWNT-10854-PW	108 x 54	2	1	12	10,743	12,360	12,360	12,970	13,852	11,417	12,970	11,407	12,970	12,970	13,616	14,486
FWNT-11442-PW	114 x 42	2	1	10	-	11,129	11,129	11,722	-	10,210	-	-	11,722	11,722	12,353	-
FWNT-11448-PW	114 x 48	2	1	10	10,530	12,159	12,159	12,775	-	11,210	12,775	11,200	12,775	12,775	13,427	-
FWNT-11454-PW	114 x 54	2	1	12	11,673	13,376	13,376	14,018	14,947	12,384	14,018	12,373	14,018	14,018	14,699	15,614
FWNT-12042-PW	120 x 42	2	1	10	-	11,402	11,402	11,996	-	10,484	-	-	11,996	11,996	12,626	-
FWNT-12048-PW	120 x 48	2	1	10	10,846	12,476	12,476	13,091	-	11,526	13,091	11,517	13,091	13,091	13,743	-
FWNT-12054-PW	120 x 54	2	1	12	12,039	13,741	13,741	14,384	15,313	12,748	14,384	12,739	14,384	14,384	15,064	15,979
FWNT-13248-PW	132 x 48	2	2	10	11,956	13,653	13,653	14,294	-	12,664	14,294	12,654	14,294	14,294	14,973	-
FWNT-13254-PW	132 x 54	2	2	12	13,301	15,075	15,075	15,744	16,711	14,041	15,744	14,030	15,744	15,744	16,454	17,406
FWNT-14448-PW	144 x 48	2	2	12	13,119	14,885	14,885	15,551	-	13,856	15,551	13,845	15,551	15,551	16,257	-
FWNT-14454-PW	144 x 54	2	2	14	14,626	16,471	16,471	17,165	18,173	15,396	17,165	15,385	17,165	17,165	17,904	18,895
FWNT-14460-PW	144 x 60	2	2	14	16,378	18,320	18,320	19,053	20,113	17,187	19,053	17,177	19,053	19,053	19,830	20,873
FWNT-15648-PW	156 x 48	3	2	14	16,580	-	19,256	20,266	-	17,697	20,266	17,681	-	20,266	21,336	-
FWNT-15654-PW	156 x 54	3	2	14	18,329	21,124	21,124	22,178	20,395	19,495	22,178	19,479	22,178	22,178	23,296	21,124
FWNT-15660-PW	156 x 60	3	2	14	20,369	23,312	23,312	24,423	22,544	21,596	24,423	21,580	24,423	24,423	25,601	23,312
FWNT-16854-PW	168 x 54	3	2	16	19,230	22,024	22,024	23,079	21,295	20,395	23,079	20,380	23,079	23,079	24,196	22,024
FWNT-16860-PW	168 x 60	3	2	16	21,400	24,343	24,343	25,453	23,574	22,627	25,453	22,611	25,453	25,453	26,631	24,343
FWNT-18054-PW	180 x 54	3	2	16	20,129	22,925	22,925	23,978	28,813	21,295	23,978	21,279	23,978	23,978	25,097	30,272
FWNT-18060-PW	180 x 60	3	2	16	22,430	25,373	25,373	26,484	31,575	23,657	26,484	23,641	26,484	26,484	27,661	33,111
FWNT-19254-PW	192 x 54	3	2	18	21,029	23,825	23,825	24,878	29,713	22,195	24,878	22,179	24,878	24,878	25,996	31,171
FWNT-19260-PW	192 x 60	3	2	18	23,460	26,403	26,403	27,514	32,605	24,688	27,514	24,671	27,514	27,514	28,692	34,142
FWNT-19266-PW	192 x 66	3	4	18	29,771	32,892	32,892	34,069	39,470	-	34,069	31,055	34,069	34,069	35,318	41,099
FWNT-19272-PW	192 x 72	3	4	18	31,430	34,551	34,551	35,729	41,129	-	35,729	32,715	35,729	35,729	36,978	42,759
FWNT-20454-PW	204 x 54	3	2	18	22,820	25,728	25,728	26,825	31,855	24,033	26,825	24,017	26,825	26,825	27,989	33,373
FWNT-20460-PW	204 x 60	3	2	18	25,483	28,547	28,547	29,703	35,001	26,762	29,703	26,744	29,703	29,703	30,927	36,599
FWNT-20466-PW	204 x 66	3	4	18	32,398	35,647	35,647	36,873	42,492	-	36,873	33,735	36,873	36,873	38,172	44,187
FWNT-20472-PW	204 x 72	3	4	18	34,234	37,482	37,482	38,708	44,327	-	38,708	35,570	38,708	38,708	40,008	46,022
FWNT-21654-PW	216 x 54	3	2	20	24,337	27,316	27,316	28,440	33,593	25,580	28,440	25,563	28,440	28,440	29,631	35,148
FWNT-21660-PW	216 x 60	3	2	20	27,204	30,342	30,342	31,525	36,952	28,512	31,525	28,495	31,525	31,525	32,781	38,590
FWNT-21666-PW	216 x 66	3	4	20	34,643	37,971	37,971	39,226	44,983	-	39,226	36,013	39,226	39,226	40,558	46,719
FWNT-21672-PW	216 x 72	3	4	20	36,635	39,963	39,963	41,218	46,975	-	41,218	38,005	41,218	41,218	42,549	48,711
FWNT-22854-PW	228 x 54	3	2	20	25,536	28,545	28,545	29,679	34,881	26,792	29,679	26,775	29,679	29,679	30,883	36,451
FWNT-22860-PW	228 x 60	3	2	20	28,572	31,739	31,739	32,934	38,414	29,894	32,934	29,875	32,934	32,934	34,201	40,066
FWNT-22866-PW	228 x 66	3	4	20	36,442	39,801	39,801	41,068	46,879	-	41,068	37,824	41,068	41,068	42,412	48,633
FWNT-22872-PW	228 x 72	3	4	20	38,563	41,923	41,923	43,190	49,001	-	43,190	39,946	43,190	43,190	44,534	50,755
FWNT-24054-PW	240 x 54	3	2	20	26,807	29,849	29,849	30,995	36,257	28,075	30,995	28,058	30,995	30,995	32,212	37,845
FWNT-24060-PW	240 x 60	3	2	20	30,017	33,219	33,219	34,428	39,969	31,353	34,428	31,335	34,428	34,428	35,709	41,641
FWNT-24066-PW	240 x 66	3	4	20	38,339	41,737	41,737	43,019	48,895	-	43,019	39,738	43,019	43,019	44,378	50,669
FWNT-24072-PW	240 x 72	3	4	20	40,598	43,996	43,996	45,277	51,154	-	45,277	41,996	45,277	45,277	46,636	52,928



# PLANK VENEER TOP WITH HARDWOOD EDGE

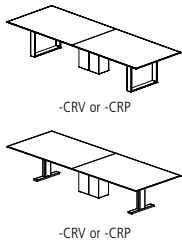

OPTIONS	CODE	PRICE	NOTES
Power and Data Options			See pages 119-129
<b>Remove Center Column for Four Post Base Options:</b>			
If -P4 base is selected	<b>-4COLP</b>	Deduct \$834	Tables 96" and shorter only
If -V4 base is selected	<b>-4COLV</b>	Deduct \$1,286	Tables 96" and shorter only
<b>Center Column Base Finish Options:</b>			
Painted Center Column Base*	Add <b>-CRP</b>	No Charge	To replace existing middle base (Hoop Base and T-Base only)
Veneer Center Column Base*	Add <b>-CRV</b>	No Charge	To replace existing middle base (Hoop Base and T-Base only)
<b>Polished Chrome Finish Options:</b>			
Polished Chrome Four Post Base	Add <b>-PCFB</b>	\$2,558	*When specifying -CRV or -CRP in conjunction with a Polished Chrome finish on Hoop Base or T-Base tables with 3 bases, use the upcharge code and pricing for 2 base tables (-PCHP2 or -PCTB2).
Polished Chrome Hoop Base (on 2 base tables)	Add <b>-PCHP2</b>	\$2,558	
Polished Chrome Hoop Base (on 3 base tables)	Add <b>-PCHP3</b>	\$3,835	
Polished Chrome T-Base (on 2 base tables)	Add <b>-PCTB2</b>	\$2,558	
Polished Chrome T-Base (on 3 base tables)	Add <b>-PCTB3</b>	\$3,835	
T-Base Combination Finish (on 2 base tables)	Add <b>-PCCBF2</b>	\$1,566	
T-Base Combination Finish (on 3 base tables)	Add <b>-PCCBF3</b>	\$2,349	
<b>Multi-Section Tops:</b>			
102", 108", 114" and 120" one-piece tops split into two sections	Specify -2	\$761	Note: Power Matrix (center of table location only) cannot be specified when this option is selected
204", 216", 228" or 240" two-piece tops split into four sections	Specify -4	\$1,517	

## EDGE PROFILE



Reverse Flow Edge

## GENERAL INFORMATION

- Tops are 1-1/8" thick with 3/16" deep hardwood edge band
- Seating capacity based on 27" per person
- Overall table height 29.5"
- Four Post Base includes a 12"x24" center column for wire management. Center column may be removed from tables 96" and shorter with options -4COLP or -4COLV above. On tables over 96", the center column is required for support.
- T-Base combination finish includes a Polished Chrome foot and Powder Coat vertical column
- Beam finish will match Metal Finish selection. If no Metal Finish is selected, beams will be Foil.
- If Polished Chrome Finish is specified on the T-Base or Hoop Base, the beams will be Foil. If Polished Chrome Finish is specified on the Four Post Base, the beams will be Clear Anodized.
- Tables with three Hoop or T-Bases will default to the same base style for all three bases. An alternate Center Column Base may also be specified above.
- One wire manager included with the Hoop Base table (regardless of table size). Can be adhered to the leg and will default to the finish of the leg. If additional wire management channels are required, they can be purchased separately at the end of the pricelist.
- Center Wire Chase available on two base tables for more robust wire management needs. See page 128.
- Veneer base will default to flat-cut (non-plank) clear coat walnut and remain in vertical slip-match lay-up. Clear coat finish captures color variation to complement the variation of the plank door style.
- Panel, Rectangle, Expandable Rectangle, Island, Metal T-base, and Center Column bases have a removable access panel

### REQUIRED INFORMATION (ORDER CANNOT BE ENTERED WITHOUT THIS INFORMATION)

See appendix pages vi-vii for surface material options.

- Choose Metal Finish. Clear Anodized (-CA) not available on T-Base or Hoop Base.
- Choose Paint Finish, if -PP, -P4, -PR, -PX, -PN or -CRP bases are selected



# PLANK VENEER TOP WITH HARDWOOD EDGE



RADIUS RECTANGLE TOP

### BASE KEY

PP	Painted Panel	TB	Metal T-Base	VP	Veneer Panel
PR	Painted Rectangle	HP	Metal Hoop	VR	Veneer Rectangle
PX	Painted Expandable Rectangle			VX	Veneer Expanded Rectangle
PN	Island			VN	Island

### RADIUS RECTANGLE TABLES

MODEL #	L x W	BASE QTY	TOP SECTIONS	SEATING CAPACITY	-PP	-PR	-PX	-PN	-TB	-HP	-VP	-VR	-VX	-VN
FWNC-7236-PW	72 x 36	2	1	6	-	6,493	6,930	-	5,818	-	-	6,930	7,394	-
FWNC-7242-PW	72 x 42	2	1	6	-	7,377	7,853	-	6,642	-	-	7,853	8,356	-
FWNC-7842-PW	78 x 42	2	1	6	-	8,123	8,631	-	7,336	-	-	8,631	9,171	-
FWNC-8442-PW	84 x 42	2	1	8	-	8,355	8,864	-	7,570	-	-	8,864	9,403	-
FWNC-8448-PW	84 x 48	2	1	8	7,656	9,051	9,578	-	8,238	9,578	8,230	9,578	10,135	-
FWNC-9042-PW	90 x 42	2	1	8	-	9,035	9,570	-	8,208	-	-	9,570	10,137	-
FWNC-9048-PW	90 x 48	2	1	8	8,339	9,805	10,360	-	8,951	10,360	8,943	10,360	10,946	-
FWNC-9642-PW	96 x 42	2	1	8	-	9,280	9,815	-	8,453	-	-	9,815	10,382	-
FWNC-9648-PW	96 x 48	2	1	8	8,623	10,091	10,644	-	9,235	10,644	9,227	10,644	11,230	-
FWNC-10242-PW	102 x 42	2	1	8	-	10,055	10,620	-	9,182	-	-	10,620	11,219	-
FWNC-10248-PW	102 x 48	2	1	8	9,402	10,951	11,535	-	10,048	11,535	10,039	11,535	12,155	-
FWNC-10842-PW	108 x 42	2	1	10	-	10,314	10,878	-	9,441	-	-	10,878	11,477	-
FWNC-10848-PW	108 x 48	2	1	10	9,702	11,251	11,835	-	10,348	11,835	10,340	11,835	12,455	-
FWNC-10854-PW	108 x 54	2	1	12	10,743	12,360	12,970	13,852	11,417	12,970	11,407	12,970	13,616	14,486
FWNC-11442-PW	114 x 42	2	1	10	-	11,129	11,722	-	10,210	-	-	11,722	12,353	-
FWNC-11448-PW	114 x 48	2	1	10	10,530	12,159	12,775	-	11,210	12,775	11,200	12,775	13,427	-
FWNC-11454-PW	114 x 54	2	1	12	11,673	13,376	14,018	14,947	12,384	14,018	12,373	14,018	14,699	15,614
FWNC-12042-PW	120 x 42	2	1	10	-	11,402	11,996	-	10,484	-	-	11,996	12,626	-
FWNC-12048-PW	120 x 48	2	1	10	10,846	12,476	13,091	-	11,526	13,091	11,517	13,091	13,743	-
FWNC-12054-PW	120 x 54	2	1	12	12,039	13,741	14,384	15,313	12,748	14,384	12,739	14,384	15,064	15,979
FWNC-13248-PW	132 x 48	2	2	10	11,956	13,653	14,294	-	12,664	14,294	12,654	14,294	14,973	-
FWNC-13254-PW	132 x 54	2	2	12	13,301	15,075	15,744	16,711	14,041	15,744	14,030	15,744	16,454	17,406
FWNC-14448-PW	144 x 48	2	2	12	13,119	14,885	15,551	-	13,856	15,551	13,845	15,551	16,257	-
FWNC-14454-PW	144 x 54	2	2	14	14,626	16,471	17,165	18,173	15,396	17,165	15,385	17,165	17,904	18,895
FWNC-14460-PW	144 x 60	2	2	14	16,378	18,320	19,053	20,113	17,187	19,053	17,177	19,053	19,830	20,873
FWNC-15648-PW	156 x 48	3	2	14	16,580	19,256	20,266	-	17,697	20,266	17,681	20,266	21,336	-
FWNC-15654-PW	156 x 54	3	2	14	18,329	21,124	22,178	20,395	19,495	22,178	19,479	22,178	23,296	21,124
FWNC-15660-PW	156 x 60	3	2	14	20,369	23,312	24,423	22,544	21,596	24,423	21,580	24,423	25,601	23,312
FWNC-16854-PW	168 x 54	3	2	16	19,230	22,024	23,079	21,295	20,395	23,079	20,380	23,079	24,196	22,024
FWNC-16860-PW	168 x 60	3	2	16	21,400	24,343	25,453	23,574	22,627	25,453	22,611	25,453	26,631	24,343
FWNC-18054-PW	180 x 54	3	2	16	20,129	22,925	23,978	28,813	21,295	23,978	21,279	23,978	25,097	30,272
FWNC-18060-PW	180 x 60	3	2	16	22,430	25,373	26,484	31,575	23,657	26,484	23,641	26,484	27,661	33,111
FWNC-19254-PW	192 x 54	3	2	18	21,029	23,825	24,878	29,713	22,195	24,878	22,179	24,878	25,996	31,171
FWNC-19260-PW	192 x 60	3	2	18	23,460	26,403	27,514	32,605	24,688	27,514	24,671	27,514	28,692	34,142
FWNC-19266-PW	192 x 66	3	4	18	29,771	32,892	34,069	39,470	-	34,069	31,055	34,069	35,318	41,099
FWNC-19272-PW	192 x 72	3	4	18	31,430	34,551	35,729	41,129	-	35,729	32,715	35,729	36,978	42,759
FWNC-20454-PW	204 x 54	3	2	18	22,820	25,728	26,825	31,855	24,033	26,825	24,017	26,825	27,989	33,373
FWNC-20460-PW	204 x 60	3	2	18	25,483	28,547	29,703	35,001	26,762	29,703	26,744	29,703	30,927	36,599
FWNC-20466-PW	204 x 66	3	4	18	32,398	35,647	36,873	42,492	-	36,873	33,735	36,873	38,172	44,187
FWNC-20472-PW	204 x 72	3	4	18	34,234	37,482	38,708	44,327	-	38,708	35,570	38,708	40,008	46,022
FWNC-21654-PW	216 x 54	3	2	20	24,337	27,316	28,440	33,593	25,580	28,440	25,563	28,440	29,631	35,148
FWNC-21660-PW	216 x 60	3	2	20	27,204	30,342	31,525	36,952	28,512	31,525	28,495	31,525	32,781	38,590
FWNC-21666-PW	216 x 66	3	4	20	34,643	37,971	39,226	44,983	-	39,226	36,013	39,226	40,558	46,719
FWNC-21672-PW	216 x 72	3	4	20	36,635	39,963	41,218	46,975	-	41,218	38,005	41,218	42,549	48,711
FWNC-22854-PW	228 x 54	3	2	20	25,536	28,545	29,679	34,881	26,792	29,679	26,775	29,679	30,883	36,451
FWNC-22860-PW	228 x 60	3	2	20	28,572	31,739	32,934	38,414	29,894	32,934	29,875	32,934	34,201	40,066
FWNC-22866-PW	228 x 66	3	4	20	36,442	39,801	41,068	46,879	-	41,068	37,824	41,068	42,412	48,633
FWNC-22872-PW	228 x 72	3	4	20	38,563	41,923	43,190	49,001	-	43,190	39,946	43,190	44,534	50,755
FWNC-24054-PW	240 x 54	3	2	20	26,807	29,849	30,995	36,257	28,075	30,995	28,058	30,995	32,212	37,845
FWNC-24060-PW	240 x 60	3	2	20	30,017	33,219	34,428	39,969	31,353	34,428	31,335	34,428	35,709	41,641
FWNC-24066-PW	240 x 66	3	4	20	38,339	41,737	43,019	48,895	-	43,019	39,738	43,019	44,378	50,669
FWNC-24072-PW	240 x 72	3	4	20	40,598	43,996	45,277	51,154	-	45,277	41,996	45,277	46,636	52,928



# PLANK VENEER TOP WITH HARDWOOD EDGE

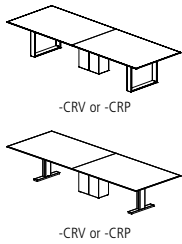

OPTIONS	CODE	PRICE	NOTES
Power and Data Options			See pages 119-129
<b>Remove Center Column for Four Post Base Options:</b>			
If -P4 base is selected	<b>-4COLP</b>	Deduct \$834	Tables 96" and shorter only
If -V4 base is selected	<b>-4COLV</b>	Deduct \$1,286	Tables 96" and shorter only
<b>Center Column Base Finish Options:</b>			
Painted Center Column Base*	Add <b>-CRP</b>	No Charge	To replace existing middle base (Hoop Base and T-Base only)
Veneer Center Column Base*	Add <b>-CRV</b>	No Charge	To replace existing middle base (Hoop Base and T-Base only)
<b>Polished Chrome Finish Options:</b>			
Polished Chrome Hoop Base (on 2 base tables)	Add <b>-PCHP2</b>	\$2,558	*When specifying -CRV or -CRP in conjunction with a Polished Chrome finish on Hoop Base or T-Base tables with 3 bases, use the upcharge code and pricing for 2 base tables (-PCHP2 or -PCTB2).
Polished Chrome Hoop Base (on 3 base tables)	Add <b>-PCHP3</b>	\$3,835	
Polished Chrome T-Base (on 2 base tables)	Add <b>-PCTB2</b>	\$2,558	
Polished Chrome T-Base (on 3 base tables)	Add <b>-PCTB3</b>	\$3,835	
T-Base Combination Finish (on 2 base tables)	Add <b>-PCCBF2</b>	\$1,566	
T-Base Combination Finish (on 3 base tables)	Add <b>-PCCBF3</b>	\$2,349	
<b>Multi-Section Tops:</b>			
102", 108", 114" and 120" one-piece tops split into two sections	Specify -2	\$761	Note: Power Matrix (center of table location only) cannot be specified when this option is selected
204", 216", 228" or 240" two-piece tops split into four sections	Specify -4	\$1,517	

## EDGE PROFILE

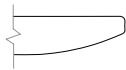

Reverse Flow Edge

## GENERAL INFORMATION

- Tops are 1-1/8"-thick with 3/16"-deep hardwood edge band
- Seating capacity based on 27" per person
- Overall table height 29.5"
- T-Base combination finish includes a Polished Chrome foot and Powder Coat vertical column
- Beam finish will match Metal Finish selection. If no Metal Finish is selected, beams will be Foil.
- If Polished Chrome Finish is specified on the T-Base or Hoop Base, the beams will be Foil. If Polished Chrome Finish is specified on the Four Post Base, the beams will be Clear Anodized.
- Tables with three Hoop or T-Bases will default to the same base style for all three bases. An alternate Center Column Base may also be specified above.
- One wire manager included with the Hoop Base table (regardless of table size). Can be adhered to the leg and will default to the finish of the leg. If additional wire management channels are required, they can be purchased separately at the end of the pricelist.
- Center Wire Chase available on two base tables for more robust wire management needs. See page 128.
- Veneer base will default to flat-cut (non-plank) clear coat walnut and remain in vertical slip-match lay-up. Clear coat finish captures color variation to complement the variation of the plank door style.
- Panel, Rectangle, Expandable Rectangle, Island, Metal T-base, and Center Column bases have a removable access panel

### REQUIRED INFORMATION (ORDER CANNOT BE ENTERED WITHOUT THIS INFORMATION)

See appendix pages vi-vii for surface material options.

- Choose Metal Finish. Clear Anodized (-CA) not available on T-Base or Hoop Base.
- Choose Paint Finish, if -PP, -PR, -PX, -PN or -CRP bases are selected



# PLANK VENEER TOP WITH HARDWOOD EDGE

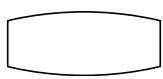

BOAT TOP

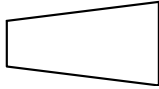

SIGHT LINE TOP

### BASE KEY

PP	Painted Panel	TB	Metal T-Base	VP	Veneer Panel
P4	Painted Four Post	HP	Metal Hoop	V4	Veneer Four Post
PR	Painted Rectangle			VR	Veneer Rectangle
PX	Painted Expandable Rectangle			VX	Veneer Expanded Rectangle

### BOAT TABLES

MODEL #	L x W	BASE QTY	TOP SECTIONS	SEATING CAPACITY	-PP	-P4	-PR	-PX	-TB	-HP	-VP	-V4	-VR	-VX
FWNB-7240-PW	72 x 32/40	2	1	6	6,010	7,271	7,271	7,747	6,536	-	6,529	7,747	7,747	8,251
FWNB-7840-PW	78 x 32/40	2	1	6	6,652	8,001	8,001	8,509	7,214	-	7,208	8,509	8,509	9,049
FWNB-8444-PW	84 x 32/44	2	1	8	7,385	8,780	8,780	9,306	7,967	-	7,958	9,306	9,306	9,864
FWNB-9044-PW	90 x 32/44	2	1	8	8,033	9,499	9,499	10,054	8,645	-	8,637	10,054	10,054	10,640
FWNB-9648-PW	96 x 36/48	2	1	8	8,623	10,091	10,091	10,644	9,235	10,644	9,227	10,644	10,644	11,230
FWNB-10248-PW	102 x 36/48	2	1	8	9,402	10,951	10,951	11,535	10,048	11,535	10,039	11,535	11,535	12,155
FWNB-10848-PW	108 x 36/48	2	1	10	9,702	11,251	11,251	11,835	10,348	11,835	10,340	11,835	11,835	12,455
FWNB-11450-PW	114 x 36/50	2	1	10	11,222	12,925	12,925	13,567	11,933	13,567	11,923	13,567	13,567	14,248
FWNB-12050-PW	120 x 36/50	2	1	10	11,565	13,267	13,267	13,910	12,274	13,910	12,265	13,910	13,910	14,591
FWNB-13254-PW	132 x 36/54	2	2	10	13,301	15,075	15,075	15,744	14,041	15,744	14,030	15,744	15,744	16,454
FWNB-14454-PW	144 x 36/54	2	2	12	14,626	16,471	16,471	17,165	15,396	17,165	15,385	17,165	17,165	17,904
FWNB-15654-PW	156 x 36/54	3	2	12	18,329	21,124	21,124	22,178	19,495	22,178	19,479	22,178	22,178	23,296
FWNB-16860-PW	168 x 42/60	3	2	14	21,400	24,343	24,343	25,453	22,627	25,453	22,611	25,453	25,453	26,631
FWNB-18060-PW	180 x 42/60	3	2	14	22,430	25,373	25,373	26,484	23,657	26,484	23,641	26,484	26,484	27,661
FWNB-19272-PW	192 x 54/72	3	4	18	31,430	34,551	34,551	35,729	-	35,729	32,715	35,729	35,729	36,978
FWNB-20472-PW	204 x 54/72	3	4	18	34,234	37,482	37,482	38,708	-	38,708	35,570	38,708	38,708	40,008
FWNB-21672-PW	216 x 54/72	3	4	20	36,635	39,963	39,963	41,218	-	41,218	38,005	41,218	41,218	42,549
FWNB-22872-PW	228 x 54/72	3	4	20	38,563	41,923	41,923	43,190	-	43,190	39,946	43,190	43,190	44,534
FWNB-24072-PW	240 x 54/72	3	4	20	40,598	43,996	43,996	45,277	-	45,277	41,996	45,277	45,277	46,636

### SIGHT LINE TABLES

MODEL #	L x W	BASE QTY	TOP SECTIONS	SEATING CAPACITY	-PP	-P4	-PR	-PX	-TB	-HP	-VP	-V4	-VR	-VX
FWNA-7254-PW	72 x 36/54	2	1	7	7,291	-	8,653	9,167	7,860	9,167	7,852	-	9,167	9,712
FWNA-7856-PW	78 x 36/56	2	1	7	8,681	-	10,215	10,793	9,320	10,793	9,311	-	10,793	11,406
FWNA-8458-PW	84 x 36/58	2	1	9	9,169	-	10,704	11,282	9,810	11,282	9,801	-	11,282	11,896
FWNA-9060-PW	90 x 36/60	2	1	9	10,184	-	11,798	12,407	10,858	12,407	10,848	-	12,407	13,052
FWNA-9660-PW	96 x 36/60	2	1	9	10,564	-	12,178	12,787	11,237	12,787	11,228	-	12,787	13,432
FWNA-10260-PW	102 x 36/60	2	1	9	11,551	-	13,255	13,897	12,262	13,897	12,253	-	13,897	14,579
FWNA-10860-PW	108 x 36/60	2	1	11	11,954	-	13,657	14,300	12,664	14,300	12,655	-	14,300	14,982
FWNA-11460-PW	114 x 36/60	2	1	11	13,006	-	14,799	15,475	13,753	15,475	13,743	-	15,475	16,192
FWNA-12066-PW	120 x 36/66	2	2	11	17,217	-	19,119	19,836	18,011	19,836	17,999	-	19,836	20,597
FWNA-13268-PW	132 x 36/68	2	3	11	19,488	-	21,470	22,217	20,315	22,217	20,304	-	22,217	23,010
FWNA-14470-PW	144 x 36/70	2	3	13	21,954	-	24,014	24,791	-	24,791	22,802	-	24,791	25,616
FWNA-15672-PW	156 x 36/72	3	3	13	27,024	-	30,147	31,324	-	31,324	28,309	-	31,324	32,573
FWNA-16876-PW	168 x 36/76	3	3	15	28,621	-	31,653	32,797	-	32,797	29,868	-	32,797	34,011
FWNA-18078-PW	180 x 36/78	3	3	15	30,618	-	33,651	34,795	-	34,795	31,866	-	34,795	36,007
FWNA-19278-PW	192 x 36/78	3	4	17	32,145	-	35,178	36,322	-	36,322	33,393	-	36,322	37,535
FWNA-20478-PW	204 x 36/78	3	4	17	35,039	-	38,195	39,386	-	39,386	36,337	-	39,386	40,648
FWNA-21678-PW	216 x 36/78	3	4	19	37,523	-	40,755	41,974	-	41,974	38,852	-	41,974	43,268
FWNA-22878-PW	228 x 36/78	3	4	19	39,523	-	42,786	44,018	-	44,018	40,866	-	44,018	45,323
FWNA-24078-PW	240 x 36/78	3	4	19	41,632	-	44,932	46,178	-	46,178	42,990	-	46,178	47,498



# PLANK VENEER TOP WITH HARDWOOD EDGE

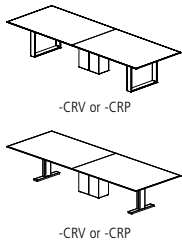

OPTIONS	CODE	PRICE	NOTES
Power and Data Options			See pages 119-129
<b>Remove Center Column for Four Post Base Options:</b>			
If -P4 base is selected	-4COLP	Deduct \$834	Tables 96" and shorter only
If -V4 base is selected	-4COLV	Deduct \$1,286	Tables 96" and shorter only
<b>Center Column Base Finish Options:</b>			
Painted Center Column Base*	Add -CRP	No Charge	To replace existing middle base (Hoop Base and T-Base only)
Veneer Center Column Base*	Add -CRV	No Charge	To replace existing middle base (Hoop Base and T-Base only)
<b>Polished Chrome Finish Options:</b>			
Polished Chrome Hoop Base (on 2 base tables)	Add -PCHP2	\$2,558	*When specifying -CRV or -CRP in conjunction with a Polished Chrome finish on Hoop Base or T-Base tables with 3 bases, use the upcharge code and pricing for 2 base tables (-PCHP2 or -PCTB2).
Polished Chrome Hoop Base (on 3 base tables)	Add -PCHP3	\$3,835	
Polished Chrome T-Base (on 2 base tables)	Add -PCTB2	\$2,558	
Polished Chrome T-Base (on 3 base tables)	Add -PCTB3	\$3,835	
T-Base Combination Finish (on 2 base tables)	Add -PCCBF2	\$1,566	
T-Base Combination Finish (on 3 base tables)	Add -PCCBF3	\$2,349	
<b>Multi-Section Tops:</b>			
102", 108", 114" and 120" one-piece tops split into two sections	Specify -2	\$761	Note: Power Matrix (center of table location only) cannot be specified when this option is selected

## EDGE PROFILE

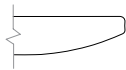

Reverse Flow Edge

## GENERAL INFORMATION

- Tops are 1-1/8" thick with 3/16" deep hardwood edge band
- Seating capacity based on 27" per person
- Overall table height 29.5"
- Four Post Base includes a 12"x24" center column for wire management. Center column may be removed from tables 96" and shorter with options -4COLP or -4COLV above. On tables over 96", the center column is required for support.
- T-Base combination finish includes a Polished Chrome foot and Powder Coat vertical column
- Beam finish will match Metal Finish selection. If no Metal Finish is selected, beams will be Foil.
- If Polished Chrome Finish is specified on the T-Base or Hoop Base, the beams will be Foil. If Polished Chrome Finish is specified on the Four Post Base, the beams will be Clear Anodized.
- Tables with three Hoop or T-Bases will default to the same base style for all three bases. An alternate Center Column Base may also be specified above.
- One wire manager included with the Hoop Base table (regardless of table size). Can be adhered to the leg and will default to the finish of the leg. If additional wire management channels are required, they can be purchased separately at the end of the pricelist.
- Center Wire Chase available on two base tables for more robust wire management needs. See page 128.
- Veneer base will default to flat-cut (non-plank) clear coat walnut and remain in vertical slip-match lay-up. Clear coat finish captures color variation to complement the variation of the plank door style.
- Panel, Rectangle, Expandable Rectangle, Metal T-base, and Center Column bases have a removable access panel

### REQUIRED INFORMATION (ORDER CANNOT BE ENTERED WITHOUT THIS INFORMATION)

See appendix pages vi-vii for surface material options.

- Choose Metal Finish. Clear Anodized (-CA) not available on T-Base or Hoop Base.
- Choose Paint Finish, if -PP, -P4, -PR, -PX or -CRP bases are selected





# INSET LAMINATE TOP WITH HARDWOOD EDGE

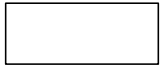

RECTANGLE TOP

**BASE KEY**

PP	Painted Panel	TB	Metal T-Base	VP	Veneer Panel
P4	Painted Four Post	HP	Metal Hoop	V4	Veneer Four Post
PR	Painted Rectangle			VR	Veneer Rectangle
PX	Painted Expandable Rectangle			VX	Veneer Expanded Rectangle
PN	Island			VN	Island

**RECTANGLE TABLES**

MODEL #	L x W	BASE QTY	TOP SECTIONS	SEATING CAPACITY	-PP	-P4	-PR	-PX	-PN	-TB	-HP	-VP	-V4	-VR	-VX	-VN
FWNT-7236-V-P	72 x 36	2	1	6	-	5,336	5,336	5,695	-	4,781	-	-	5,695	5,695	6,076	-
FWNT-7242-V-P	72 x 42	2	1	6	-	6,062	6,062	6,453	-	5,458	-	-	6,453	6,453	6,867	-
FWNT-7842-V-P	78 x 42	2	1	6	-	6,675	6,675	7,093	-	6,029	-	-	7,093	7,093	7,536	-
FWNT-8442-V-P	84 x 42	2	1	8	-	6,866	6,866	7,284	-	6,220	-	-	7,284	7,284	7,727	-
FWNT-8448-V-P	84 x 48	2	1	8	6,291	7,438	7,438	7,870	-	6,770	7,870	6,763	7,870	7,870	8,329	-
FWNT-9042-V-P	90 x 42	2	1	8	-	7,424	7,424	7,864	-	6,745	-	-	7,864	7,864	8,330	-
FWNT-9048-V-P	90 x 48	2	1	8	6,853	8,058	8,058	8,513	-	7,355	8,513	7,349	8,513	8,513	8,995	-
FWNT-9642-V-P	96 x 42	2	1	8	-	7,626	7,626	8,065	-	6,946	-	-	8,065	8,065	8,531	-
FWNT-9648-V-P	96 x 48	2	1	8	7,086	8,292	8,292	8,746	-	7,589	8,746	7,582	8,746	8,746	9,228	-
FWNT-10242-V-P	102 x 42	2	1	8	-	8,263	8,263	8,727	-	7,545	-	-	8,727	8,727	9,219	-
FWNT-10248-V-P	102 x 48	2	1	8	7,726	8,999	8,999	9,479	-	8,257	9,479	8,249	9,479	9,479	9,988	-
FWNT-10842-V-P	108 x 42	2	1	10	-	8,475	8,475	8,939	-	7,758	-	-	8,939	8,939	9,432	-
FWNT-10848-V-P	108 x 48	2	1	10	7,973	9,245	9,245	9,725	-	8,504	9,725	8,497	9,725	9,725	10,235	-
FWNT-10854-V-P	108 x 54	2	1	12	8,828	10,156	10,156	10,658	11,383	9,382	10,658	9,374	10,658	10,658	11,189	11,904
FWNT-11442-V-P	114 x 42	2	1	10	-	9,145	9,145	9,633	-	8,390	-	-	9,633	9,633	10,151	-
FWNT-11448-V-P	114 x 48	2	1	10	8,653	9,992	9,992	10,498	-	9,211	10,498	9,204	10,498	10,498	11,033	-
FWNT-11454-V-P	114 x 54	2	1	12	9,592	10,992	10,992	11,519	12,283	10,176	11,519	10,168	11,519	11,519	12,079	12,831
FWNT-12042-V-P	120 x 42	2	1	10	-	9,369	9,369	9,858	-	8,615	-	-	9,858	9,858	10,376	-
FWNT-12048-V-P	120 x 48	2	1	10	8,913	10,252	10,252	10,757	-	9,471	10,757	9,464	10,757	10,757	11,293	-
FWNT-12054-V-P	120 x 54	2	1	12	9,893	11,291	11,291	11,820	12,583	10,476	11,820	10,468	11,820	11,820	12,379	13,130
FWNT-13248-V-P	132 x 48	2	2	10	9,825	11,220	11,220	11,746	-	10,407	11,746	10,398	11,746	11,746	12,304	-
FWNT-13254-V-P	132 x 54	2	2	12	10,930	12,388	12,388	12,938	13,732	11,538	12,938	11,529	12,938	12,938	13,521	14,303
FWNT-14448-V-P	144 x 48	2	2	12	10,780	12,232	12,232	12,779	-	11,386	12,779	11,377	12,779	12,779	13,359	-
FWNT-14454-V-P	144 x 54	2	2	14	12,019	13,535	13,535	14,106	14,933	12,651	14,106	12,643	14,106	14,106	14,712	15,527
FWNT-14460-V-P	144 x 60	2	2	14	13,458	15,054	15,054	15,656	16,528	14,124	15,656	14,115	15,656	15,656	16,295	17,152
FWNT-15648-V-P	156 x 48	3	2	14	13,625	-	15,824	16,653	-	14,542	16,653	14,529	-	16,653	17,533	-
FWNT-15654-V-P	156 x 54	3	2	14	15,062	17,358	17,358	18,225	16,759	16,020	18,225	16,007	18,225	18,225	19,143	17,358
FWNT-15660-V-P	156 x 60	3	2	14	16,738	19,157	19,157	20,069	18,525	17,747	20,069	17,733	20,069	20,069	21,037	19,157
FWNT-16854-V-P	168 x 54	3	2	16	15,802	18,098	18,098	18,965	17,499	16,759	18,965	16,747	18,965	18,965	19,883	18,098
FWNT-16860-V-P	168 x 60	3	2	16	17,585	20,003	20,003	20,916	19,372	18,593	20,916	18,580	20,916	20,916	21,884	20,003
FWNT-18054-V-P	180 x 54	3	2	16	16,541	18,838	18,838	19,704	23,677	17,499	19,704	17,486	19,704	19,704	20,623	24,876
FWNT-18060-V-P	180 x 60	3	2	16	18,432	20,850	20,850	21,763	25,946	19,440	21,763	19,427	21,763	21,763	22,731	27,209
FWNT-19254-V-P	192 x 54	3	2	18	17,281	19,578	19,578	20,444	24,416	18,239	20,444	18,226	20,444	20,444	21,362	25,615
FWNT-19260-V-P	192 x 60	3	2	18	19,278	21,697	21,697	22,610	26,793	20,287	22,610	20,274	22,610	22,610	23,577	28,056
FWNT-19266-V-P	192 x 66	3	4	18	24,464	27,028	27,028	27,996	32,434	-	27,996	25,519	27,996	27,996	29,022	33,773
FWNT-19272-V-P	192 x 72	3	4	18	25,827	28,392	28,392	29,360	33,797	-	29,360	26,883	29,360	29,360	30,386	35,137
FWNT-20454-V-P	204 x 54	3	2	18	18,752	21,142	21,142	22,044	26,177	19,749	22,044	19,736	22,044	22,044	23,000	27,424
FWNT-20460-V-P	204 x 60	3	2	18	20,941	23,458	23,458	24,408	28,762	21,992	24,408	21,976	24,408	24,408	25,414	30,075
FWNT-20466-V-P	204 x 66	3	4	18	26,623	29,293	29,293	30,300	34,917	-	30,300	27,721	30,300	30,300	31,368	36,310
FWNT-20472-V-P	204 x 72	3	4	18	28,131	30,801	30,801	31,808	36,426	-	31,808	29,229	31,808	31,808	32,876	37,818
FWNT-21654-V-P	216 x 54	3	2	20	19,999	22,447	22,447	23,370	27,605	21,020	23,370	21,006	23,370	23,370	24,349	28,883
FWNT-21660-V-P	216 x 60	3	2	20	22,354	24,933	24,933	25,906	30,365	23,430	25,906	23,416	25,906	25,906	26,938	31,711
FWNT-21666-V-P	216 x 66	3	4	20	28,468	31,203	31,203	32,234	36,964	-	32,234	29,593	32,234	32,234	33,328	38,391
FWNT-21672-V-P	216 x 72	3	4	20	30,104	32,839	32,839	33,870	38,601	-	33,870	31,230	33,870	33,870	34,965	40,028
FWNT-22854-V-P	228 x 54	3	2	20	20,984	23,456	23,456	24,388	28,663	22,016	24,388	22,002	24,388	24,388	25,378	29,953
FWNT-22860-V-P	228 x 60	3	2	20	23,479	26,082	26,082	27,063	31,566	24,565	27,063	24,550	27,063	27,063	28,105	32,924
FWNT-22866-V-P	228 x 66	3	4	20	29,946	32,706	32,706	33,747	38,522	-	33,747	31,082	33,747	33,747	34,852	39,964
FWNT-22872-V-P	228 x 72	3	4	20	31,689	34,450	34,450	35,491	40,266	-	35,491	32,825	35,491	35,491	36,596	41,707
FWNT-24054-V-P	240 x 54	3	2	20	22,028	24,528	24,528	25,470	29,794	23,071	25,470	23,057	25,470	25,470	26,470	31,099
FWNT-24060-V-P	240 x 60	3	2	20	24,666	27,298	27,298	28,291	32,844	25,764	28,291	25,749	28,291	28,291	29,344	34,218
FWNT-24066-V-P	240 x 66	3	4	20	31,505	34,297	34,297	35,350	40,179	-	35,350	32,654	35,350	35,350	36,467	41,637
FWNT-24072-V-P	240 x 72	3	4	20	33,361	36,153	36,153	37,206	42,035	-	37,206	34,510	37,206	37,206	38,323	43,493



# INSET LAMINATE TOP WITH HARDWOOD EDGE

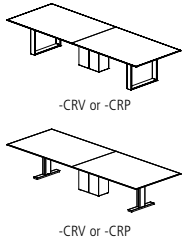

OPTIONS	CODE	PRICE	NOTES
Power and Data Options			See pages 119-129
<b>Remove Center Column for Four Post Base Options:</b>			
If -P4 base is selected	<b>-4COLP</b>	Deduct \$834	Tables 96" and shorter only
If -V4 base is selected	<b>-4COLV</b>	Deduct \$1,286	Tables 96" and shorter only
<b>Center Column Base Finish Options:</b>			
Painted Center Column Base*	Add <b>-CRP</b>	No Charge	To replace existing middle base (Hoop Base and T-Base only)
Veneer Center Column Base*	Add <b>-CRV</b>	No Charge	To replace existing middle base (Hoop Base and T-Base only)
<b>Polished Chrome Finish Options:</b>			
Polished Chrome Four Post Base	Add <b>-PCFB</b>	\$2,558	*When specifying -CRV or -CRP in conjunction with a Polished Chrome finish on Hoop Base or T-Base tables with 3 bases, use the upcharge code and pricing for 2 base tables (-PCHP2 or -PCTB2).
Polished Chrome Hoop Base (on 2 base tables)	Add <b>-PCHP2</b>	\$2,558	
Polished Chrome Hoop Base (on 3 base tables)	Add <b>-PCHP3</b>	\$3,835	
Polished Chrome T-Base (on 2 base tables)	Add <b>-PCTB2</b>	\$2,558	
Polished Chrome T-Base (on 3 base tables)	Add <b>-PCTB3</b>	\$3,835	
T-Base Combination Finish (on 2 base tables)	Add <b>-PCCBF2</b>	\$1,566	
T-Base Combination Finish (on 3 base tables)	Add <b>-PCCBF3</b>	\$2,349	
<b>Multi-Section Tops:</b>			
102", 108", 114" and 120" one-piece tops split into two sections	Specify -2	\$761	Note: Power Matrix (center of table location only) cannot be specified when this option is selected
204", 216", 228" or 240" two-piece tops split into four sections	Specify -4	\$1,517	

## EDGE PROFILE

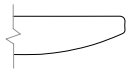

Reverse Flow Edge

## GENERAL INFORMATION

- Tops are 1-1/8"-thick with 3/16"-deep hardwood edge band
- Seating capacity based on 27" per person
- Overall table height 29.5"
- Four Post Base includes a 12"x24" center column for wire management. Center column may be removed from tables 96" and shorter with options -4COLP or -4COLV above. On tables over 96", the center column is required for support.
- T-Base combination finish includes a Polished Chrome foot and Powder Coat vertical column
- Beam finish will match Metal Finish selection. If no Metal Finish is selected, beams will be Foil.
- If Polished Chrome Finish is specified on the T-Base or Hoop Base, the beams will be Foil. If Polished Chrome Finish is specified on the Four Post Base, the beams will be Clear Anodized.
- Tables with three Hoop or T-Bases will default to the same base style for all three bases. An alternate Center Column Base may also be specified above.
- One wire manager included with the Hoop Base table (regardless of table size). Can be adhered to the leg and will default to the finish of the leg. If additional wire management channels are required, they can be purchased separately at the end of the pricelist.
- Center Wire Chase available on two base tables for more robust wire management needs. See page 128.
- Panel, Rectangle, Expandable Rectangle, Island, Metal T-base, and Center Column bases have a removable access panel

### REQUIRED INFORMATION (ORDER CANNOT BE ENTERED WITHOUT THIS INFORMATION)

See appendix pages vi-vii for surface material options.

- Choose Veneer Finish
- Choose Laminate
- Choose Metal Finish. Clear Anodized (-CA) not available on T-Base or Hoop Base.
- Choose Paint Finish, if -PP, -P4, -PR, -PX, -PN or -CRP bases are selected



# INSET LAMINATE TOP WITH HARDWOOD EDGE



RADIUS RECTANGLE TOP

**BASE KEY**

PP	Painted Panel	TB	Metal T-Base	VP	Veneer Panel
PR	Painted Rectangle	HP	Metal Hoop	VR	Veneer Rectangle
PX	Painted Expandable Rectangle			VX	Veneer Expanded Rectangle
PN	Island			VN	Island

**RADIUS RECTANGLE TABLES**

MODEL #	L x W	BASE QTY	TOP SECTIONS	SEATING CAPACITY	-PP	-PR	-PX	-PN	-TB	-HP	-VP	-VR	-VX	-VN
FWNC-7236-V-P	72 x 36	2	1	6	-	5,336	5,695	-	4,781	-	-	5,695	6,076	-
FWNC-7242-V-P	72 x 42	2	1	6	-	6,062	6,453	-	5,458	-	-	6,453	6,867	-
FWNC-7842-V-P	78 x 42	2	1	6	-	6,675	7,093	-	6,029	-	-	7,093	7,536	-
FWNC-8442-V-P	84 x 42	2	1	8	-	6,866	7,284	-	6,220	-	-	7,284	7,727	-
FWNC-8448-V-P	84 x 48	2	1	8	6,291	7,438	7,870	-	6,770	7,870	6,763	7,870	8,329	-
FWNC-9042-V-P	90 x 42	2	1	8	-	7,424	7,864	-	6,745	-	-	7,864	8,330	-
FWNC-9048-V-P	90 x 48	2	1	8	6,853	8,058	8,513	-	7,355	8,513	7,349	8,513	8,995	-
FWNC-9642-V-P	96 x 42	2	1	8	-	7,626	8,065	-	6,946	-	-	8,065	8,531	-
FWNC-9648-V-P	96 x 48	2	1	8	7,086	8,292	8,746	-	7,589	8,746	7,582	8,746	9,228	-
FWNC-10242-V-P	102 x 42	2	1	8	-	8,263	8,727	-	7,545	-	-	8,727	9,219	-
FWNC-10248-V-P	102 x 48	2	1	8	7,726	8,999	9,479	-	8,257	9,479	8,249	9,479	9,988	-
FWNC-10842-V-P	108 x 42	2	1	10	-	8,475	8,939	-	7,758	-	-	8,939	9,432	-
FWNC-10848-V-P	108 x 48	2	1	10	7,973	9,245	9,725	-	8,504	9,725	8,497	9,725	10,235	-
FWNC-10854-V-P	108 x 54	2	1	12	8,828	10,156	10,658	11,383	9,382	10,658	9,374	10,658	11,189	11,904
FWNC-11442-V-P	114 x 42	2	1	10	-	9,145	9,633	-	8,390	-	-	9,633	10,151	-
FWNC-11448-V-P	114 x 48	2	1	10	8,653	9,992	10,498	-	9,211	10,498	9,204	10,498	11,033	-
FWNC-11454-V-P	114 x 54	2	1	12	9,592	10,992	11,519	12,283	10,176	11,519	10,168	11,519	12,079	12,831
FWNC-12042-V-P	120 x 42	2	1	10	-	9,369	9,858	-	8,615	-	-	9,858	10,376	-
FWNC-12048-V-P	120 x 48	2	1	10	8,913	10,252	10,757	-	9,471	10,757	9,464	10,757	11,293	-
FWNC-12054-V-P	120 x 54	2	1	12	9,893	11,291	11,820	12,583	10,476	11,820	10,468	11,820	12,379	13,130
FWNC-13248-V-P	132 x 48	2	2	10	9,825	11,220	11,746	-	10,407	11,746	10,398	11,746	12,304	-
FWNC-13254-V-P	132 x 54	2	2	12	10,930	12,388	12,938	13,732	11,538	12,938	11,529	12,938	13,521	14,303
FWNC-14448-V-P	144 x 48	2	2	12	10,780	12,232	12,779	-	11,386	12,779	11,377	12,779	13,359	-
FWNC-14454-V-P	144 x 54	2	2	14	12,019	13,535	14,106	14,933	12,651	14,106	12,643	14,106	14,712	15,527
FWNC-14460-V-P	144 x 60	2	2	14	13,458	15,054	15,656	16,528	14,124	15,656	14,115	15,656	16,295	17,152
FWNC-15648-V-P	156 x 48	3	2	14	13,625	15,824	16,653	-	14,542	16,653	14,529	16,653	17,533	-
FWNC-15654-V-P	156 x 54	3	2	14	15,062	17,358	18,225	16,759	16,020	18,225	16,007	18,225	19,143	17,358
FWNC-15660-V-P	156 x 60	3	2	14	16,738	19,157	20,069	18,525	17,747	20,069	17,733	20,069	21,037	19,157
FWNC-16854-V-P	168 x 54	3	2	16	15,802	18,098	18,965	17,499	16,759	18,965	16,747	18,965	19,883	18,098
FWNC-16860-V-P	168 x 60	3	2	16	17,585	20,003	20,916	19,372	18,593	20,916	18,580	20,916	21,884	20,003
FWNC-18054-V-P	180 x 54	3	2	16	16,541	18,838	19,704	23,677	17,499	19,704	17,486	19,704	20,623	24,876
FWNC-18060-V-P	180 x 60	3	2	16	18,432	20,850	21,763	25,946	19,440	21,763	19,427	21,763	22,731	27,209
FWNC-19254-V-P	192 x 54	3	2	18	17,281	19,578	20,444	24,416	18,239	20,444	18,226	20,444	21,362	25,615
FWNC-19260-V-P	192 x 60	3	2	18	19,278	21,697	22,610	26,793	20,287	22,610	20,274	22,610	23,577	28,056
FWNC-19266-V-P	192 x 66	3	4	18	24,464	27,028	27,996	32,434	-	27,996	25,519	27,996	29,022	33,773
FWNC-19272-V-P	192 x 72	3	4	18	25,827	28,392	29,360	33,797	-	29,360	26,883	29,360	30,386	35,137
FWNC-20454-V-P	204 x 54	3	2	18	18,752	21,142	22,044	26,177	19,749	22,044	19,736	22,044	23,000	27,424
FWNC-20460-V-P	204 x 60	3	2	18	20,941	23,458	24,408	28,762	21,992	24,408	21,976	24,408	25,414	30,075
FWNC-20466-V-P	204 x 66	3	4	18	26,623	29,293	30,300	34,917	-	30,300	27,721	30,300	31,368	36,310
FWNC-20472-V-P	204 x 72	3	4	18	28,131	30,801	31,808	36,426	-	31,808	29,229	31,808	32,876	37,818
FWNC-21654-V-P	216 x 54	3	2	20	19,999	22,447	23,370	27,605	21,020	23,370	21,006	23,370	24,349	28,883
FWNC-21660-V-P	216 x 60	3	2	20	22,354	24,933	25,906	30,365	23,430	25,906	23,416	25,906	26,938	31,711
FWNC-21666-V-P	216 x 66	3	4	20	28,468	31,203	32,234	36,964	-	32,234	29,593	32,234	33,328	38,391
FWNC-21672-V-P	216 x 72	3	4	20	30,104	32,839	33,870	38,601	-	33,870	31,230	33,870	34,965	40,028
FWNC-22854-V-P	228 x 54	3	2	20	20,984	23,456	24,388	28,663	22,016	24,388	22,002	24,388	25,378	29,953
FWNC-22860-V-P	228 x 60	3	2	20	23,479	26,082	27,063	31,566	24,565	27,063	24,550	27,063	28,105	32,924
FWNC-22866-V-P	228 x 66	3	4	20	29,946	32,706	33,747	38,522	-	33,747	31,082	33,747	34,852	39,964
FWNC-22872-V-P	228 x 72	3	4	20	31,689	34,450	35,491	40,266	-	35,491	32,825	35,491	36,596	41,707
FWNC-24054-V-P	240 x 54	3	2	20	22,028	24,528	25,470	29,794	23,071	25,470	23,057	25,470	26,470	31,099
FWNC-24060-V-P	240 x 60	3	2	20	24,666	27,298	28,291	32,844	25,764	28,291	25,749	28,291	29,344	34,218
FWNC-24066-V-P	240 x 66	3	4	20	31,505	34,297	35,350	40,179	-	35,350	32,654	35,350	36,467	41,637
FWNC-24072-V-P	240 x 72	3	4	20	33,361	36,153	37,206	42,035	-	37,206	34,510	37,206	38,323	43,493



# INSET LAMINATE TOP WITH HARDWOOD EDGE

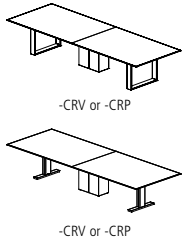

OPTIONS	CODE	PRICE	NOTES
Power and Data Options			See pages 119-129
<b>Remove Center Column for Four Post Base Options:</b>			
If -P4 base is selected	<b>-4COLP</b>	Deduct \$834	Tables 96" and shorter only
If -V4 base is selected	<b>-4COLV</b>	Deduct \$1,286	Tables 96" and shorter only
<b>Center Column Base Finish Options:</b>			
Painted Center Column Base*	Add <b>-CRP</b>	No Charge	To replace existing middle base (Hoop Base and T-Base only)
Veneer Center Column Base*	Add <b>-CRV</b>	No Charge	To replace existing middle base (Hoop Base and T-Base only)
<b>Polished Chrome Finish Options:</b>			
Polished Chrome Hoop Base (on 2 base tables)	Add <b>-PCHP2</b>	\$2,558	*When specifying -CRV or -CRP in conjunction with a Polished Chrome finish on Hoop Base or T-Base tables with 3 bases, use the upcharge code and pricing for 2 base tables (-PCHP2 or -PCTB2).
Polished Chrome Hoop Base (on 3 base tables)	Add <b>-PCHP3</b>	\$3,835	
Polished Chrome T-Base (on 2 base tables)	Add <b>-PCTB2</b>	\$2,558	
Polished Chrome T-Base (on 3 base tables)	Add <b>-PCTB3</b>	\$3,835	
T-Base Combination Finish (on 2 base tables)	Add <b>-PCCBF2</b>	\$1,566	
T-Base Combination Finish (on 3 base tables)	Add <b>-PCCBF3</b>	\$2,349	
<b>Multi-Section Tops:</b>			
102", 108", 114" and 120" one-piece tops split into two sections	Specify -2	\$761	Note: Power Matrix (center of table location only) cannot be specified when this option is selected
204", 216", 228" or 240" two-piece tops split into four sections	Specify -4	\$1,517	

## EDGE PROFILE

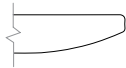

Reverse Flow Edge

## GENERAL INFORMATION

- Tops are 1-1/8"-thick with 3/16"-deep hardwood edge band
- Seating capacity based on 27" per person
- Overall table height 29.5"
- T-Base combination finish includes a Polished Chrome foot and Powder Coat vertical column
- Beam finish will match Metal Finish selection. If no Metal Finish is selected, beams will be Foil.
- If Polished Chrome Finish is specified on the T-Base or Hoop Base, the beams will be Foil. If Polished Chrome Finish is specified on the Four Post Base, the beams will be Clear Anodized.
- Tables with three Hoop or T-Bases will default to the same base style for all three bases. An alternate Center Column Base may also be specified above.
- One wire manager included with the Hoop Base table (regardless of table size). Can be adhered to the leg and will default to the finish of the leg. If additional wire management channels are required, they can be purchased separately at the end of the pricelist.
- Center Wire Chase available on two base tables for more robust wire management needs. See page 128.
- Panel, Rectangle, Expandable Rectangle, Island, Metal T-base, and Center Column bases have a removable access panel

### REQUIRED INFORMATION (ORDER CANNOT BE ENTERED WITHOUT THIS INFORMATION)

See appendix pages vi-vii for surface material options.

- Choose Veneer Finish
- Choose Laminate
- Choose Metal Finish. Clear Anodized (-CA) not available on T-Base or Hoop Base.
- Choose Paint Finish, if -PP, -PR, -PX, -PN or -CRP bases are selected



# INSET LAMINATE TOP WITH HARDWOOD EDGE

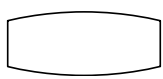

BOAT TOP

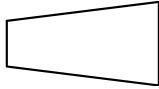

SIGHT LINE TOP

**BASE KEY**

PP	Painted Panel	TB	Metal T-Base	VP	Veneer Panel
P4	Painted Four Post	HP	Metal Hoop	V4	Veneer Four Post
PR	Painted Rectangle			VR	Veneer Rectangle
PX	Painted Expandable Rectangle			VX	Veneer Expanded Rectangle

**BOAT TABLES**

MODEL #	L x W	BASE QTY	TOP SECTIONS	SEATING CAPACITY	-PP	-P4	-PR	-PX	-TB	-HP	-VP	-V4	-VR	-VX
FWNB-7240-V-P	72 x 32/40	2	1	6	4,939	5,975	5,975	6,366	5,371	-	5,365	6,366	6,366	6,780
FWNB-7840-V-P	78 x 32/40	2	1	6	5,466	6,575	6,575	6,993	5,928	-	5,923	6,993	6,993	7,436
FWNB-8444-V-P	84 x 32/44	2	1	8	6,068	7,215	7,215	7,647	6,547	-	6,540	7,647	7,647	8,106
FWNB-9044-V-P	90 x 32/44	2	1	8	6,601	7,806	7,806	8,262	7,104	-	7,097	8,262	8,262	8,744
FWNB-9648-V-P	96 x 36/48	2	1	8	7,086	8,292	8,292	8,746	7,589	8,746	7,582	8,746	8,746	9,228
FWNB-10248-V-P	102 x 36/48	2	1	8	7,726	8,999	8,999	9,479	8,257	9,479	8,249	9,479	9,479	9,988
FWNB-10848-V-P	108 x 36/48	2	1	10	7,973	9,245	9,245	9,725	8,504	9,725	8,497	9,725	9,725	10,235
FWNB-11450-V-P	114 x 36/50	2	1	10	9,222	10,621	10,621	11,149	9,806	11,149	9,797	11,149	11,149	11,708
FWNB-12050-V-P	120 x 36/50	2	1	10	9,503	10,902	10,902	11,430	10,086	11,430	10,079	11,430	11,430	11,990
FWNB-13254-V-P	132 x 36/54	2	2	10	10,930	12,388	12,388	12,938	11,538	12,938	11,529	12,938	12,938	13,521
FWNB-14454-V-P	144 x 36/54	2	2	12	12,019	13,535	13,535	14,106	12,651	14,106	12,643	14,106	14,106	14,712
FWNB-15654-V-P	156 x 36/54	3	2	12	15,062	17,358	17,358	18,225	16,020	18,225	16,007	18,225	18,225	19,143
FWNB-16860-V-P	168 x 42/60	3	2	14	17,585	20,003	20,003	20,916	18,593	20,916	18,580	20,916	20,916	21,884
FWNB-18060-V-P	180 x 42/60	3	2	14	18,432	20,850	20,850	21,763	19,440	21,763	19,427	21,763	21,763	22,731
FWNB-19272-V-P	192 x 54/72	3	4	18	25,827	28,392	28,392	29,360	-	29,360	26,883	29,360	29,360	30,386
FWNB-20472-V-P	204 x 54/72	3	4	18	28,131	30,801	30,801	31,808	-	31,808	29,229	31,808	31,808	32,876
FWNB-21672-V-P	216 x 54/72	3	4	20	30,104	32,839	32,839	33,870	-	33,870	31,230	33,870	33,870	34,965
FWNB-22872-V-P	228 x 54/72	3	4	20	31,689	34,450	34,450	35,491	-	35,491	32,825	35,491	35,491	36,596
FWNB-24072-V-P	240 x 54/72	3	4	20	33,361	36,153	36,153	37,206	-	37,206	34,510	37,206	37,206	38,323

**SIGHT LINE TABLES**

MODEL #	L x W	BASE QTY	TOP SECTIONS	SEATING CAPACITY	-PP	-P4	-PR	-PX	-TB	-HP	-VP	-V4	-VR	-VX
FWNA-7254-V-P	72 x 36/54	2	1	7	5,992	-	7,111	7,533	6,459	7,533	6,452	-	7,533	7,981
FWNA-7856-V-P	78 x 36/56	2	1	7	7,133	-	8,394	8,869	7,659	8,869	7,651	-	8,869	9,373
FWNA-8458-V-P	84 x 36/58	2	1	9	7,535	-	8,796	9,271	8,061	9,271	8,054	-	9,271	9,776
FWNA-9060-V-P	90 x 36/60	2	1	9	8,368	-	9,695	10,195	8,922	10,195	8,915	-	10,195	10,725
FWNA-9660-V-P	96 x 36/60	2	1	9	8,681	-	10,007	10,508	9,234	10,508	9,227	-	10,508	11,038
FWNA-10260-V-P	102 x 36/60	2	1	9	9,492	-	10,893	11,420	10,076	11,420	10,069	-	11,420	11,980
FWNA-10860-V-P	108 x 36/60	2	1	11	9,823	-	11,222	11,751	10,407	11,751	10,399	-	11,751	12,311
FWNA-11460-V-P	114 x 36/60	2	1	11	10,688	-	12,161	12,716	11,302	12,716	11,293	-	12,716	13,306
FWNA-12066-V-P	120 x 36/66	2	2	11	14,148	-	15,711	16,300	14,800	16,300	14,791	-	16,300	16,925
FWNA-13268-V-P	132 x 36/68	2	3	11	16,014	-	17,643	18,257	16,694	18,257	16,684	-	18,257	18,908
FWNA-14470-V-P	144 x 36/70	2	3	13	18,041	-	19,733	20,372	-	20,372	18,737	-	20,372	21,049
FWNA-15672-V-P	156 x 36/72	3	3	13	22,207	-	24,773	25,740	-	25,740	23,263	-	25,740	26,767
FWNA-16876-V-P	168 x 36/76	3	3	15	23,519	-	26,011	26,951	-	26,951	24,544	-	26,951	27,948
FWNA-18078-V-P	180 x 36/78	3	3	15	25,160	-	27,652	28,592	-	28,592	26,186	-	28,592	29,588
FWNA-19278-V-P	192 x 36/78	3	4	17	26,415	-	28,907	29,847	-	29,847	27,440	-	29,847	30,844
FWNA-20478-V-P	204 x 36/78	3	4	17	28,793	-	31,387	32,365	-	32,365	29,860	-	32,365	33,402
FWNA-21678-V-P	216 x 36/78	3	4	19	30,834	-	33,490	34,492	-	34,492	31,926	-	34,492	35,555
FWNA-22878-V-P	228 x 36/78	3	4	19	32,477	-	35,159	36,171	-	36,171	33,581	-	36,171	37,244
FWNA-24078-V-P	240 x 36/78	3	4	19	34,210	-	36,923	37,946	-	37,946	35,326	-	37,946	39,031



# INSET LAMINATE TOP WITH HARDWOOD EDGE

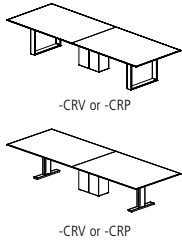

OPTIONS	CODE	PRICE	NOTES
Power and Data Options			See pages 119-129
<b>Remove Center Column for Four Post Base Options:</b>			
If -P4 base is selected	<b>-4COLP</b>	Deduct \$834	Tables 96" and shorter only
If -V4 base is selected	<b>-4COLV</b>	Deduct \$1,286	Tables 96" and shorter only
<b>Center Column Base Finish Options:</b>			
Painted Center Column Base*	Add <b>-CRP</b>	No Charge	To replace existing middle base (Hoop Base and T-Base only)
Veneer Center Column Base*	Add <b>-CRV</b>	No Charge	To replace existing middle base (Hoop Base and T-Base only)
<b>Polished Chrome Finish Options:</b>			
Polished Chrome Hoop Base (on 2 base tables)	Add <b>-PCHP2</b>	\$2,558	*When specifying -CRV or -CRP in conjunction with a Polished Chrome finish on Hoop Base or T-Base tables with 3 bases, use the upcharge code and pricing for 2 base tables (-PCHP2 or -PCTB2).
Polished Chrome Hoop Base (on 3 base tables)	Add <b>-PCHP3</b>	\$3,835	
Polished Chrome T-Base (on 2 base tables)	Add <b>-PCTB2</b>	\$2,558	
Polished Chrome T-Base (on 3 base tables)	Add <b>-PCTB3</b>	\$3,835	
T-Base Combination Finish (on 2 base tables)	Add <b>-PCCBF2</b>	\$1,566	
T-Base Combination Finish (on 3 base tables)	Add <b>-PCCBF3</b>	\$2,349	
<b>Multi-Section Tops:</b>			
102", 108", 114" and 120" one-piece tops split into two sections	Specify -2	\$761	Note: Power Matrix (center of table location only) cannot be specified when this option is selected

## EDGE PROFILE

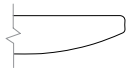

Reverse Flow Edge

## GENERAL INFORMATION

- Tops are 1-1/8"-thick with 3/16"-deep hardwood edge band
- Seating capacity based on 27" per person
- Overall table height 29.5"
- Four Post Base includes a 12"x24" center column for wire management. Center column may be removed from tables 96" and shorter with options -4COLP or -4COLV above. On tables over 96", the center column is required for support.
- T-Base combination finish includes a Polished Chrome foot and Powder Coat vertical column
- Beam finish will match Metal Finish selection. If no Metal Finish is selected, beams will be Foil.
- If Polished Chrome Finish is specified on the T-Base or Hoop Base, the beams will be Foil. If Polished Chrome Finish is specified on the Four Post Base, the beams will be Clear Anodized.
- Tables with three Hoop or T-Bases will default to the same base style for all three bases. An alternate Center Column Base may also be specified above.
- One wire manager included with the Hoop Base table (regardless of table size). Can be adhered to the leg and will default to the finish of the leg. If additional wire management channels are required, they can be purchased separately at the end of the pricelist.
- Center Wire Chase available on two base tables for more robust wire management needs. See page 128.
- Panel, Rectangle, Expandable Rectangle, Metal T-base, and Center Column bases have a removable access panel

### REQUIRED INFORMATION (ORDER CANNOT BE ENTERED WITHOUT THIS INFORMATION)

See appendix pages vi-vii for surface material options.

- Choose Veneer Finish
- Choose Laminate
- Choose Metal Finish. Clear Anodized (-CA) not available on T-Base or Hoop Base.
- Choose Paint Finish, if -PP, -P4, -PR, -PX or -CRP bases are selected



# LAMINATE TOP WITH ABS SQUARE EDGE

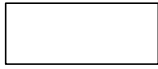

RECTANGLE TOP

### BASE KEY

PP	Painted Panel	TB	Metal T-Base
P4	Painted Four Post	HP	Metal Hoop
PR	Painted Rectangle		
PX	Painted Expandable Rectangle		
PN	Island		

### RECTANGLE TABLES

MODEL #	L x W	BASE QTY	TOP SECTIONS	SEATING CAPACITY	-PP	-P4	-PR	-PX	-PN	-TB	-HP
FWNT-7236-PE	72 x 36	2	1	6	-	5,295	5,295	5,675	-	4,708	-
FWNT-7242-PE	72 x 42	2	1	6	-	5,997	5,997	6,411	-	5,358	-
FWNT-7842-PE	78 x 42	2	1	6	-	6,594	6,594	7,036	-	5,910	-
FWNT-8442-PE	84 x 42	2	1	8	-	6,774	6,774	7,216	-	6,091	-
FWNT-8448-PE	84 x 48	2	1	8	6,103	7,316	7,316	7,774	-	6,609	7,774
FWNT-9042-PE	90 x 42	2	1	8	-	7,316	7,316	7,781	-	6,597	-
FWNT-9048-PE	90 x 48	2	1	8	6,640	7,915	7,915	8,397	-	7,172	8,397
FWNT-9642-PE	96 x 42	2	1	8	-	7,506	7,506	7,971	-	6,787	-
FWNT-9648-PE	96 x 48	2	1	8	6,859	8,135	8,135	8,616	-	7,391	8,616
FWNT-10242-PE	102 x 42	2	1	8	-	8,123	8,123	8,614	-	7,364	-
FWNT-10248-PE	102 x 48	2	1	8	7,472	8,819	8,819	9,327	-	8,034	9,327
FWNT-10842-PE	108 x 42	2	1	10	-	8,323	8,323	8,814	-	7,564	-
FWNT-10848-PE	108 x 48	2	1	10	7,703	9,050	9,050	9,558	-	8,265	9,558
FWNT-10854-PE	108 x 54	2	1	12	8,506	9,912	9,912	10,443	11,210	9,092	10,443
FWNT-11442-PE	114 x 42	2	1	10	-	8,973	8,973	9,489	-	8,174	-
FWNT-11448-PE	114 x 48	2	1	10	8,353	9,770	9,770	10,305	-	8,944	10,305
FWNT-11454-PE	114 x 54	2	1	12	9,235	10,716	10,716	11,274	12,082	9,853	11,274
FWNT-12042-PE	120 x 42	2	1	10	-	9,183	9,183	9,700	-	8,385	-
FWNT-12048-PE	120 x 48	2	1	10	8,597	10,014	10,014	10,549	-	9,188	10,549
FWNT-12054-PE	120 x 54	2	1	12	9,517	10,997	10,997	11,556	12,364	10,134	11,556
FWNT-13248-PE	132 x 48	2	2	10	9,464	10,940	10,940	11,497	-	10,080	11,497
FWNT-13254-PE	132 x 54	2	2	12	10,500	12,042	12,042	12,624	13,465	11,143	12,624
FWNT-14448-PE	144 x 48	2	2	12	10,370	11,906	11,906	12,485	-	11,011	12,485
FWNT-14454-PE	144 x 54	2	2	14	11,531	13,135	13,135	13,739	14,615	12,200	13,739
FWNT-14460-PE	144 x 60	2	2	14	12,880	14,569	14,569	15,206	16,128	13,584	15,206
FWNT-15648-PE	156 x 48	3	2	14	13,302	-	15,629	16,507	-	14,273	16,507
FWNT-15654-PE	156 x 54	3	2	14	14,659	17,089	17,089	18,006	16,455	15,673	18,006
FWNT-15660-PE	156 x 60	3	2	14	16,244	18,803	18,803	19,769	18,135	17,311	19,769
FWNT-16854-PE	168 x 54	3	2	16	15,362	17,792	17,792	18,709	17,158	16,375	18,709
FWNT-16860-PE	168 x 60	3	2	16	17,047	19,606	19,606	20,572	18,938	18,114	20,572
FWNT-18054-PE	180 x 54	3	2	16	16,065	18,496	18,496	19,412	23,616	17,079	19,412
FWNT-18060-PE	180 x 60	3	2	16	17,850	20,409	20,409	21,375	25,802	18,917	21,375
FWNT-19254-PE	192 x 54	3	2	18	16,769	19,200	19,200	20,116	24,320	17,783	20,116
FWNT-19260-PE	192 x 60	3	2	18	18,653	21,212	21,212	22,178	26,605	19,720	22,178
FWNT-19266-PE	192 x 66	3	4	18	23,319	26,033	26,033	27,057	31,753	-	27,057
FWNT-19272-PE	192 x 72	3	4	18	24,562	27,276	27,276	28,300	32,996	-	28,300
FWNT-20454-PE	204 x 54	3	2	18	18,182	20,711	20,711	21,665	26,039	19,237	21,665
FWNT-20460-PE	204 x 60	3	2	18	20,245	22,909	22,909	23,914	28,521	21,357	23,914
FWNT-20466-PE	204 x 66	3	4	18	25,356	28,181	28,181	29,247	34,133	-	29,247
FWNT-20472-PE	204 x 72	3	4	18	26,731	29,556	29,556	30,622	35,508	-	30,622
FWNT-21654-PE	216 x 54	3	2	20	19,375	21,966	21,966	22,943	27,424	20,456	22,943
FWNT-21660-PE	216 x 60	3	2	20	21,594	24,323	24,323	25,352	30,071	22,732	25,352
FWNT-21666-PE	216 x 66	3	4	20	27,093	29,987	29,987	31,078	36,084	-	31,078
FWNT-21672-PE	216 x 72	3	4	20	28,584	31,478	31,478	32,569	37,575	-	32,569
FWNT-22854-PE	228 x 54	3	2	20	20,316	22,932	22,932	23,918	28,442	21,408	23,918
FWNT-22860-PE	228 x 60	3	2	20	22,664	25,418	25,418	26,457	31,222	23,813	26,457
FWNT-22866-PE	228 x 66	3	4	20	28,479	31,400	31,400	32,502	37,555	-	32,502
FWNT-22872-PE	228 x 72	3	4	20	30,068	32,989	32,989	34,091	39,144	-	34,091
FWNT-24054-PE	240 x 54	3	2	20	21,312	23,957	23,957	24,954	29,529	22,415	24,954
FWNT-24060-PE	240 x 60	3	2	20	23,795	26,580	26,580	27,631	32,449	24,957	27,631
FWNT-24066-PE	240 x 66	3	4	20	29,943	32,898	32,898	34,012	39,122	-	34,012
FWNT-24072-PE	240 x 72	3	4	20	31,634	34,589	34,589	35,703	40,813	-	35,703



# LAMINATE TOP WITH ABS SQUARE EDGE

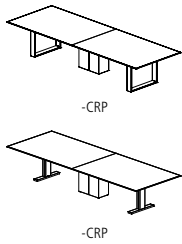

OPTIONS	CODE	PRICE	NOTES
Power and Data Options			See pages 119-129
<b>Remove Center Column for Four Post Base Options:</b> If -P4 base is selected	<b>-4COLP</b>	Deduct \$834	Tables 96" and shorter only
<b>Center Column Base Finish Options:</b> Painted Center Column Base*	Add <b>-CRP</b>	No Charge	To replace existing middle base (Hoop Base and T-Base only)
<b>Polished Chrome Finish Options:</b> Polished Chrome Four Post Base Polished Chrome Hoop Base (on 2 base tables) Polished Chrome Hoop Base (on 3 base tables) Polished Chrome T-Base (on 2 base tables) Polished Chrome T-Base (on 3 base tables) T-Base Combination Finish (on 2 base tables) T-Base Combination Finish (on 3 base tables)	Add <b>-PCFB</b> Add <b>-PCHP2</b> Add <b>-PCHP3</b> Add <b>-PCTB2</b> Add <b>-PCTB3</b> Add <b>-PCCBF2</b> Add <b>-PCCBF3</b>	\$2,558 \$2,558 \$3,835 \$2,558 \$3,835 \$1,566 \$2,349	*When specifying -CRV or -CRP in conjunction with a Polished Chrome finish on Hoop Base or T-Base tables with 3 bases, use the upcharge code and pricing for 2 base tables (-PCHP2 or -PCTB2).
<b>Multi-Section Tops:</b> 102", 108", 114" and 120" one-piece tops split into two sections	Specify -2	\$761	Note: Power Matrix (center of table location only) cannot be specified when this option is selected
204", 216", 228" or 240" two-piece tops split into four sections	Specify -4	\$1,517	

## EDGE PROFILE



ABS Square Edge

## GENERAL INFORMATION

- Tops are 1-1/8"-thick with 2mm ABS edge
- Seating capacity based on 27" per person
- Overall table height 29.5"
- Four Post Base includes a 12"x24" center column for wire management. Center column may be removed from tables 96" and shorter with options -4COLP or -4COLV above. On tables over 96", the center column is required for support.
- T-Base combination finish includes a Polished Chrome foot and Powder Coat vertical column
- Beam finish will match Metal Finish selection. If no Metal Finish is selected, beams will be Foil.
- If Polished Chrome Finish is specified on the T-Base or Hoop Base, the beams will be Foil. If Polished Chrome Finish is specified on the Four Post Base, the beams will be Clear Anodized.
- Tables with three Hoop or T-Bases will default to the same base style for all three bases. An alternate Center Column Base may also be specified above.
- One wire manager included with the Hoop Base table (regardless of table size). Can be adhered to the leg and will default to the finish of the leg. If additional wire management channels are required, they can be purchased separately at the end of the pricelist.
- Center Wire Chase available on two base tables for more robust wire management needs. See page 128.
- Panel, Rectangle, Expandable Rectangle, Island, Metal T-base, and Center Column bases have a removable access panel

### REQUIRED INFORMATION (ORDER CANNOT BE ENTERED WITHOUT THIS INFORMATION)

See appendix pages vi-vii for surface material options.

- Choose Laminate
- Choose ABS Color
- Choose Metal Finish. Clear Anodized (-CA) not available on T-Base or Hoop Base.
- Choose Paint Finish, if -PP, -P4, -PR, -PX, -PN or -CRP bases are selected





# LAMINATE TOP WITH ABS SQUARE EDGE

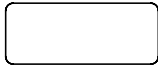

RADIUS RECTANGLE TOP

**BASE KEY**

PP	Painted Panel	TB	Metal T-Base
PR	Painted Rectangle	HP	Metal Hoop
PX	Painted Expandable Rectangle		
PN	Island		

**RADIUS RECTANGLE TABLES**

MODEL #	L x W	BASE QTY	TOP SECTIONS	SEATING CAPACITY	-PP	-PR	-PX	-PN	-TB	-HP
FWNC-7236-PE	72 x 36	2	1	6	-	5,295	5,675	-	4,708	-
FWNC-7242-PE	72 x 42	2	1	6	-	5,997	6,411	-	5,358	-
FWNC-7842-PE	78 x 42	2	1	6	-	6,594	7,036	-	5,910	-
FWNC-8442-PE	84 x 42	2	1	8	-	6,774	7,216	-	6,091	-
FWNC-8448-PE	84 x 48	2	1	8	6,103	7,316	7,774	-	6,609	7,774
FWNC-9042-PE	90 x 42	2	1	8	-	7,316	7,781	-	6,597	-
FWNC-9048-PE	90 x 48	2	1	8	6,640	7,915	8,397	-	7,172	8,397
FWNC-9642-PE	96 x 42	2	1	8	-	7,506	7,971	-	6,787	-
FWNC-9648-PE	96 x 48	2	1	8	6,859	8,135	8,616	-	7,391	8,616
FWNC-10242-PE	102 x 42	2	1	8	-	8,123	8,614	-	7,364	-
FWNC-10248-PE	102 x 48	2	1	8	7,472	8,819	9,327	-	8,034	9,327
FWNC-10842-PE	108 x 42	2	1	10	-	8,323	8,814	-	7,564	-
FWNC-10848-PE	108 x 48	2	1	10	7,703	9,050	9,558	-	8,265	9,558
FWNC-10854-PE	108 x 54	2	1	12	8,506	9,912	10,443	11,210	9,092	10,443
FWNC-11442-PE	114 x 42	2	1	10	-	8,973	9,489	-	8,174	-
FWNC-11448-PE	114 x 48	2	1	10	8,353	9,770	10,305	-	8,944	10,305
FWNC-11454-PE	114 x 54	2	1	12	9,235	10,716	11,274	12,082	9,853	11,274
FWNC-12042-PE	120 x 42	2	1	10	-	9,183	9,700	-	8,385	-
FWNC-12048-PE	120 x 48	2	1	10	8,597	10,014	10,549	-	9,188	10,549
FWNC-12054-PE	120 x 54	2	1	12	9,517	10,997	11,556	12,364	10,134	11,556
FWNC-13248-PE	132 x 48	2	2	10	9,464	10,940	11,497	-	10,080	11,497
FWNC-13254-PE	132 x 54	2	2	12	10,500	12,042	12,624	13,465	11,143	12,624
FWNC-14448-PE	144 x 48	2	2	12	10,370	11,906	12,485	-	11,011	12,485
FWNC-14454-PE	144 x 54	2	2	14	11,531	13,135	13,739	14,615	12,200	13,739
FWNC-14460-PE	144 x 60	2	2	14	12,880	14,569	15,206	16,128	13,584	15,206
FWNC-15648-PE	156 x 48	3	2	14	13,302	15,629	16,507	-	14,273	16,507
FWNC-15654-PE	156 x 54	3	2	14	14,659	17,089	18,006	16,455	15,673	18,006
FWNC-15660-PE	156 x 60	3	2	14	16,244	18,803	19,769	18,135	17,311	19,769
FWNC-16854-PE	168 x 54	3	2	16	15,362	17,792	18,709	17,158	16,375	18,709
FWNC-16860-PE	168 x 60	3	2	16	17,047	19,606	20,572	18,938	18,114	20,572
FWNC-18054-PE	180 x 54	3	2	16	16,065	18,496	19,412	23,616	17,079	19,412
FWNC-18060-PE	180 x 60	3	2	16	17,850	20,409	21,375	25,802	18,917	21,375
FWNC-19254-PE	192 x 54	3	2	18	16,769	19,200	20,116	24,320	17,783	20,116
FWNC-19260-PE	192 x 60	3	2	18	18,653	21,212	22,178	26,605	19,720	22,178
FWNC-19266-PE	192 x 66	3	4	18	23,319	26,033	27,057	31,753	-	27,057
FWNC-19272-PE	192 x 72	3	4	18	24,562	27,276	28,300	32,996	-	28,300
FWNC-20454-PE	204 x 54	3	2	18	18,182	20,711	21,665	26,039	19,237	21,665
FWNC-20460-PE	204 x 60	3	2	18	20,245	22,909	23,914	28,521	21,357	23,914
FWNC-20466-PE	204 x 66	3	4	18	25,356	28,181	29,247	34,133	-	29,247
FWNC-20472-PE	204 x 72	3	4	18	26,731	29,556	30,622	35,508	-	30,622
FWNC-21654-PE	216 x 54	3	2	20	19,375	21,966	22,943	27,424	20,456	22,943
FWNC-21660-PE	216 x 60	3	2	20	21,594	24,323	25,352	30,071	22,732	25,352
FWNC-21666-PE	216 x 66	3	4	20	27,093	29,987	31,078	36,084	-	31,078
FWNC-21672-PE	216 x 72	3	4	20	28,584	31,478	32,569	37,575	-	32,569
FWNC-22854-PE	228 x 54	3	2	20	20,316	22,932	23,918	28,442	21,408	23,918
FWNC-22860-PE	228 x 60	3	2	20	22,664	25,418	26,457	31,222	23,813	26,457
FWNC-22866-PE	228 x 66	3	4	20	28,479	31,400	32,502	37,555	-	32,502
FWNC-22872-PE	228 x 72	3	4	20	30,068	32,989	34,091	39,144	-	34,091
FWNC-24054-PE	240 x 54	3	2	20	21,312	23,957	24,954	29,529	22,415	24,954
FWNC-24060-PE	240 x 60	3	2	20	23,795	26,580	27,631	32,449	24,957	27,631
FWNC-24066-PE	240 x 66	3	4	20	29,943	32,898	34,012	39,122	-	34,012
FWNC-24072-PE	240 x 72	3	4	20	31,634	34,589	35,703	40,813	-	35,703



# LAMINATE TOP WITH ABS SQUARE EDGE

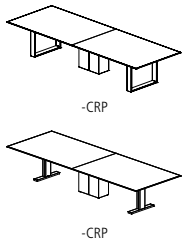

OPTIONS	CODE	PRICE	NOTES
Power and Data Options			See pages 119-129
<b>Remove Center Column for Four Post Base Options:</b> If -P4 base is selected	<b>-4COLP</b>	Deduct \$834	Tables 96" and shorter only
<b>Center Column Base Finish Options:</b> Painted Center Column Base*	Add <b>-CRP</b>	No Charge	To replace existing middle base (Hoop Base and T-Base only)
<b>Polished Chrome Finish Options:</b> Polished Chrome Hoop Base (on 2 base tables) Polished Chrome Hoop Base (on 3 base tables) Polished Chrome T-Base (on 2 base tables) Polished Chrome T-Base (on 3 base tables) T-Base Combination Finish (on 2 base tables) T-Base Combination Finish (on 3 base tables)	Add <b>-PCHP2</b> Add <b>-PCHP3</b> Add <b>-PCTB2</b> Add <b>-PCTB3</b> Add <b>-PCCBF2</b> Add <b>-PCCBF3</b>	\$2,558 \$3,835 \$2,558 \$3,835 \$1,566 \$2,349	*When specifying -CRV or -CRP in conjunction with a Polished Chrome finish on Hoop Base or T-Base tables with 3 bases, use the upcharge code and pricing for 2 base tables (-PCHP2 or -PCTB2).
<b>Multi-Section Tops:</b> 102", 108", 114" and 120" one-piece tops split into two sections	Specify -2	\$761	Note: Power Matrix (center of table location only) cannot be specified when this option is selected
204", 216", 228" or 240" two-piece tops split into four sections	Specify -4	\$1,517	

## EDGE PROFILE



ABS Square Edge

## GENERAL INFORMATION

- Tops are 1-1/8"-thick with 3/16"-deep hardwood edge band
- Seating capacity based on 27" per person
- Overall table height 29.5"
- T-Base combination finish includes a Polished Chrome foot and Powder Coat vertical column
- Beam finish will match Metal Finish selection. If no Metal Finish is selected, beams will be Foil.
- If Polished Chrome Finish is specified on the T-Base or Hoop Base, the beams will be Foil. If Polished Chrome Finish is specified on the Four Post Base, the beams will be Clear Anodized.
- Tables with three Hoop or T-Bases will default to the same base style for all three bases. An alternate Center Column Base may also be specified above.
- One wire manager included with the Hoop Base table (regardless of table size). Can be adhered to the leg and will default to the finish of the leg. If additional wire management channels are required, they can be purchased separately at the end of the pricelist.
- Center Wire Chase available on two base tables for more robust wire management needs. See page 128.
- Panel, Rectangle, Expandable Rectangle, Island, Metal T-base, and Center Column bases have a removable access panel

### REQUIRED INFORMATION (ORDER CANNOT BE ENTERED WITHOUT THIS INFORMATION)

See appendix pages vi-vii for surface material options.

- Choose Laminate
- Choose ABS Color
- Choose Metal Finish. Clear Anodized (-CA) not available on T-Base or Hoop Base.
- Choose Paint Finish, if -PP, -PR, -PX, -PN or -CRP bases are selected



# LAMINATE TOP WITH ABS SQUARE EDGE

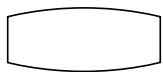

BOAT TOP

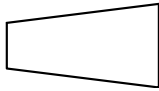

SIGHT LINE TOP

**BASE KEY**

PP	Painted Panel	TB	Metal T-Base
P4	Painted Four Post	HP	Metal Hoop
PR	Painted Rectangle		
PX	Painted Expandable Rectangle		

**BOAT TABLES**

MODEL #	L x W	BASE QTY	TOP SECTIONS	SEATING CAPACITY	-PP	-P4	-PR	-PX	-TB	-HP
FWNB-7240-PE	72 x 32/40	2	1	6	4,821	5,917	5,917	6,331	5,278	-
FWNB-7840-PE	78 x 32/40	2	1	6	5,329	6,502	6,502	6,944	5,818	-
FWNB-8444-PE	84 x 32/44	2	1	8	5,897	7,110	7,110	7,568	6,403	-
FWNB-9044-PE	90 x 32/44	2	1	8	6,408	7,683	7,683	8,165	6,940	-
FWNB-9648-PE	96 x 36/48	2	1	8	6,859	8,135	8,135	8,616	7,391	8,616
FWNB-10248-PE	102 x 36/48	2	1	8	7,472	8,819	8,819	9,327	8,034	9,327
FWNB-10848-PE	108 x 36/48	2	1	10	7,703	9,050	9,050	9,558	8,265	9,558
FWNB-11450-PE	114 x 36/50	2	1	10	8,894	10,375	10,375	10,933	9,512	10,933
FWNB-12050-PE	120 x 36/50	2	1	10	9,158	10,638	10,638	11,197	9,775	11,197
FWNB-13254-PE	132 x 36/54	2	2	10	10,500	12,042	12,042	12,624	11,143	12,624
FWNB-14454-PE	144 x 36/54	2	2	12	11,531	13,135	13,135	13,739	12,200	13,739
FWNB-15654-PE	156 x 36/54	3	2	12	14,659	17,089	17,089	18,006	15,673	18,006
FWNB-16860-PE	168 x 42/60	3	2	14	17,047	19,606	19,606	20,572	18,114	20,572
FWNB-18060-PE	180 x 42/60	3	2	14	17,850	20,409	20,409	21,375	18,917	21,375
FWNB-19272-PE	192 x 54/72	3	4	18	24,562	27,276	27,276	28,300	-	28,300
FWNB-20472-PE	204 x 54/72	3	4	18	26,731	29,556	29,556	30,622	-	30,622
FWNB-21672-PE	216 x 54/72	3	4	20	28,584	31,478	31,478	32,569	-	32,569
FWNB-22872-PE	228 x 54/72	3	4	20	30,068	32,989	32,989	34,091	-	34,091
FWNB-24072-PE	240 x 54/72	3	4	20	31,634	34,589	34,589	35,703	-	35,703

**SIGHT LINE TABLES**

MODEL #	L x W	BASE QTY	TOP SECTIONS	SEATING CAPACITY	-PP	-P4	-PR	-PX	-TB	-HP
FWNA-7254-PE	72 x 36/54	2	1	7	5,811	-	6,995	7,442	6,305	7,442
FWNA-7856-PE	78 x 36/56	2	1	7	6,904	-	8,238	8,741	7,460	8,741
FWNA-8458-PE	84 x 36/58	2	1	9	7,278	-	8,612	9,115	7,835	9,115
FWNA-9060-PE	90 x 36/60	2	1	9	8,068	-	9,472	10,001	8,654	10,001
FWNA-9660-PE	96 x 36/60	2	1	9	8,361	-	9,764	10,294	8,946	10,294
FWNA-10260-PE	102 x 36/60	2	1	9	9,133	-	10,615	11,173	9,751	11,173
FWNA-10860-PE	108 x 36/60	2	1	11	9,442	-	10,923	11,482	10,060	11,482
FWNA-11460-PE	114 x 36/60	2	1	11	10,264	-	11,823	12,411	10,914	12,411
FWNA-12066-PE	120 x 36/66	2	2	11	13,381	-	15,035	15,658	14,071	15,658
FWNA-13268-PE	132 x 36/68	2	3	11	15,115	-	16,838	17,488	15,834	17,488
FWNA-14470-PE	144 x 36/70	2	3	13	16,995	-	18,786	19,462	-	19,462
FWNA-15672-PE	156 x 36/72	3	3	13	21,182	-	23,897	24,921	-	24,921
FWNA-16876-PE	168 x 36/76	3	3	15	22,376	-	25,013	26,008	-	26,008
FWNA-18078-PE	180 x 36/78	3	3	15	23,898	-	26,535	27,530	-	27,530
FWNA-19278-PE	192 x 36/78	3	4	17	25,067	-	27,704	28,699	-	28,699
FWNA-20478-PE	204 x 36/78	3	4	17	27,302	-	30,047	31,082	-	31,082
FWNA-21678-PE	216 x 36/78	3	4	19	29,215	-	32,026	33,086	-	33,086
FWNA-22878-PE	228 x 36/78	3	4	19	30,751	-	33,589	34,660	-	34,660
FWNA-24078-PE	240 x 36/78	3	4	19	32,373	-	35,243	36,326	-	36,326



# LAMINATE TOP WITH ABS SQUARE EDGE

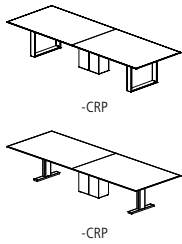

OPTIONS	CODE	PRICE	NOTES
Power and Data Options			See pages 119-129
<b>Remove Center Column for Four Post Base Options:</b> If -P4 base is selected	<b>-4COLP</b>	Deduct \$834	Tables 96" and shorter only
<b>Center Column Base Finish Options:</b> Painted Center Column Base*	Add <b>-CRP</b>	No Charge	To replace existing middle base (Hoop Base and T-Base only)
<b>Polished Chrome Finish Options:</b> Polished Chrome Hoop Base (on 2 base tables)	Add <b>-PCHP2</b>	\$2,558	*When specifying -CRV or -CRP in conjunction with a Polished Chrome finish on Hoop Base or T-Base tables with 3 bases, use the upcharge code and pricing for 2 base tables (-PCHP2 or -PCTB2).
Polished Chrome Hoop Base (on 3 base tables)	Add <b>-PCHP3</b>	\$3,835	
Polished Chrome T-Base (on 2 base tables)	Add <b>-PCTB2</b>	\$2,558	
Polished Chrome T-Base (on 3 base tables)	Add <b>-PCTB3</b>	\$3,835	
T-Base Combination Finish (on 2 base tables)	Add <b>-PCCBF2</b>	\$1,566	
T-Base Combination Finish (on 3 base tables)	Add <b>-PCCBF3</b>	\$2,349	
<b>Multi-Section Tops:</b> 102", 108", 114" and 120" one-piece tops split into two sections	Specify -2	\$761	Note: Power Matrix (center of table location only) cannot be specified when this option is selected

## EDGE PROFILE



ABS Square Edge

## GENERAL INFORMATION

- Tops are 1-1/8"-thick with 3/16"-deep hardwood edge band
- Seating capacity based on 27" per person
- Overall table height 29.5"
- Four Post Base includes a 12"x24" center column for wire management. Center column may be removed from tables 96" and shorter with options -4COLP or -4COLV above. On tables over 96", the center column is required for support.
- T-Base combination finish includes a Polished Chrome foot and Powder Coat vertical column
- Beam finish will match Metal Finish selection. If no Metal Finish is selected, beams will be Foil.
- If Polished Chrome Finish is specified on the T-Base or Hoop Base, the beams will be Foil. If Polished Chrome Finish is specified on the Four Post Base, the beams will be Clear Anodized.
- Tables with three Hoop or T-Bases will default to the same base style for all three bases. An alternate Center Column Base may also be specified above.
- One wire manager included with the Hoop Base table (regardless of table size). Can be adhered to the leg and will default to the finish of the leg. If additional wire management channels are required, they can be purchased separately at the end of the pricelist.
- Center Wire Chase available on two base tables for more robust wire management needs. See page 128.
- Panel, Rectangle, Expandable Rectangle, Metal T-base, and Center Column bases have a removable access panel

### REQUIRED INFORMATION (ORDER CANNOT BE ENTERED WITHOUT THIS INFORMATION)

See appendix pages vi-vii for surface material options.

- Choose Laminate
- Choose ABS Color
- Choose Metal Finish. Clear Anodized (-CA) not available on T-Base or Hoop Base.
- Choose Paint Finish, if -PP, -P4, -PR, -PX or -CRP bases are selected



# LAMINATE TOP WITH ABS REVERSE FLOW EDGE

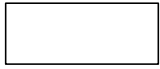

RECTANGLE TOP

**BASE KEY**

PP	Painted Panel	TB	Metal T-Base
P4	Painted Four Post	HP	Metal Hoop
PR	Painted Rectangle		
PX	Painted Expandable Rectangle		
PN	Island		

**RECTANGLE TABLES**

MODEL #	L x W	BASE QTY	TOP SECTIONS	SEATING CAPACITY	-PP	-P4	-PR	-PX	-PN	-TB	-HP
FWNT-7236-PA	72 x 36	2	1	6	-	5,336	5,336	5,695	-	4,781	-
FWNT-7242-PA	72 x 42	2	1	6	-	6,062	6,062	6,453	-	5,458	-
FWNT-7842-PA	78 x 42	2	1	6	-	6,675	6,675	7,093	-	6,029	-
FWNT-8442-PA	84 x 42	2	1	8	-	6,866	6,866	7,284	-	6,220	-
FWNT-8448-PA	84 x 48	2	1	8	6,291	7,438	7,438	7,870	-	6,770	7,870
FWNT-9042-PA	90 x 42	2	1	8	-	7,424	7,424	7,864	-	6,745	-
FWNT-9048-PA	90 x 48	2	1	8	6,853	8,058	8,058	8,513	-	7,355	8,513
FWNT-9642-PA	96 x 42	2	1	8	-	7,626	7,626	8,065	-	6,946	-
FWNT-9648-PA	96 x 48	2	1	8	7,086	8,292	8,292	8,746	-	7,589	8,746
FWNT-10242-PA	102 x 42	2	1	8	-	8,263	8,263	8,727	-	7,545	-
FWNT-10248-PA	102 x 48	2	1	8	7,726	8,999	8,999	9,479	-	8,257	9,479
FWNT-10842-PA	108 x 42	2	1	10	-	8,475	8,475	8,939	-	7,758	-
FWNT-10848-PA	108 x 48	2	1	10	7,973	9,245	9,245	9,725	-	8,504	9,725
FWNT-10854-PA	108 x 54	2	1	12	8,828	10,156	10,156	10,658	11,383	9,382	10,658
FWNT-11442-PA	114 x 42	2	1	10	-	9,145	9,145	9,633	-	8,390	-
FWNT-11448-PA	114 x 48	2	1	10	8,653	9,992	9,992	10,498	-	9,211	10,498
FWNT-11454-PA	114 x 54	2	1	12	9,592	10,992	10,992	11,519	12,283	10,176	11,519
FWNT-12042-PA	120 x 42	2	1	10	-	9,369	9,369	9,858	-	8,615	-
FWNT-12048-PA	120 x 48	2	1	10	8,913	10,252	10,252	10,757	-	9,471	10,757
FWNT-12054-PA	120 x 54	2	1	12	9,893	11,291	11,291	11,820	12,583	10,476	11,820
FWNT-13248-PA	132 x 48	2	2	10	9,825	11,220	11,220	11,746	-	10,407	11,746
FWNT-13254-PA	132 x 54	2	2	12	10,930	12,388	12,388	12,938	13,732	11,538	12,938
FWNT-14448-PA	144 x 48	2	2	12	10,780	12,232	12,232	12,779	-	11,386	12,779
FWNT-14454-PA	144 x 54	2	2	14	12,019	13,535	13,535	14,106	14,933	12,651	14,106
FWNT-14460-PA	144 x 60	2	2	14	13,458	15,054	15,054	15,656	16,528	14,124	15,656
FWNT-15648-PA	156 x 48	3	2	14	13,625	-	15,824	16,653	-	14,542	16,653
FWNT-15654-PA	156 x 54	3	2	14	15,062	17,358	17,358	18,225	16,759	16,020	18,225
FWNT-15660-PA	156 x 60	3	2	14	16,738	19,157	19,157	20,069	18,525	17,747	20,069
FWNT-16854-PA	168 x 54	3	2	16	15,802	18,098	18,098	18,965	17,499	16,759	18,965
FWNT-16860-PA	168 x 60	3	2	16	17,585	20,003	20,003	20,916	19,372	18,593	20,916
FWNT-18054-PA	180 x 54	3	2	16	16,541	18,838	18,838	19,704	23,677	17,499	19,704
FWNT-18060-PA	180 x 60	3	2	16	18,432	20,850	20,850	21,763	25,946	19,440	21,763
FWNT-19254-PA	192 x 54	3	2	18	17,281	19,578	19,578	20,444	24,416	18,239	20,444
FWNT-19260-PA	192 x 60	3	2	18	19,278	21,697	21,697	22,610	26,793	20,287	22,610
FWNT-19266-PA	192 x 66	3	4	18	24,464	27,028	27,028	27,996	32,434	-	27,996
FWNT-19272-PA	192 x 72	3	4	18	25,827	28,392	28,392	29,360	33,797	-	29,360
FWNT-20454-PA	204 x 54	3	2	18	18,752	21,142	21,142	22,044	26,177	19,749	22,044
FWNT-20460-PA	204 x 60	3	2	18	20,941	23,458	23,458	24,408	28,762	21,992	24,408
FWNT-20466-PA	204 x 66	3	4	18	26,623	29,293	29,293	30,300	34,917	-	30,300
FWNT-20472-PA	204 x 72	3	4	18	28,131	30,801	30,801	31,808	36,426	-	31,808
FWNT-21654-PA	216 x 54	3	2	20	19,999	22,447	22,447	23,370	27,605	21,020	23,370
FWNT-21660-PA	216 x 60	3	2	20	22,354	24,933	24,933	25,906	30,365	23,430	25,906
FWNT-21666-PA	216 x 66	3	4	20	28,468	31,203	31,203	32,234	36,964	-	32,234
FWNT-21672-PA	216 x 72	3	4	20	30,104	32,839	32,839	33,870	38,601	-	33,870
FWNT-22854-PA	228 x 54	3	2	20	20,984	23,456	23,456	24,388	28,663	22,016	24,388
FWNT-22860-PA	228 x 60	3	2	20	23,479	26,082	26,082	27,063	31,566	24,565	27,063
FWNT-22866-PA	228 x 66	3	4	20	29,946	32,706	32,706	33,747	38,522	-	33,747
FWNT-22872-PA	228 x 72	3	4	20	31,689	34,450	34,450	35,491	40,266	-	35,491
FWNT-24054-PA	240 x 54	3	2	20	22,028	24,528	24,528	25,470	29,794	23,071	25,470
FWNT-24060-PA	240 x 60	3	2	20	24,666	27,298	27,298	28,291	32,844	25,764	28,291
FWNT-24066-PA	240 x 66	3	4	20	31,505	34,297	34,297	35,350	40,179	-	35,350
FWNT-24072-PA	240 x 72	3	4	20	33,361	36,153	36,153	37,206	42,035	-	37,206



# LAMINATE TOP WITH ABS REVERSE FLOW EDGE

OPTIONS	CODE	PRICE	NOTES
Power and Data Options			See pages 119-129
<b>Remove Center Column for Four Post Base Options:</b> If -P4 base is selected	<b>-4COLP</b>	Deduct \$834	Tables 96" and shorter only
<b>Center Column Base Finish Options:</b> Painted Center Column Base*	Add <b>-CRP</b>	No Charge	To replace existing middle base (Hoop Base and T-Base only)
<b>Polished Chrome Finish Options:</b> Polished Chrome Four Post Base Polished Chrome Hoop Base (on 2 base tables) Polished Chrome Hoop Base (on 3 base tables) Polished Chrome T-Base (on 2 base tables) Polished Chrome T-Base (on 3 base tables) T-Base Combination Finish (on 2 base tables) T-Base Combination Finish (on 3 base tables)	Add <b>-PCFB</b> Add <b>-PCHP2</b> Add <b>-PCHP3</b> Add <b>-PCTB2</b> Add <b>-PCTB3</b> Add <b>-PCCBF2</b> Add <b>-PCCBF3</b>	\$2,558 \$2,558 \$3,835 \$2,558 \$3,835 \$1,566 \$2,349	*When specifying -CRV or -CRP in conjunction with a Polished Chrome finish on Hoop Base or T-Base tables with 3 bases, use the upcharge code and pricing for 2 base tables (-PCHP2 or -PCTB2).
<b>Multi-Section Tops:</b> 102", 108", 114" and 120" one-piece tops split into two sections	Specify -2	\$761	Note: Power Matrix (center of table location only) cannot be specified when this option is selected
204", 216", 228" or 240" two-piece tops split into four sections	Specify -4	\$1,517	

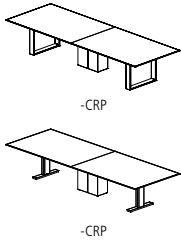

## EDGE PROFILE

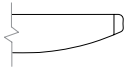

ABS Reverse Flow Edge

## GENERAL INFORMATION

- Tops are 1-1/8" thick with 2mm ABS edge
- Seating capacity based on 27" per person
- Overall table height 29.5"
- Four Post Base includes a 12"x24" center column for wire management. Center column may be removed from tables 96" and shorter with options -4COLP or -4COLV above. On tables over 96", the center column is required for support.
- T-Base combination finish includes a Polished Chrome foot and Powder Coat vertical column
- Beam finish will match Metal Finish selection. If no Metal Finish is selected, beams will be Foil.
- If Polished Chrome Finish is specified on the T-Base or Hoop Base, the beams will be Foil. If Polished Chrome Finish is specified on the Four Post Base, the beams will be Clear Anodized.
- Underside of table edge is painted to match ABS color
- Tables with three Hoop or T-Bases will default to the same base style for all three bases. An alternate Center Column Base may also be specified above.
- One wire manager included with the Hoop Base table (regardless of table size). Can be adhered to the leg and will default to the finish of the leg. If additional wire management channels are required, they can be purchased separately at the end of the pricelist.
- Center Wire Chase available on two base tables for more robust wire management needs. See page 128.
- Panel, Rectangle, Expandable Rectangle, Island, Metal T-base, and Center Column bases have a removable access panel

### REQUIRED INFORMATION (ORDER CANNOT BE ENTERED WITHOUT THIS INFORMATION)

See appendix pages vi-vii for surface material options.

- Choose Laminate
- Choose ABS Color
- Choose Metal Finish. Clear Anodized (-CA) not available on T-Base or Hoop Base.
- Choose Paint Finish, if -PP, -P4, -PR, -PX, -PN or -CRP bases are selected



# LAMINATE TOP WITH ABS REVERSE FLOW EDGE

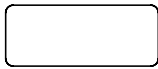

RADIUS RECTANGLE TOP

**BASE KEY**

PP	Painted Panel	TB	Metal T-Base
PR	Painted Rectangle	HP	Metal Hoop
PX	Painted Expandable Rectangle		
PN	Island		

**RADIUS RECTANGLE TABLES**

MODEL #	L x W	BASE QTY	TOP SECTIONS	SEATING CAPACITY	-PP	-PR	-PX	-PN	-TB	-HP
FWNC-7236-PA	72 x 36	2	1	6	-	5,336	5,695	-	4,781	-
FWNC-7242-PA	72 x 42	2	1	6	-	6,062	6,453	-	5,458	-
FWNC-7842-PA	78 x 42	2	1	6	-	6,675	7,093	-	6,029	-
FWNC-8442-PA	84 x 42	2	1	8	-	6,866	7,284	-	6,220	-
FWNC-8448-PA	84 x 48	2	1	8	6,291	7,438	7,870	-	6,770	7,870
FWNC-9042-PA	90 x 42	2	1	8	-	7,424	7,864	-	6,745	-
FWNC-9048-PA	90 x 48	2	1	8	6,853	8,058	8,513	-	7,355	8,513
FWNC-9642-PA	96 x 42	2	1	8	-	7,626	8,065	-	6,946	-
FWNC-9648-PA	96 x 48	2	1	8	7,086	8,292	8,746	-	7,589	8,746
FWNC-10242-PA	102 x 42	2	1	8	-	8,263	8,727	-	7,545	-
FWNC-10248-PA	102 x 48	2	1	8	7,726	8,999	9,479	-	8,257	9,479
FWNC-10842-PA	108 x 42	2	1	10	-	8,475	8,939	-	7,758	-
FWNC-10848-PA	108 x 48	2	1	10	7,973	9,245	9,725	-	8,504	9,725
FWNC-10854-PA	108 x 54	2	1	12	8,828	10,156	10,658	11,383	9,382	10,658
FWNC-11442-PA	114 x 42	2	1	10	-	9,145	9,633	-	8,390	-
FWNC-11448-PA	114 x 48	2	1	10	8,653	9,992	10,498	-	9,211	10,498
FWNC-11454-PA	114 x 54	2	1	12	9,592	10,992	11,519	12,283	10,176	11,519
FWNC-12042-PA	120 x 42	2	1	10	-	9,369	9,858	-	8,615	-
FWNC-12048-PA	120 x 48	2	1	10	8,913	10,252	10,757	-	9,471	10,757
FWNC-12054-PA	120 x 54	2	1	12	9,893	11,291	11,820	12,583	10,476	11,820
FWNC-13248-PA	132 x 48	2	2	10	9,825	11,220	11,746	-	10,407	11,746
FWNC-13254-PA	132 x 54	2	2	12	10,930	12,388	12,938	13,732	11,538	12,938
FWNC-14448-PA	144 x 48	2	2	12	10,780	12,232	12,779	-	11,386	12,779
FWNC-14454-PA	144 x 54	2	2	14	12,019	13,535	14,106	14,933	12,651	14,106
FWNC-14460-PA	144 x 60	2	2	14	13,458	15,054	15,656	16,528	14,124	15,656
FWNC-15648-PA	156 x 48	3	2	14	13,625	15,824	16,653	-	14,542	16,653
FWNC-15654-PA	156 x 54	3	2	14	15,062	17,358	18,225	16,759	16,020	18,225
FWNC-15660-PA	156 x 60	3	2	14	16,738	19,157	20,069	18,525	17,747	20,069
FWNC-16854-PA	168 x 54	3	2	16	15,802	18,098	18,965	17,499	16,759	18,965
FWNC-16860-PA	168 x 60	3	2	16	17,585	20,003	20,916	19,372	18,593	20,916
FWNC-18054-PA	180 x 54	3	2	16	16,541	18,838	19,704	23,677	17,499	19,704
FWNC-18060-PA	180 x 60	3	2	16	18,432	20,850	21,763	25,946	19,440	21,763
FWNC-19254-PA	192 x 54	3	2	18	17,281	19,578	20,444	24,416	18,239	20,444
FWNC-19260-PA	192 x 60	3	2	18	19,278	21,697	22,610	26,793	20,287	22,610
FWNC-19266-PA	192 x 66	3	4	18	24,464	27,028	27,996	32,434	-	27,996
FWNC-19272-PA	192 x 72	3	4	18	25,827	28,392	29,360	33,797	-	29,360
FWNC-20454-PA	204 x 54	3	2	18	18,752	21,142	22,044	26,177	19,749	22,044
FWNC-20460-PA	204 x 60	3	2	18	20,941	23,458	24,408	28,762	21,992	24,408
FWNC-20466-PA	204 x 66	3	4	18	26,623	29,293	30,300	34,917	-	30,300
FWNC-20472-PA	204 x 72	3	4	18	28,131	30,801	31,808	36,426	-	31,808
FWNC-21654-PA	216 x 54	3	2	20	19,999	22,447	23,370	27,605	21,020	23,370
FWNC-21660-PA	216 x 60	3	2	20	22,354	24,933	25,906	30,365	23,430	25,906
FWNC-21666-PA	216 x 66	3	4	20	28,468	31,203	32,234	36,964	-	32,234
FWNC-21672-PA	216 x 72	3	4	20	30,104	32,839	33,870	38,601	-	33,870
FWNC-22854-PA	228 x 54	3	2	20	20,984	23,456	24,388	28,663	22,016	24,388
FWNC-22860-PA	228 x 60	3	2	20	23,479	26,082	27,063	31,566	24,565	27,063
FWNC-22866-PA	228 x 66	3	4	20	29,946	32,706	33,747	38,522	-	33,747
FWNC-22872-PA	228 x 72	3	4	20	31,689	34,450	35,491	40,266	-	35,491
FWNC-24054-PA	240 x 54	3	2	20	22,028	24,528	25,470	29,794	23,071	25,470
FWNC-24060-PA	240 x 60	3	2	20	24,666	27,298	28,291	32,844	25,764	28,291
FWNC-24066-PA	240 x 66	3	4	20	31,505	34,297	35,350	40,179	-	35,350
FWNC-24072-PA	240 x 72	3	4	20	33,361	36,153	37,206	42,035	-	37,206



# LAMINATE TOP WITH ABS REVERSE FLOW EDGE

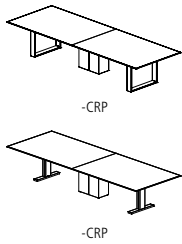

OPTIONS	CODE	PRICE	NOTES
Power and Data Options			See pages 119-129
<b>Remove Center Column for Four Post Base Options:</b> If -P4 base is selected	<b>-4COLP</b>	Deduct \$834	Tables 96" and shorter only
<b>Center Column Base Finish Options:</b> Painted Center Column Base*	Add <b>-CRP</b>	No Charge	To replace existing middle base (Hoop Base and T-Base only)
<b>Polished Chrome Finish Options:</b> Polished Chrome Hoop Base (on 2 base tables) Polished Chrome Hoop Base (on 3 base tables) Polished Chrome T-Base (on 2 base tables) Polished Chrome T-Base (on 3 base tables) T-Base Combination Finish (on 2 base tables) T-Base Combination Finish (on 3 base tables)	Add <b>-PCHP2</b> Add <b>-PCHP3</b> Add <b>-PCTB2</b> Add <b>-PCTB3</b> Add <b>-PCCBF2</b> Add <b>-PCCBF3</b>	\$2,558 \$3,835 \$2,558 \$3,835 \$1,566 \$2,349	*When specifying -CRV or -CRP in conjunction with a Polished Chrome finish on Hoop Base or T-Base tables with 3 bases, use the upcharge code and pricing for 2 base tables (-PCHP2 or -PCTB2).
<b>Multi-Section Tops:</b> 102", 108", 114" and 120" one-piece tops split into two sections	Specify -2	\$761	Note: Power Matrix (center of table location only) cannot be specified when this option is selected
204", 216", 228" or 240" two-piece tops split into four sections	Specify -4	\$1,517	

## EDGE PROFILE

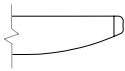

ABS Reverse Flow Edge

## GENERAL INFORMATION

- Tops are 1-1/8"-thick with 2mm ABS edge
- Seating capacity based on 27" per person
- Overall table height 29.5"
- T-Base combination finish includes a Polished Chrome foot and Powder Coat vertical column
- Beam finish will match Metal Finish selection. If no Metal Finish is selected, beams will be Foil.
- If Polished Chrome Finish is specified on the T-Base or Hoop Base, the beams will be Foil. If Polished Chrome Finish is specified on the Four Post Base, the beams will be Clear Anodized.
- Underside of table edge is painted to match ABS color
- Tables with three Hoop or T-Bases will default to the same base style for all three bases. An alternate Center Column Base may also be specified above.
- One wire manager included with the Hoop Base table (regardless of table size). Can be adhered to the leg and will default to the finish of the leg. If additional wire management channels are required, they can be purchased separately at the end of the pricelist.
- Center Wire Chase available on two base tables for more robust wire management needs. See page 128.
- Panel, Rectangle, Expandable Rectangle, Island, Metal T-base, and Center Column bases have a removable access panel

### REQUIRED INFORMATION (ORDER CANNOT BE ENTERED WITHOUT THIS INFORMATION)

See appendix pages vi-vii for surface material options.

- Choose Laminate
- Choose ABS Color
- Choose Metal Finish. Clear Anodized (-CA) not available on T-Base or Hoop Base.
- Choose Paint Finish, if -PP, -PR, -PX, -PN or -CRP bases are selected





# LAMINATE TOP WITH ABS REVERSE FLOW EDGE

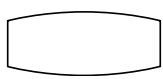

BOAT TOP

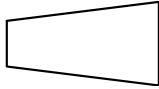

SIGHT LINE TOP

**BASE KEY**

PP	Painted Panel	TB	Metal T-Base
P4	Painted Four Post	HP	Metal Hoop
PR	Painted Rectangle		
PX	Painted Expandable Rectangle		

**BOAT TABLES**

MODEL #	L x W	BASE QTY	TOP SECTIONS	SEATING CAPACITY	-PP	-P4	-PR	-PX	-TB	-HP
FWNB-7240-PA	72 x 32/40	2	1	6	4,939	5,975	5,975	6,366	5,371	-
FWNB-7840-PA	78 x 32/40	2	1	6	5,466	6,575	6,575	6,993	5,928	-
FWNB-8444-PA	84 x 32/44	2	1	8	6,068	7,215	7,215	7,647	6,547	-
FWNB-9044-PA	90 x 32/44	2	1	8	6,601	7,806	7,806	8,262	7,104	-
FWNB-9648-PA	96 x 36/48	2	1	8	7,086	8,292	8,292	8,746	7,589	8,746
FWNB-10248-PA	102 x 36/48	2	1	8	7,726	8,999	8,999	9,479	8,257	9,479
FWNB-10848-PA	108 x 36/48	2	1	10	7,973	9,245	9,245	9,725	8,504	9,725
FWNB-11450-PA	114 x 36/50	2	1	10	9,222	10,621	10,621	11,149	9,806	11,149
FWNB-12050-PA	120 x 36/50	2	1	10	9,503	10,902	10,902	11,430	10,086	11,430
FWNB-13254-PA	132 x 36/54	2	2	10	10,930	12,388	12,388	12,938	11,538	12,938
FWNB-14454-PA	144 x 36/54	2	2	12	12,019	13,535	13,535	14,106	12,651	14,106
FWNB-15654-PA	156 x 36/54	3	2	12	15,062	17,358	17,358	18,225	16,020	18,225
FWNB-16860-PA	168 x 42/60	3	2	14	17,585	20,003	20,003	20,916	18,593	20,916
FWNB-18060-PA	180 x 42/60	3	2	14	18,432	20,850	20,850	21,763	19,440	21,763
FWNB-19272-PA	192 x 54/72	3	4	18	25,827	28,392	28,392	29,360	-	29,360
FWNB-20472-PA	204 x 54/72	3	4	18	28,131	30,801	30,801	31,808	-	31,808
FWNB-21672-PA	216 x 54/72	3	4	20	30,104	32,839	32,839	33,870	-	33,870
FWNB-22872-PA	228 x 54/72	3	4	20	31,689	34,450	34,450	35,491	-	35,491
FWNB-24072-PA	240 x 54/72	3	4	20	33,361	36,153	36,153	37,206	-	37,206

**SIGHT LINE TABLES**

MODEL #	L x W	BASE QTY	TOP SECTIONS	SEATING CAPACITY	-PP	-P4	-PR	-PX	-TB	-HP
FWNA-7254-PA	72 x 36/54	2	1	7	5,992	-	7,111	7,533	6,459	7,533
FWNA-7856-PA	78 x 36/56	2	1	7	7,133	-	8,394	8,869	7,659	8,869
FWNA-8458-PA	84 x 36/58	2	1	9	7,535	-	8,796	9,271	8,061	9,271
FWNA-9060-PA	90 x 36/60	2	1	9	8,368	-	9,695	10,195	8,922	10,195
FWNA-9660-PA	96 x 36/60	2	1	9	8,681	-	10,007	10,508	9,234	10,508
FWNA-10260-PA	102 x 36/60	2	1	9	9,492	-	10,893	11,420	10,076	11,420
FWNA-10860-PA	108 x 36/60	2	1	11	9,823	-	11,222	11,751	10,407	11,751
FWNA-11460-PA	114 x 36/60	2	1	11	10,688	-	12,161	12,716	11,302	12,716
FWNA-12066-PA	120 x 36/66	2	2	11	14,148	-	15,711	16,300	14,800	16,300
FWNA-13268-PA	132 x 36/68	2	3	11	16,014	-	17,643	18,257	16,694	18,257
FWNA-14470-PA	144 x 36/70	2	3	13	18,041	-	19,733	20,372	-	20,372
FWNA-15672-PA	156 x 36/72	3	3	13	22,207	-	24,773	25,740	-	25,740
FWNA-16876-PA	168 x 36/76	3	3	15	23,519	-	26,011	26,951	-	26,951
FWNA-18078-PA	180 x 36/78	3	3	15	25,160	-	27,652	28,592	-	28,592
FWNA-19278-PA	192 x 36/78	3	4	17	26,415	-	28,907	29,847	-	29,847
FWNA-20478-PA	204 x 36/78	3	4	17	28,793	-	31,387	32,365	-	32,365
FWNA-21678-PA	216 x 36/78	3	4	19	30,834	-	33,490	34,492	-	34,492
FWNA-22878-PA	228 x 36/78	3	4	19	32,477	-	35,159	36,171	-	36,171
FWNA-24078-PA	240 x 36/78	3	4	19	34,210	-	36,923	37,946	-	37,946



# LAMINATE TOP WITH ABS REVERSE FLOW EDGE

OPTIONS	CODE	PRICE	NOTES
Power and Data Options			See pages 119-129
<b>Remove Center Column for Four Post Base Options:</b> If -P4 base is selected	<b>-4COLP</b>	Deduct \$834	Tables 96" and shorter only
<b>Center Column Base Finish Options:</b> Painted Center Column Base*	Add <b>-CRP</b>	No Charge	To replace existing middle base (Hoop Base and T-Base only)
<b>Polished Chrome Finish Options:</b> Polished Chrome Four Post Base Polished Chrome Hoop Base (on 2 base tables) Polished Chrome Hoop Base (on 3 base tables) Polished Chrome T-Base (on 2 base tables) Polished Chrome T-Base (on 3 base tables) T-Base Combination Finish (on 2 base tables) T-Base Combination Finish (on 3 base tables)	Add <b>-PCFB</b> Add <b>-PCHP2</b> Add <b>-PCHP3</b> Add <b>-PCTB2</b> Add <b>-PCTB3</b> Add <b>-PCCBF2</b> Add <b>-PCCBF3</b>	\$2,558 \$2,558 \$3,835 \$2,558 \$3,835 \$1,566 \$2,349	*When specifying -CRV or -CRP in conjunction with a Polished Chrome finish on Hoop Base or T-Base tables with 3 bases, use the upcharge code and pricing for 2 base tables (-PCHP2 or -PCTB2).
<b>Multi-Section Tops:</b> 102", 108", 114" and 120" one-piece tops split into two sections	Specify -2	\$761	Note: Power Matrix (center of table location only) cannot be specified when this option is selected

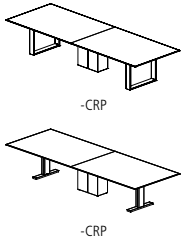

## EDGE PROFILE

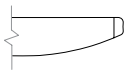

ABS Reverse Flow Edge

## GENERAL INFORMATION

- Tops are 1-1/8" thick with 3/16" deep hardwood edge band
- Seating capacity based on 27" per person
- Overall table height 29.5"
- Four Post Base includes a 12"x24" center column for wire management. Center column may be removed from tables 96" and shorter with options -4COLP or -4COLV above. On tables over 96", the center column is required for support.
- T-Base combination finish includes a Polished Chrome foot and Powder Coat vertical column
- Beam finish will match Metal Finish selection. If no Metal Finish is selected, beams will be Foil.
- If Polished Chrome Finish is specified on the T-Base or Hoop Base, the beams will be Foil. If Polished Chrome Finish is specified on the Four Post Base, the beams will be Clear Anodized.
- Underside of table edge is painted to match ABS color
- Tables with three Hoop or T-Bases will default to the same base style for all three bases. An alternate Center Column Base may also be specified above.
- One wire manager included with the Hoop Base table (regardless of table size). Can be adhered to the leg and will default to the finish of the leg. If additional wire management channels are required, they can be purchased separately at the end of the pricelist.
- Center Wire Chase available on two base tables for more robust wire management needs. See page 128.
- Panel, Rectangle, Expandable Rectangle, Metal T-base, and Center Column bases have a removable access panel

### REQUIRED INFORMATION (ORDER CANNOT BE ENTERED WITHOUT THIS INFORMATION)

See appendix pages vi-vii for surface material options.

- Choose Laminate
- Choose ABS Color
- Choose Metal Finish. Clear Anodized (-CA) not available on T-Base or Hoop Base.
- Choose Paint Finish, if -PP, -P4, -PR, -PX or -CRP bases are selected



# GLASS TOP

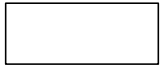

RECTANGLE TOP

### BASE KEY

PP	Painted Panel	TB	Metal T-Base	VP	Veneer Panel
P4	Painted Four Post	HP	Metal Hoop	V4	Veneer Four Post
PR	Painted Rectangle			VR	Veneer Rectangle
PX	Painted Expandable Rectangle			VX	Veneer Expanded Rectangle
PN	Island			VN	Island

### RECTANGLE TABLES

MODEL #	L x W	BASE QTY	SUB-TOP SECTIONS	GLASS SECTIONS	-PP	-P4	-PR	-PX	-PN	-TB	-HP	-VP	-V4	-VR	-VX	-VN
FWNT-7236-G	72 x 36	2	1	1	-	7,491	7,491	7,871	-	6,904	-	-	7,871	7,871	8,274	-
FWNT-7242-G	72 x 42	2	1	1	-	8,609	8,609	9,023	-	7,970	-	-	9,023	9,023	9,461	-
FWNT-7842-G	78 x 42	2	1	1	-	9,527	9,527	9,969	-	8,843	-	-	9,969	9,969	10,438	-
FWNT-8442-G	84 x 42	2	1	1	-	9,846	9,846	10,288	-	9,163	-	-	10,288	10,288	10,757	-
FWNT-8448-G	84 x 48	2	1	1	9,569	10,782	10,782	11,240	-	10,075	11,240	10,068	11,240	11,240	11,725	-
FWNT-9042-G	90 x 42	2	1	1	-	10,694	10,694	11,159	-	9,975	-	-	11,159	11,159	11,652	-
FWNT-9048-G	90 x 48	2	1	1	10,460	11,735	11,735	12,217	-	10,992	12,217	10,985	12,217	12,217	12,727	-
FWNT-9642-G	96 x 42	2	1	1	-	11,031	11,031	11,496	-	10,312	-	-	11,496	11,496	11,989	-
FWNT-9648-G	96 x 48	2	1	1	10,853	12,129	12,129	12,610	-	11,385	12,610	11,378	12,610	12,610	13,120	-
FWNT-10242-G	102 x 42	2	1	2	-	11,998	11,998	12,489	-	11,239	-	-	12,489	12,489	13,010	-
FWNT-10248-G	102 x 48	2	1	2	11,870	13,217	13,217	13,725	-	12,432	13,725	12,424	13,725	13,725	14,264	-
FWNT-10842-G	108 x 42	2	1	2	-	12,354	12,354	12,845	-	11,595	-	-	12,845	12,845	13,366	-
FWNT-10848-G	108 x 48	2	1	2	12,284	13,631	13,631	14,139	-	12,846	14,139	12,839	14,139	14,139	14,678	-
FWNT-10854-G	108 x 54	2	1	2	13,720	15,126	15,126	15,657	16,424	14,306	15,657	14,298	15,657	15,657	16,219	16,975
FWNT-11442-G	114 x 42	2	1	2	-	13,378	13,378	13,894	-	12,579	-	-	13,894	13,894	14,442	-
FWNT-11448-G	114 x 48	2	1	2	13,368	14,785	14,785	15,320	-	13,959	15,320	13,951	15,320	15,320	15,887	-
FWNT-11454-G	114 x 54	2	1	2	14,950	16,431	16,431	16,989	17,797	15,568	16,989	15,559	16,989	16,989	17,581	18,377
FWNT-12042-G	120 x 42	2	1	2	-	13,751	13,751	14,268	-	12,953	-	-	14,268	14,268	14,816	-
FWNT-12048-G	120 x 48	2	1	2	13,804	15,221	15,221	15,756	-	14,395	15,756	14,387	15,756	15,756	16,323	-
FWNT-12054-G	120 x 54	2	1	2	15,458	16,938	16,938	17,497	18,305	16,075	17,497	16,067	17,497	17,497	18,089	18,884
FWNT-13248-G	132 x 48	2	2	3	15,289	16,765	16,765	17,322	-	15,905	17,322	15,896	17,322	17,322	17,913	-
FWNT-13254-G	132 x 54	2	2	3	17,160	18,702	18,702	19,284	20,125	17,803	19,284	17,794	19,284	19,284	19,901	20,729
FWNT-14448-G	144 x 48	2	2	3	16,846	18,382	18,382	18,961	-	17,487	18,961	17,478	18,961	18,961	19,575	-
FWNT-14454-G	144 x 54	2	2	3	18,947	20,551	20,551	21,155	22,031	19,616	21,155	19,607	21,155	21,155	21,797	22,659
FWNT-14460-G	144 x 60	2	2	3	21,380	23,069	23,069	23,706	24,628	22,084	23,706	22,075	23,706	23,706	24,382	25,289
FWNT-15648-G	156 x 48	3	2	3	20,266	-	22,593	23,471	-	21,237	23,471	21,223	-	23,471	24,402	-
FWNT-15654-G	156 x 54	3	2	3	22,647	25,077	25,077	25,994	24,443	23,661	25,994	23,647	25,994	25,994	26,966	25,077
FWNT-15660-G	156 x 60	3	2	3	25,411	27,970	27,970	28,936	27,302	26,478	28,936	26,464	28,936	28,936	29,960	27,970
FWNT-16854-G	168 x 54	3	2	3	23,846	26,276	26,276	27,193	25,642	24,859	27,193	24,846	27,193	27,193	28,165	26,276
FWNT-16860-G	168 x 60	3	2	3	26,793	29,352	29,352	30,318	28,684	27,860	30,318	27,846	30,318	30,318	31,342	29,352
FWNT-18054-G	180 x 54	3	2	3	25,043	27,474	27,474	28,390	32,594	26,057	28,390	26,043	28,390	28,390	29,363	33,863
FWNT-18060-G	180 x 60	3	2	3	28,175	30,734	30,734	31,700	36,127	29,242	31,700	29,228	31,700	31,700	32,724	37,463
FWNT-19254-G	192 x 54	3	2	4	26,242	28,673	28,673	29,589	33,793	27,256	29,589	27,242	29,589	29,589	30,561	35,061
FWNT-19260-G	192 x 60	3	2	4	29,558	32,117	32,117	33,083	37,510	30,625	33,083	30,611	33,083	33,083	34,107	38,846
FWNT-19266-G	192 x 66	3	4	4	38,196	40,910	40,910	41,934	46,630	-	41,934	39,313	41,934	41,934	43,020	48,047
FWNT-19272-G	192 x 72	3	4	4	40,602	43,316	43,316	44,340	49,036	-	44,340	41,719	44,340	44,340	45,426	50,453
FWNT-20454-G	204 x 54	3	2	4	28,555	31,084	31,084	32,038	36,412	29,610	32,038	29,596	32,038	32,038	33,050	37,732
FWNT-20460-G	204 x 60	3	2	4	32,195	34,859	34,859	35,864	40,471	33,307	35,864	33,291	35,864	35,864	36,929	41,861
FWNT-20466-G	204 x 66	3	4	4	41,670	44,495	44,495	45,561	50,447	-	45,561	42,832	45,561	45,561	46,691	51,921
FWNT-20472-G	204 x 72	3	4	4	44,329	47,154	47,154	48,220	53,106	-	48,220	45,491	48,220	48,220	49,350	54,580
FWNT-21654-G	216 x 54	3	2	4	30,530	33,121	33,121	34,098	38,579	31,611	34,098	31,596	34,098	34,098	35,134	39,931
FWNT-21660-G	216 x 60	3	2	4	34,454	37,183	37,183	38,212	42,931	35,592	38,212	35,577	38,212	38,212	39,304	44,355
FWNT-21666-G	216 x 66	3	4	4	44,656	47,550	47,550	48,641	53,647	-	48,641	45,847	48,641	48,641	49,799	55,157
FWNT-21672-G	216 x 72	3	4	4	47,541	50,435	50,435	51,526	56,532	-	51,526	48,732	51,526	51,526	52,684	58,042
FWNT-22854-G	228 x 54	3	2	4	32,110	34,726	34,726	35,712	40,236	33,202	35,712	33,187	35,712	35,712	36,759	41,601
FWNT-22860-G	228 x 60	3	2	4	36,271	39,025	39,025	40,064	44,829	37,420	40,064	37,404	40,064	40,064	41,166	46,266
FWNT-22866-G	228 x 66	3	4	4	47,070	49,991	49,991	51,093	56,146	-	51,093	48,272	51,093	51,093	52,262	57,671
FWNT-22872-G	228 x 72	3	4	4	50,144	53,065	53,065	54,167	59,220	-	54,167	51,346	54,167	54,167	55,336	60,745
FWNT-24054-G	240 x 54	3	2	4	33,778	36,423	36,423	37,420	41,995	34,881	37,420	34,866	37,420	37,420	38,478	43,376
FWNT-24060-G	240 x 60	3	2	4	38,186	40,971	40,971	42,022	46,840	39,348	42,022	39,332	42,022	42,022	43,136	48,294
FWNT-24066-G	240 x 66	3	4	4	49,614	52,569	52,569	53,683	58,793	-	53,683	50,830	53,683	53,683	54,865	60,336
FWNT-24072-G	240 x 72	3	4	4	52,886	55,841	55,841	56,955	62,065	-	56,955	54,102	56,955	56,955	58,137	63,608



# GLASS TOP

OPTIONS	CODE	PRICE	NOTES
Power and Data Options			See pages 119-129
<b>Satin Glass Options:</b>			
72"-96" Tables	Add <b>-FSG</b>	\$632	
102"-132" Tables	Add <b>-FSG</b>	\$842	
144"-180" Tables	Add <b>-FSG</b>	\$1,055	
192"-228" Tables	Add <b>-FSG</b>	\$1,355	
240" Tables	Add <b>-FSG</b>	\$1,555	
<b>Remove Center Column for Four Post Base Options:</b>			
If -P4 base is selected	<b>-4COLP</b>	Deduct \$834	Tables 96" and shorter only
If -V4 base is selected	<b>-4COLV</b>	Deduct \$1,286	Tables 96" and shorter only
<b>Center Column Base Finish Options:</b>			
Painted Center Column Base*	Add <b>-CRP</b>	No Charge	To replace existing middle base (Hoop Base and T-Base only)
Veneer Center Column Base*	Add <b>-CRV</b>	No Charge	To replace existing middle base (Hoop Base and T-Base only)
<b>Polished Chrome Finish Options:</b>			
Polished Chrome Four Post Base	Add <b>-PCFB</b>	\$2,558	*When specifying -CRV or -CRP in conjunction with a Polished Chrome finish on Hoop Base or T-Base tables with 3 bases, use the upcharge code and pricing for 2 base tables (-PCHP2 or -PCTB2).
Polished Chrome Hoop Base (on 2 base tables)	Add <b>-PCHP2</b>	\$2,558	
Polished Chrome Hoop Base (on 3 base tables)	Add <b>-PCHP3</b>	\$3,835	
Polished Chrome T-Base (on 2 base tables)	Add <b>-PCTB2</b>	\$2,558	
Polished Chrome T-Base (on 3 base tables)	Add <b>-PCTB3</b>	\$3,835	
T-Base Combination Finish (on 2 base tables)	Add <b>-PCCBF2</b>	\$1,566	
T-Base Combination Finish (on 3 base tables)	Add <b>-PCCBF3</b>	\$2,349	
<b>Multi-Section Tops:</b>			
102", 108", 114" and 120" one-piece tops split into two sections	Specify -2	\$761	Note: Power Matrix (center of table location only) cannot be specified when this option is selected
204", 216", 228" or 240" two-piece tops split into four sections	Specify -4	\$1,517	

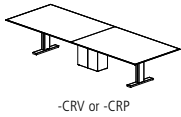
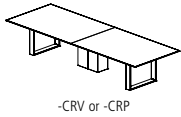

## EDGE PROFILE



Glass Edge

## GENERAL INFORMATION

- Tops are 1-1/8" thick sub-top with 1/4" thick back-painted low iron glass
- Glass sections noted are for tables without power units. When power units are specified in the table, the glass sections are determined by the size of the power unit, quantity and location.
- Unless otherwise specified, the sub-top finish will match the base finish (specification required when base is polished chrome)
- Seating capacity based on 27" per person
- Overall table height 29.5"
- Four Post Base includes a 12"x24" center column for wire management. Center column may be removed from tables 96" and shorter with options -4COLP or -4COLV above. On tables over 96", the center column is required for support.
- T-Base combination finish includes a Polished Chrome foot and Powder Coat vertical column
- Due to the color variation inherent with the natural etching process, larger size tables longer than 180" or wider than 60" may have glass color variation
- Beam finish will match Metal Finish selection. If no Metal Finish is selected, beams will be Foil.
- If Polished Chrome Finish is specified on the T-Base or Hoop Base, the beams will be Foil. If Polished Chrome Finish is specified on the Four Post Base, the beams will be Clear Anodized.
- Tables with three Hoop or T-Bases will default to the same base style for all three bases. An alternate Center Column Base may also be specified above.
- One wire manager included with the Hoop Base table (regardless of table size). Can be adhered to the leg and will default to the finish of the leg. If additional wire management channels are required, they can be purchased separately at the end of the pricelist.
- Center Wire Chase available on two base tables for more robust wire management needs. See page 128.
- Panel, Rectangle, Expandable Rectangle, Island, Metal T-base, and Center Column bases have a removable access panel

### REQUIRED INFORMATION (ORDER CANNOT BE ENTERED WITHOUT THIS INFORMATION)

See appendix pages vi-vii for surface material options.

- Choose Glass Finish (Satin Glass upcharges apply, see options above)
- Choose Sub-Top Finish:
  - Paint Finish, or
  - Veneer Finish
- Choose Metal Finish. Clear Anodized (-CA) not available on T-Base or Hoop Base.
- Choose Veneer Finish, if -VP, -V4, -VR, -VX, -VN or -CRV base is selected
- Choose Paint Finish, if -PP, -P4, -PR, -PX, -PN or -CRP bases are selected



# GLASS TOP

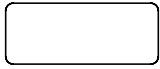

RADIUS RECTANGLE TOP

**BASE KEY**

PP	Painted Panel	TB	Metal T-Base	VP	Veneer Panel
PR	Painted Rectangle	HP	Metal Hoop	VR	Veneer Rectangle
PX	Painted Expandable Rectangle			VX	Veneer Expanded Rectangle
PN	Island			VN	Island

**RADIUS RECTANGLE TABLES**

MODEL #	L x W	BASE QTY	SUB-TOP SECTIONS	GLASS SECTIONS	-PP	-PR	-PX	-PN	-TB	-HP	-VP	-VR	-VX	-VN
FWNC-7236-G	72 x 36	2	1	1	-	7,491	7,871	-	6,904	-	-	7,871	8,274	-
FWNC-7242-G	72 x 42	2	1	1	-	8,609	9,023	-	7,970	-	-	9,023	9,461	-
FWNC-7842-G	78 x 42	2	1	1	-	9,527	9,969	-	8,843	-	-	9,969	10,438	-
FWNC-8442-G	84 x 42	2	1	1	-	9,846	10,288	-	9,163	-	-	10,288	10,757	-
FWNC-8448-G	84 x 48	2	1	1	9,569	10,782	11,240	-	10,075	11,240	10,068	11,240	11,725	-
FWNC-9042-G	90 x 42	2	1	1	-	10,694	11,159	-	9,975	-	-	11,159	11,652	-
FWNC-9048-G	90 x 48	2	1	1	10,460	11,735	12,217	-	10,992	12,217	10,985	12,217	12,727	-
FWNC-9642-G	96 x 42	2	1	1	-	11,031	11,496	-	10,312	-	-	11,496	11,989	-
FWNC-9648-G	96 x 48	2	1	1	10,853	12,129	12,610	-	11,385	12,610	11,378	12,610	13,120	-
FWNC-10242-G	102 x 42	2	1	2	-	11,998	12,489	-	11,239	-	-	12,489	13,010	-
FWNC-10248-G	102 x 48	2	1	2	11,870	13,217	13,725	-	12,432	13,725	12,424	13,725	14,264	-
FWNC-10842-G	108 x 42	2	1	2	-	12,354	12,845	-	11,595	-	-	12,845	13,366	-
FWNC-10848-G	108 x 48	2	1	2	12,284	13,631	14,139	-	12,846	14,139	12,839	14,139	14,678	-
FWNC-10854-G	108 x 54	2	1	2	13,720	15,126	15,657	16,424	14,306	15,657	14,298	15,657	16,219	16,975
FWNC-11442-G	114 x 42	2	1	2	-	13,378	13,894	-	12,579	-	-	13,894	14,442	-
FWNC-11448-G	114 x 48	2	1	2	13,368	14,785	15,320	-	13,959	15,320	13,951	15,320	15,887	-
FWNC-11454-G	114 x 54	2	1	2	14,950	16,431	16,989	17,797	15,568	16,989	15,559	16,989	17,581	18,377
FWNC-12042-G	120 x 42	2	1	2	-	13,751	14,268	-	12,953	-	-	14,268	14,816	-
FWNC-12048-G	120 x 48	2	1	2	13,804	15,221	15,756	-	14,395	15,756	14,387	15,756	16,323	-
FWNC-12054-G	120 x 54	2	1	2	15,458	16,938	17,497	18,305	16,075	17,497	16,067	17,497	18,089	18,884
FWNC-13248-G	132 x 48	2	2	3	15,289	16,765	17,322	-	15,905	17,322	15,896	17,322	17,913	-
FWNC-13254-G	132 x 54	2	2	3	17,160	18,702	19,284	20,125	17,803	19,284	17,794	19,284	19,901	20,729
FWNC-14448-G	144 x 48	2	2	3	16,846	18,382	18,961	-	17,487	18,961	17,478	18,961	19,575	-
FWNC-14454-G	144 x 54	2	2	3	18,947	20,551	21,155	22,031	19,616	21,155	19,607	21,155	21,797	22,659
FWNC-14460-G	144 x 60	2	2	3	21,380	23,069	23,706	24,628	22,084	23,706	22,075	23,706	24,382	25,289
FWNC-15648-G	156 x 48	3	2	3	20,266	22,593	23,471	-	21,237	23,471	21,223	23,471	24,402	-
FWNC-15654-G	156 x 54	3	2	3	22,647	25,077	25,994	24,443	23,661	25,994	23,647	25,994	26,966	25,077
FWNC-15660-G	156 x 60	3	2	3	25,411	27,970	28,936	27,302	26,478	28,936	26,464	28,936	29,960	27,970
FWNC-16854-G	168 x 54	3	2	3	23,846	26,276	27,193	25,642	24,859	27,193	24,846	27,193	28,165	26,276
FWNC-16860-G	168 x 60	3	2	3	26,793	29,352	30,318	28,684	27,860	30,318	27,846	30,318	31,342	29,352
FWNC-18054-G	180 x 54	3	2	3	25,043	27,474	28,390	32,594	26,057	28,390	26,043	28,390	29,363	33,863
FWNC-18060-G	180 x 60	3	2	3	28,175	30,734	31,700	36,127	29,242	31,700	29,228	31,700	32,724	37,463
FWNC-19254-G	192 x 54	3	2	4	26,242	28,673	29,589	33,793	27,256	29,589	27,242	29,589	30,561	35,061
FWNC-19260-G	192 x 60	3	2	4	29,558	32,117	33,083	37,510	30,625	33,083	30,611	33,083	34,107	38,846
FWNC-19266-G	192 x 66	3	4	4	38,196	40,910	41,934	46,630	-	41,934	39,313	41,934	43,020	48,047
FWNC-19272-G	192 x 72	3	4	4	40,602	43,316	44,340	49,036	-	44,340	41,719	44,340	45,426	50,453
FWNC-20454-G	204 x 54	3	2	4	28,555	31,084	32,038	36,412	29,610	32,038	29,596	32,038	33,050	37,732
FWNC-20460-G	204 x 60	3	2	4	32,195	34,859	35,864	40,471	33,307	35,864	33,291	35,864	36,929	41,861
FWNC-20466-G	204 x 66	3	4	4	41,670	44,495	45,561	50,447	-	45,561	42,832	45,561	46,691	51,921
FWNC-20472-G	204 x 72	3	4	4	44,329	47,154	48,220	53,106	-	48,220	45,491	48,220	49,350	54,580
FWNC-21654-G	216 x 54	3	2	4	30,530	33,121	34,098	38,579	31,611	34,098	31,596	34,098	35,134	39,931
FWNC-21660-G	216 x 60	3	2	4	34,454	37,183	38,212	42,931	35,592	38,212	35,577	38,212	39,304	44,355
FWNC-21666-G	216 x 66	3	4	4	44,656	47,550	48,641	53,647	-	48,641	45,847	48,641	49,799	55,157
FWNC-21672-G	216 x 72	3	4	4	47,541	50,435	51,526	56,532	-	51,526	48,732	51,526	52,684	58,042
FWNC-22854-G	228 x 54	3	2	4	32,110	34,726	35,712	40,236	33,202	35,712	33,187	35,712	36,759	41,601
FWNC-22860-G	228 x 60	3	2	4	36,271	39,025	40,064	44,829	37,420	40,064	37,404	40,064	41,166	46,266
FWNC-22866-G	228 x 66	3	4	4	47,070	49,991	51,093	56,146	-	51,093	48,272	51,093	52,262	57,671
FWNC-22872-G	228 x 72	3	4	4	50,144	53,065	54,167	59,220	-	54,167	51,346	54,167	55,336	60,745
FWNC-24054-G	240 x 54	3	2	4	33,778	36,423	37,420	41,995	34,881	37,420	34,866	37,420	38,478	43,376
FWNC-24060-G	240 x 60	3	2	4	38,186	40,971	42,022	46,840	39,348	42,022	39,332	42,022	43,136	48,294
FWNC-24066-G	240 x 66	3	4	4	49,614	52,569	53,683	58,793	-	53,683	50,830	53,683	54,865	60,336
FWNC-24072-G	240 x 72	3	4	4	52,886	55,841	56,955	62,065	-	56,955	54,102	56,955	58,137	63,608



# GLASS TOP

OPTIONS	CODE	PRICE	NOTES
Power and Data Options			See pages 119-129
<b>Satin Glass Options:</b>			
72"-96" Tables	Add <b>-FSG</b>	\$632	
102"-132" Tables	Add <b>-FSG</b>	\$842	
144"-180" Tables	Add <b>-FSG</b>	\$1,055	
192"-228" Tables	Add <b>-FSG</b>	\$1,355	
240" Tables	Add <b>-FSG</b>	\$1,555	
<b>Remove Center Column for Four Post Base Options:</b>			
If -P4 base is selected	<b>-4COLP</b>	Deduct \$834	Tables 96" and shorter only
If -V4 base is selected	<b>-4COLV</b>	Deduct \$1,286	Tables 96" and shorter only
<b>Center Column Base Finish Options:</b>			
Painted Center Column Base*	Add <b>-CRP</b>	No Charge	To replace existing middle base (Hoop Base and T-Base only)
Veneer Center Column Base*	Add <b>-CRV</b>	No Charge	To replace existing middle base (Hoop Base and T-Base only)
<b>Polished Chrome Finish Options:</b>			
Polished Chrome Four Post Base	Add <b>-PCFB</b>	\$2,558	*When specifying -CRV or -CRP in conjunction with a Polished Chrome finish on Hoop Base or T-Base tables with 3 bases, use the upcharge code and pricing for 2 base tables (-PCHP2 or -PCTB2).
Polished Chrome Hoop Base (on 2 base tables)	Add <b>-PCHP2</b>	\$2,558	
Polished Chrome Hoop Base (on 3 base tables)	Add <b>-PCHP3</b>	\$3,835	
Polished Chrome T-Base (on 2 base tables)	Add <b>-PCTB2</b>	\$2,558	
Polished Chrome T-Base (on 3 base tables)	Add <b>-PCTB3</b>	\$3,835	
T-Base Combination Finish (on 2 base tables)	Add <b>-PCCBF2</b>	\$1,566	
T-Base Combination Finish (on 3 base tables)	Add <b>-PCCBF3</b>	\$2,349	
<b>Multi-Section Tops:</b>			
102", 108", 114" and 120" one-piece tops split into two sections	Specify -2	\$761	Note: Power Matrix (center of table location only) cannot be specified when this option is selected
204", 216", 228" or 240" two-piece tops split into four sections	Specify -4	\$1,517	

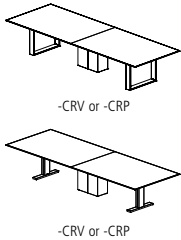

## EDGE PROFILE

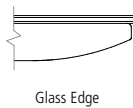

## GENERAL INFORMATION

- Tops are 1-1/8" thick sub-top with 1/4" thick back-painted low iron glass
- Glass sections noted are for tables without power units. When power units are specified in the table, the glass sections are determined by the size of the power unit, quantity and location.
- Unless otherwise specified, the sub-top finish will match the base finish (specification required when base is polished chrome)
- Seating capacity based on 27" per person
- Overall table height 29.5"
- T-Base combination finish includes a Polished Chrome foot and Powder Coat vertical column
- Due to the color variation inherent with the natural etching process, larger size tables longer than 180" or wider than 60" may have glass color variation
- Beam finish will match Metal Finish selection. If no Metal Finish is selected, beams will be Foil.
- If Polished Chrome Finish is specified on the T-Base or Hoop Base, the beams will be Foil. If Polished Chrome Finish is specified on the Four Post Base, the beams will be Clear Anodized.
- Tables with three Hoop or T-Bases will default to the same base style for all three bases. An alternate Center Column Base may also be specified above.
- One wire manager included with the Hoop Base table (regardless of table size). Can be adhered to the leg and will default to the finish of the leg. If additional wire management channels are required, they can be purchased separately at the end of the pricelist.
- Center Wire Chase available on two base tables for more robust wire management needs. See page 128.
- Panel, Rectangle, Expandable Rectangle, Island, Metal T-base, and Center Column bases have a removable access panel

### REQUIRED INFORMATION (ORDER CANNOT BE ENTERED WITHOUT THIS INFORMATION)

See appendix pages vi-vii for surface material options.

- Choose Glass Finish (Satin Glass upcharges apply, see options above)
- Choose Sub-Top Finish:
  - Paint Finish, or
  - Veneer Finish
- Choose Metal Finish. Clear Anodized (-CA) not available on T-Base or Hoop Base.
- Choose Veneer Finish, if -VP, -VR, -VX, -VN or -CRV base is selected
- Choose Paint Finish, if -PP, -PR, -PX, -PN or -CRP bases are selected



# GLASS TOP

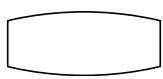

BOAT TOP

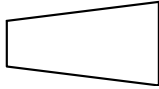

SIGHT LINE TOP

### BASE KEY

PP	Painted Panel	TB	Metal T-Base	VP	Veneer Panel
P4	Painted Four Post	HP	Metal Hoop	V4	Veneer Four Post
PR	Painted Rectangle			VR	Veneer Rectangle
PX	Painted Expandable Rectangle			VX	Veneer Expanded Rectangle

### BOAT TABLES

MODEL #	L x W	BASE QTY	SUB-TOP SECTIONS	GLASS SECTIONS	-PP	-P4	-PR	-PX	-TB	-HP	-VP	-V4	-VR	-VX
FWNB-7240-G	72 x 32/40	2	1	1	7,359	8,455	8,455	8,869	7,816	-	7,810	8,869	8,869	9,307
FWNB-7840-G	78 x 32/40	2	1	1	8,175	9,348	9,348	9,790	8,664	-	8,658	9,790	9,790	10,259
FWNB-8444-G	84 x 32/44	2	1	1	9,172	10,385	10,385	10,843	9,678	-	9,671	10,843	10,843	11,328
FWNB-9044-G	90 x 32/44	2	1	1	10,012	11,287	11,287	11,769	10,544	-	10,537	11,769	11,769	12,279
FWNB-9648-G	96 x 36/48	2	1	1	10,853	12,129	12,129	12,610	11,385	12,610	11,378	12,610	12,610	13,120
FWNB-10248-G	102 x 36/48	2	1	2	11,870	13,217	13,217	13,725	12,432	13,725	12,424	13,725	13,725	14,264
FWNB-10848-G	108 x 36/48	2	1	2	12,284	13,631	13,631	14,139	12,846	14,139	12,839	14,139	14,139	14,678
FWNB-11450-G	114 x 36/50	2	1	2	14,291	15,772	15,772	16,330	14,909	16,330	14,900	16,330	16,330	16,922
FWNB-12050-G	120 x 36/50	2	1	2	14,764	16,244	16,244	16,803	15,381	16,803	15,373	16,803	16,803	17,395
FWNB-13254-G	132 x 36/54	2	2	3	17,160	18,702	18,702	19,284	17,803	19,284	17,794	19,284	19,284	19,901
FWNB-14454-G	144 x 36/54	2	2	3	18,947	20,551	20,551	21,155	19,616	21,155	19,607	21,155	21,155	21,797
FWNB-15654-G	156 x 36/54	3	2	3	22,647	25,077	25,077	25,994	23,661	25,994	23,647	25,994	25,994	26,966
FWNB-16860-G	168 x 42/60	3	2	3	26,793	29,352	29,352	30,318	27,860	30,318	27,846	30,318	30,318	31,342
FWNB-18060-G	180 x 42/60	3	2	4	28,175	30,734	30,734	31,700	29,242	31,700	29,228	31,700	31,700	32,724
FWNB-19272-G	192 x 54/72	3	4	4	40,602	43,316	43,316	44,340	-	44,340	41,719	44,340	44,340	45,426
FWNB-20472-G	204 x 54/72	3	4	4	44,329	47,154	47,154	48,220	-	48,220	45,491	48,220	48,220	49,350
FWNB-21672-G	216 x 54/72	3	4	4	47,541	50,435	50,435	51,526	-	51,526	48,732	51,526	51,526	52,684
FWNB-22872-G	228 x 54/72	3	4	4	50,144	53,065	53,065	54,167	-	54,167	51,346	54,167	54,167	55,336
FWNB-24072-G	240 x 54/72	3	4	4	52,886	55,841	55,841	56,955	-	56,955	54,102	56,955	56,955	58,137

### SIGHT LINE TABLES

MODEL #	L x W	BASE QTY	SUB-TOP SECTIONS	GLASS SECTIONS	-PP	-P4	-PR	-PX	-TB	-HP	-VP	-V4	-VR	-VX
FWNA-7254-G	72 x 36/54	2	1	1	9,116	-	10,300	10,747	9,610	10,747	9,603	-	10,747	11,221
FWNA-7856-G	78 x 36/56	2	1	1	10,929	-	12,263	12,766	11,485	12,766	11,477	-	12,766	13,299
FWNA-8458-G	84 x 36/58	2	1	1	11,620	-	12,954	13,457	12,177	13,457	12,169	-	13,457	13,991
FWNA-9060-G	90 x 36/60	2	1	1	12,984	-	14,388	14,917	13,570	14,917	13,562	-	14,917	15,478
FWNA-9660-G	96 x 36/60	2	1	1	13,516	-	14,919	15,449	14,101	15,449	14,093	-	15,449	16,010
FWNA-10260-G	102 x 36/60	2	1	2	14,826	-	16,308	16,866	15,444	16,866	15,436	-	16,866	17,459
FWNA-10860-G	108 x 36/60	2	1	2	15,387	-	16,868	17,427	16,005	17,427	15,997	-	17,427	18,020
FWNA-11460-G	114 x 36/60	2	1	2	16,786	-	18,345	18,933	17,436	18,933	17,427	-	18,933	19,557
FWNA-12066-G	120 x 36/66	2	2	2	22,592	-	24,246	24,869	23,282	24,869	23,272	-	24,869	25,531
FWNA-13268-G	132 x 36/68	2	3	3	25,725	-	27,448	28,098	26,444	28,098	26,434	-	28,098	28,787
FWNA-14470-G	144 x 36/70	2	3	3	29,132	-	30,923	31,599	-	31,599	29,869	-	31,599	32,316
FWNA-15672-G	156 x 36/72	3	3	3	34,606	-	37,321	38,345	-	38,345	35,723	-	38,345	39,431
FWNA-16876-G	168 x 36/76	3	3	3	36,922	-	39,559	40,554	-	40,554	38,007	-	40,554	41,609
FWNA-18078-G	180 x 36/78	3	3	3	39,692	-	42,329	43,324	-	43,324	40,777	-	43,324	44,378
FWNA-19278-G	192 x 36/78	3	4	4	41,778	-	44,415	45,410	-	45,410	42,863	-	45,410	46,465
FWNA-20478-G	204 x 36/78	3	4	4	45,647	-	48,392	49,427	-	49,427	46,776	-	49,427	50,525
FWNA-21678-G	216 x 36/78	3	4	4	48,986	-	51,797	52,857	-	52,857	50,142	-	52,857	53,982
FWNA-22878-G	228 x 36/78	3	4	4	51,697	-	54,535	55,606	-	55,606	52,865	-	55,606	56,741
FWNA-24078-G	240 x 36/78	3	4	4	54,555	-	57,425	58,508	-	58,508	55,736	-	58,508	59,656



# GLASS TOP

OPTIONS	CODE	PRICE	NOTES
Power and Data Options			See pages 119-129
<b>Satin Glass Options:</b>			
72"-96" Tables	Add <b>-FSG</b>	\$632	
102"-132" Tables	Add <b>-FSG</b>	\$842	
144"-180" Tables	Add <b>-FSG</b>	\$1,055	
192"-228" Tables	Add <b>-FSG</b>	\$1,355	
240" Tables	Add <b>-FSG</b>	\$1,555	
<b>Remove Center Column for Four Post Base Options:</b>			
If -P4 base is selected	<b>-4COLP</b>	Deduct \$834	Tables 96" and shorter only
If -V4 base is selected	<b>-4COLV</b>	Deduct \$1,286	Tables 96" and shorter only
<b>Center Column Base Finish Options:</b>			
Painted Center Column Base*	Add <b>-CRP</b>	No Charge	To replace existing middle base (Hoop Base and T-Base only)
Veneer Center Column Base*	Add <b>-CRV</b>	No Charge	To replace existing middle base (Hoop Base and T-Base only)
<b>Polished Chrome Finish Options:</b>			
Polished Chrome Four Post Base	Add <b>-PCFB</b>	\$2,558	*When specifying -CRV or -CRP in conjunction with a Polished Chrome finish on Hoop Base or T-Base tables with 3 bases, use the upcharge code and pricing for 2 base tables (-PCHP2 or -PCTB2).
Polished Chrome Hoop Base (on 2 base tables)	Add <b>-PCHP2</b>	\$2,558	
Polished Chrome Hoop Base (on 3 base tables)	Add <b>-PCHP3</b>	\$3,835	
Polished Chrome T-Base (on 2 base tables)	Add <b>-PCTB2</b>	\$2,558	
Polished Chrome T-Base (on 3 base tables)	Add <b>-PCTB3</b>	\$3,835	
T-Base Combination Finish (on 2 base tables)	Add <b>-PCCBF2</b>	\$1,566	
T-Base Combination Finish (on 3 base tables)	Add <b>-PCCBF3</b>	\$2,349	
<b>Multi-Section Tops:</b>			
102", 108", 114" and 120" one-piece tops split into two sections	Specify -2	\$761	Note: Power Matrix (center of table location only) cannot be specified when this option is selected

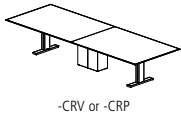
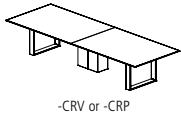

## EDGE PROFILE



Glass Edge

## GENERAL INFORMATION

- Tops are 1-1/8" -thick sub-top with 1/4" -thick back-painted low iron glass
- Glass sections noted are for tables without power units. When power units are specified in the table, the glass sections are determined by the size of the power unit, quantity and location.
- Unless otherwise specified, the sub-top finish will match the base finish (specification required when base is polished chrome)
- Seating capacity based on 27" per person
- Overall table height 29.5"
- Four Post Base includes a 12"x24" center column for wire management. Center column may be removed from tables 96" and shorter with options -4COLP or -4COLV above. On tables over 96", the center column is required for support.
- T-Base combination finish includes a Polished Chrome foot and Powder Coat vertical column
- Due to the color variation inherent with the natural etching process, larger size tables longer than 180" or wider than 60" may have glass color variation
- Beam finish will match Metal Finish selection. If no Metal Finish is selected, beams will be Foil.
- If Polished Chrome Finish is specified on the T-Base or Hoop Base, the beams will be Foil. If Polished Chrome Finish is specified on the Four Post Base, the beams will be Clear Anodized.
- Tables with three Hoop or T-Bases will default to the same base style for all three bases. An alternate Center Column Base may also be specified above.
- One wire manager included with the Hoop Base table (regardless of table size). Can be adhered to the leg and will default to the finish of the leg. If additional wire management channels are required, they can be purchased separately at the end of the pricelist.
- Center Wire Chase available on two base tables for more robust wire management needs. See page 128.
- Panel, Rectangle, Expandable Rectangle, Metal T-base, and Center Column bases have a removable access panel

### REQUIRED INFORMATION (ORDER CANNOT BE ENTERED WITHOUT THIS INFORMATION)

See appendix pages vi-vii for surface material options.

- Choose Glass Finish (Satin Glass upcharges apply, see options above)
- Choose Sub-Top Finish:
  - Paint Finish, or
  - Veneer Finish
- Choose Metal Finish. Clear Anodized (-CA) not available on T-Base or Hoop Base.
- Choose Veneer Finish, if -VP, -V4, -VR, -VX, -VN or -CRV base is selected
- Choose Paint Finish, if -PP, -P4, -PR, -PX, -PN or -CRP bases are selected





# STONE / QUARTZ TOP

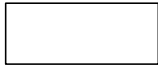

RECTANGLE TOP

**BASE KEY**

PR	Painted Rectangle	HP	Metal Hoop	VR	Veneer Rectangle
PC	Painted Column			VC	Veneer Column

**RECTANGLE TABLES**

MODEL #	L x W	BASE QTY	SUB-TOP SECTIONS	STONE SECTIONS	SEATING CAPACITY	-PR	-PC	-HP	-VR	-VC
FWNT-8442-S	84 x 42	2	1	1	8	13,949	14,798	-	14,798	15,698
FWNT-8448-S	84 x 48	2	1	1	8	15,111	15,990	15,990	15,990	16,921
FWNT-9648-S	96 x 48	2	1	2	8	16,847	17,770	17,770	17,770	18,749
FWNT-10848-S	108 x 48	2	1	2	10	18,784	19,759	19,759	19,759	20,794
FWNT-12048-S	120 x 48	2	1	2	10	20,829	21,856	21,856	21,856	22,944
FWNT-12054-S	120 x 54	2	1	2	12	22,941	24,014	24,014	24,014	25,151
FWNT-14448-S	144 x 48	3	2	2	12	28,726	30,394	30,394	30,394	32,162
FWNT-14454-S	144 x 54	3	2	2	14	31,546	33,288	33,288	33,288	35,135
FWNT-14460-S	144 x 60	3	2	3	14	34,848	36,682	36,682	36,682	38,629
FWNT-15648-S	156 x 48	3	2	3	14	32,149	33,835	33,835	33,835	35,622
FWNT-15654-S	156 x 54	3	2	3	14	35,267	37,028	37,028	37,028	38,894
FWNT-15660-S	156 x 60	3	2	3	14	38,921	40,776	40,776	40,776	42,742
FWNT-16854-S	168 x 54	3	2	3	16	36,770	38,531	38,531	38,531	40,397
FWNT-16860-S	168 x 60	3	2	4	16	40,641	42,496	42,496	42,496	44,462
FWNT-18054-S	180 x 54	3	2	3	16	38,274	40,032	40,032	40,032	41,901
FWNT-18060-S	180 x 60	3	2	4	16	42,361	44,216	44,216	44,216	46,182
FWNT-19254-S	192 x 54	3	2	3	18	39,777	41,536	41,536	41,536	43,402
FWNT-19260-S	192 x 60	3	2	4	18	44,082	45,936	45,936	45,936	47,903
FWNT-20454-S	204 x 54	3	2	3	18	42,955	44,786	44,786	44,786	46,729
FWNT-20460-S	204 x 60	3	2	4	18	47,661	49,590	49,590	49,590	51,635
FWNT-21654-S	216 x 54	3	2	3	20	45,606	47,482	47,482	47,482	49,471
FWNT-21660-S	216 x 60	3	2	4	20	50,658	52,633	52,633	52,633	54,730
FWNT-22854-S	228 x 54	4	2	4	20	52,057	54,582	54,582	54,582	57,261
FWNT-22860-S	228 x 60	4	2	5	20	57,625	60,285	60,285	60,285	63,105
FWNT-24054-S	240 x 54	4	2	4	20	54,283	56,838	56,838	56,838	59,545
FWNT-24060-S	240 x 60	4	2	5	20	60,148	62,838	62,838	62,838	65,691

**OPTIONS**

	CODE	PRICE	NOTES
Power and Data Options			See pages 119-129
<b>Center Column Base Finish Options:</b>			
Painted Center Rectangle Base*	Add -PCR	No Charge	To replace existing middle base (Hoop Base only)
Veneer Center Rectangle Base*	Add -VCR	No Charge	To replace existing middle base (Hoop Base only)
<b>Polished Chrome Finish Options:</b>			
Polished Chrome Hoop Base (on 2 base tables)	Add -PCHP2	\$2,558	*When specifying -VCR or -PCR in conjunction with a Polished Chrome finish on Hoop Base tables with 3 bases, use the upcharge code and pricing for 2 base tables (-PCHP2).
Polished Chrome Hoop Base (on 3 base tables)	Add -PCHP3	\$3,835	
Polished Chrome Hoop Base (on 4 base tables)	Add -PCHP4	\$4,824	
<b>Multi-Section Tops:</b>			
102", 108", 114" and 120" one-piece tops split into two sections	Specify -2	\$761	Note: Power Matrix (center of table location only) cannot be specified when this option is selected
204", 216", 228" or 240" two-piece tops split into four sections	Specify -4	\$1,517	



# STONE / QUARTZ TOP

## EDGE PROFILE

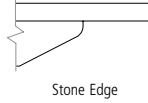

Stone Edge

## GENERAL INFORMATION

- Tops are 2cm thick, cantilevered 3" over a 2" built-up edge subtop
- When Absolute Black Granite stone is specified, the subtop will be painted in Galaxy (S8007)
- When Carrara Marble, Quartz Carrara Codena, or Quartz Serene stone is specified, the subtop will be painted in Cloud (S8004)
- Steel lattice frame replaces the beam structure
- Seating capacity based on 27" per person
- Overall table height 30"
- Stone and Solid Surface Material: Despite its reputation for durability, natural stone can easily be broken during handling and/or installation if proper techniques are not followed. In addition, NuCraft is not responsible for the installation of natural stone or solid surface materials on its products. Therefore, installers specifically trained in the installation of these materials must be utilized to ensure a quality installation. NuCraft shall not be liable for any damages incurred during the handling and/or installation of natural stone or solid surface materials on its products.
- Center Wire Chase available on two base tables for more robust wire management needs. See page 128.
- If Polished Chrome finish is specified on the Hoop Base, the beams will be foil.
- Tables with three Hoop Bases will default to the same base style for all three bases. An alternate Center Rectangle Base may also be specified above.
- One wire manager included with the Hoop Base table (regardless of table size). Can be adhered to the leg and will default to the finish of the leg. If additional wire management channels are required, they can be purchased separately at the end of the pricelist.
- Rectangle and Column bases have a removable access panel

### REQUIRED INFORMATION (ORDER CANNOT BE ENTERED WITHOUT THIS INFORMATION)

See appendix pages vi-vii for surface material options.

- Choose Stone
- Choose Wood Species & Finish, if **-VR** or **-VC** base is selected
- Choose Paint Finish, if **-PR** or **-PC** base is selected
- Choose Metal Finish, if **-HP** base is selected. Clear Anodized (-CA) not available on Hoop Base.



# STONE / QUARTZ TOP

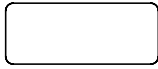

RADIUS RECTANGLE TOP

**BASE KEY**

PR	Painted Rectangle	HP	Metal Hoop	VR	Veneer Rectangle
PC	Painted Column			VC	Veneer Column

**RADIUS RECTANGLE TABLES**

MODEL #	L x W	BASE QTY	SUB-TOP SECTIONS	STONE SECTIONS	SEATING CAPACITY	-PR	-PC	-HP	-VR	-VC
FWNC-8442-S	84 x 42	2	1	1	8	13,949	14,798	14,798	14,798	15,698
FWNC-8448-S	84 x 48	2	1	1	8	15,111	15,990	15,990	15,990	16,921
FWNC-9648-S	96 x 48	2	1	2	8	16,847	17,770	17,770	17,770	18,749
FWNC-10848-S	108 x 48	2	1	2	10	18,784	19,759	19,759	19,759	20,794
FWNC-12048-S	120 x 48	2	1	2	10	20,829	21,856	21,856	21,856	22,944
FWNC-12054-S	120 x 54	2	1	2	12	22,941	24,014	24,014	24,014	25,151
FWNC-14448-S	144 x 48	3	2	2	12	28,726	30,394	30,394	30,394	32,162
FWNC-14454-S	144 x 54	3	2	2	14	31,546	33,288	33,288	33,288	35,135
FWNC-14460-S	144 x 60	3	2	3	14	34,848	36,682	36,682	36,682	38,629
FWNC-15648-S	156 x 48	3	2	3	14	32,149	33,835	33,835	33,835	35,622
FWNC-15654-S	156 x 54	3	2	3	14	35,267	37,028	37,028	37,028	38,894
FWNC-15660-S	156 x 60	3	2	3	14	38,921	40,776	40,776	40,776	42,742
FWNC-16854-S	168 x 54	3	2	3	16	36,770	38,531	38,531	38,531	40,397
FWNC-16860-S	168 x 60	3	2	4	16	40,641	42,496	42,496	42,496	44,462
FWNC-18054-S	180 x 54	3	2	3	16	38,274	40,032	40,032	40,032	41,901
FWNC-18060-S	180 x 60	3	2	4	16	42,361	44,216	44,216	44,216	46,182
FWNC-19254-S	192 x 54	3	2	3	18	39,777	41,536	41,536	41,536	43,402
FWNC-19260-S	192 x 60	3	2	4	18	44,082	45,936	45,936	45,936	47,903
FWNC-20454-S	204 x 54	3	2	3	18	42,955	44,786	44,786	44,786	46,729
FWNC-20460-S	204 x 60	3	2	4	18	47,661	49,590	49,590	49,590	51,635
FWNC-21654-S	216 x 54	3	2	3	20	45,606	47,482	47,482	47,482	49,471
FWNC-21660-S	216 x 60	3	2	4	20	50,658	52,633	52,633	52,633	54,730
FWNC-22854-S	228 x 54	4	2	4	20	52,057	54,582	54,582	54,582	57,261
FWNC-22860-S	228 x 60	4	2	5	20	57,625	60,285	60,285	60,285	63,105
FWNC-24054-S	240 x 54	4	2	4	20	54,283	56,838	56,838	56,838	59,545
FWNC-24060-S	240 x 60	4	2	5	20	60,148	62,838	62,838	62,838	65,691

**OPTIONS**

	CODE	PRICE	NOTES
Power and Data Options			See pages 119-129
<b>Center Column Base Finish Options:</b>			
Painted Center Rectangle Base*	Add -PCR	No Charge	To replace existing middle base (Hoop Base only)
Veneer Center Rectangle Base*	Add -VCR	No Charge	To replace existing middle base (Hoop Base only)
<b>Polished Chrome Finish Options:</b>			
Polished Chrome Hoop Base (on 2 base tables)	Add -PCHP2	\$2,558	*When specifying -VCR or -PCR in conjunction with a Polished Chrome finish on Hoop Base tables with 3 bases, use the upcharge code and pricing for 2 base tables (-PCHP2).
Polished Chrome Hoop Base (on 3 base tables)	Add -PCHP3	\$3,835	
Polished Chrome Hoop Base (on 4 base tables)	Add -PCHP4	\$4,824	
<b>Multi-Section Tops:</b>			
102", 108", 114" and 120" one-piece tops split into two sections	Specify -2	\$761	Note: Power Matrix (center of table location only) cannot be specified when this option is selected
204", 216", 228" or 240" two-piece tops split into four sections	Specify -4	\$1,517	



# STONE / QUARTZ TOP

## EDGE PROFILE

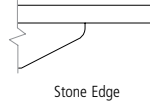

Stone Edge

## GENERAL INFORMATION

- Tops are 2cm thick, cantilevered 3" over a 2" built-up edge subtop
- When Absolute Black Granite stone is specified, the subtop will be painted in Galaxy (S8007)
- When Carrara Marble, Quartz Carrara Codena, or Quartz Serene stone is specified, the subtop will be painted in Cloud (S8004)
- Steel lattice frame replaces the beam structure
- Seating capacity based on 27" per person
- Overall table height 30"
- Stone and Solid Surface Material: Despite its reputation for durability, natural stone can easily be broken during handling and/or installation if proper techniques are not followed. In addition, Nucraft is not responsible for the installation of natural stone or solid surface materials on its products. Therefore, installers specifically trained in the installation of these materials must be utilized to ensure a quality installation. Nucraft shall not be liable for any damages incurred during the handling and/or installation of natural stone or solid surface materials on its products.
- Center Wire Chase available on two base tables for more robust wire management needs. See page 128.
- If Polished Chrome finish is specified on the Hoop Base, the beams will be foil.
- Tables with three Hoop Bases will default to the same base style for all three bases. An alternate Center Rectangle Base may also be specified above.
- One wire manager included with the Hoop Base table (regardless of table size). Can be adhered to the leg and will default to the finish of the leg. If additional wire management channels are required, they can be purchased separately at the end of the pricelist.
- Rectangle and Column bases have a removable access panel

### REQUIRED INFORMATION (ORDER CANNOT BE ENTERED WITHOUT THIS INFORMATION)

See appendix pages vi-vii for surface material options.

- Choose Stone
- Choose Wood Species & Finish, if **-VR** or **-VC** base is selected
- Choose Paint Finish, if **-PR** or **-PC** base is selected
- Choose Metal Finish, if **-HP** base is selected. Clear Anodized (-CA) not available on Hoop Base.



# STONE / QUARTZ TOP

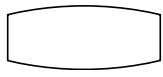

BOAT TOP

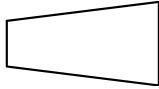

SIGHT LINE TOP

**BASE KEY**

PR	Painted Rectangle	HP	Metal Hoop	VR	Veneer Rectangle
PC	Painted Column			VC	Veneer Column

**BOAT TABLES**

MODEL #	L x W	BASE QTY	SUB-TOP SECTIONS	STONE SECTIONS	SEATING CAPACITY	-PR	-PC	-HP	-VR	-VC
FWNB-8444-S	84 x 32/44	2	1	1	8	14,658	15,537	-	15,537	16,468
FWNB-10848-S	108 x 36/48	2	1	2	10	18,784	19,759	19,759	19,759	20,794
FWNB-14454-S	144 x 36/54	3	2	2	12	31,546	33,288	33,288	33,288	35,135
FWNB-16860-S	168 x 42/60	3	2	4	14	40,641	42,496	42,496	42,496	44,462
FWNB-19272-S	192 x 54/72	3	4	4	18	57,685	59,651	59,651	59,651	61,736
FWNB-20472-S	204 x 54/72	3	4	4	18	62,579	64,626	64,626	64,626	66,795
FWNB-21672-S	216 x 54/72	3	4	4	20	66,720	68,815	68,815	68,815	71,039
FWNB-22872-S	228 x 54/72	4	4	5	20	74,907	77,728	77,728	77,728	80,721
FWNB-24072-S	240 x 54/72	4	4	5	20	78,425	81,278	81,278	81,278	84,302

**SIGHT LINE TABLES**

MODEL #	L x W	BASE QTY	SUB-TOP SECTIONS	STONE SECTIONS	SEATING CAPACITY	-PR	-PC	-HP	-VR	-VC
FWNA-8458-S	84 x 36/58	2	1	2	9	17,870	18,836	18,836	18,836	19,861
FWNA-10860-S	108 x 36/60	2	1	2	11	22,800	23,874	23,874	23,874	25,012
FWNA-13268-S	132 x 36/68	3	3	3	11	40,192	42,062	42,062	42,062	44,047
FWNA-15672-S	156 x 36/72	3	3	3	13	50,331	52,297	52,297	52,297	54,383
FWNA-16876-S	168 x 36/76	3	3	4	15	52,847	54,757	54,757	54,757	56,783
FWNA-18078-S	180 x 36/78	3	3	4	15	56,182	58,092	58,092	58,092	60,116
FWNA-19278-S	192 x 36/78	3	4	4	17	58,731	60,642	60,642	60,642	62,667
FWNA-20478-S	204 x 36/78	3	4	4	17	63,769	65,757	65,757	65,757	67,865
FWNA-21678-S	216 x 36/78	3	4	4	19	68,043	70,079	70,079	70,079	72,239
FWNA-22878-S	228 x 36/78	4	4	5	19	76,209	78,949	78,949	78,949	81,856
FWNA-24078-S	240 x 36/78	4	4	5	19	79,846	82,616	82,616	82,616	85,556

**OPTIONS**

Power and Data Options

See pages 119-129

**Center Column Base Finish Options:**

Painted Center Rectangle Base*	Add <b>-PCR</b>	No Charge	To replace existing middle base (Hoop Base only)
Veneer Center Rectangle Base*	Add <b>-VCR</b>	No Charge	To replace existing middle base (Hoop Base only)

**Polished Chrome Finish Options:**

Polished Chrome Hoop Base (on 2 base tables)	Add <b>-PCHP2</b>	\$2,558	*When specifying -VCR or -PCR in conjunction with a Polished Chrome finish on Hoop Base tables with 3 bases, use the upcharge code and pricing for 2 base tables (-PCHP2).
Polished Chrome Hoop Base (on 3 base tables)	Add <b>-PCHP3</b>	\$3,835	
Polished Chrome Hoop Base (on 4 base tables)	Add <b>-PCHP4</b>	\$4,824	

**Multi-Section Tops:**

102", 108", 114" and 120" one-piece tops split into two sections	Specify -2	\$761	Note: Power Matrix (center of table location only) cannot be specified when this option is selected
--	------------	-------	---



# STONE / QUARTZ TOP

## EDGE PROFILE

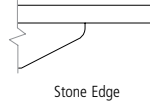

Stone Edge

## GENERAL INFORMATION

- Tops are 2cm thick, cantilevered 3" over a 2" built-up edge subtop
- When Absolute Black Granite stone is specified, the subtop will be painted in Galaxy (S8007)
- When Carrara Marble, Quartz Carrara Codena, or Quartz Serene stone is specified, the subtop will be painted in Cloud (S8004)
- Steel lattice frame replaces the beam structure
- Seating capacity based on 27" per person
- Overall table height 30"
- Stone and Solid Surface Material: Despite its reputation for durability, natural stone can easily be broken during handling and/or installation if proper techniques are not followed. In addition, Nucraft is not responsible for the installation of natural stone or solid surface materials on its products. Therefore, installers specifically trained in the installation of these materials must be utilized to ensure a quality installation. Nucraft shall not be liable for any damages incurred during the handling and/or installation of natural stone or solid surface materials on its products.
- Center Wire Chase available on two base tables for more robust wire management needs. See page 128.
- If Polished Chrome finish is specified on the Hoop Base, the beams will be foil.
- Tables with three Hoop Bases will default to the same base style for all three bases. An alternate Center Rectangle Base may also be specified above.
- One wire manager included with the Hoop Base table (regardless of table size). Can be adhered to the leg and will default to the finish of the leg. If additional wire management channels are required, they can be purchased separately at the end of the pricelist.
- Rectangle and Column bases have a removable access panel

### REQUIRED INFORMATION (ORDER CANNOT BE ENTERED WITHOUT THIS INFORMATION)

See appendix pages vi-vii for surface material options.

- Choose Stone
- Choose Wood Species & Finish, if **-VR** or **-VC** base is selected
- Choose Paint Finish, if **-PR** or **-PC** base is selected
- Choose Metal Finish, if **-HP** base is selected. Clear Anodized (-CA) not available on Hoop Base.



# POWER AND DATA OPTIONS

POWER MATRIX SMALL OR COMPACT	MODEL #	DESCRIPTION	W x D	SIMPLEX OUTLETS	BLANK	DATA*	PRICE
	PM-SM-G	Small - Glass Door	6 x 5.375	2	2	2	1,489
	PM-SM-M	Small - Metal Door	6 x 5.375	2	2	2	1,489
	PM-SM-W	Small - Wood Door	6 x 5.375	2	2	2	1,878
	PM-SM-G-C	Compact - Glass Door	6 x 5.375	2	2	2	1,489
	PM-SM-M-C	Compact - Metal Door	6 x 5.375	2	2	2	1,489
	PM-SM-W-C	Compact - Wood Door	6 x 5.375	2	2	2	1,878

\*Each data faceplate includes two RJ-45 (Data) connectors

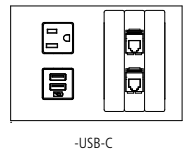
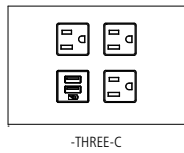
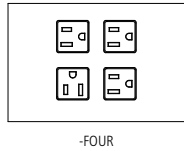

OPTIONS	CODE	PRICE	NOTES
4 Simplex Receptacles	Add <b>-FOUR</b>	No Charge	Replace AAP's with 2 additional simplex receptacles
3 Simplex Receptacles/Charging USB-A+C	Add <b>-THREE-C</b>	No Charge	Replace AAP's with 1 additional simplex receptacle and 1 charging USB-A+C
USB-A+C Charging	Add <b>-USB-C</b>	\$116 per unit	USB-A+C charger, replaces one of the simplex outlets
Polished Chrome Door	Add <b>-PD</b>	\$223 per unit	Only available with metal door option
Polished Chrome Bezel	Add <b>-PB</b>	\$317 per unit	Only available on glass, stone and laminate top tables
Field-Wired	Add <b>-FW</b>	Deduct \$43 per unit	May be required in New York City, Chicago and San Francisco. Check with an electrician for local codes and requirements.
Single Infeed Option Available	See page 123		

### GENERAL INFORMATION

- Wood species and finish will default to the same as the table top if wood door version is specified
- Power Matrix cord is 144"-long
- Glass & wood doors are 1/4"-thick, metal doors are 1/8"-thick
- Glass door is back-painted low-iron glass
- Interior body is clear anodized aluminum
- Each unit includes a 15 amp, 12' power infeed (plug in only)
- If Field-Wired option is specified, each unit includes a 6' flexible metal conduit and requires a hardwire connection
- Standard configuration: Two simplex receptacles, two RJ-45 data connectors and two single blank faceplates
- When specified on tables with laminate tops, each Power Matrix unit will include a metal bezel and is limited to the glass and metal door options. (-B) will be added to the model number for the bezel.
- Additional data/AV faceplate options are on page 128

### REQUIRED INFORMATION: (ORDER CANNOT BE ENTERED WITHOUT THIS INFORMATION)

See appendix pages vi-vii for surface material options.

- Choose location code & quantity from the charts on pages 17-18
- Choose Glass Door Finish, if glass door version is specified
- Choose Metal Finish, if metal door version is specified or for the bezel finish on laminate tables

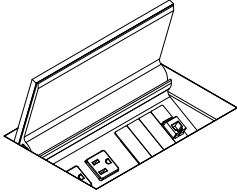

# POWER AND DATA OPTIONS

POWER MATRIX MEDIUM	MODEL #	DESCRIPTION	W x D	SIMPLEX OUTLETS	BLANK	DATA*	PRICE
	PM-MD-G	Medium - Glass Door	6 x 8.25	4	3	1	2,347
	PM-MD-M	Medium - Metal Door	6 x 8.25	4	3	1	2,347
	PM-MD-W	Medium - Wood Door	6 x 8.25	4	3	1	2,739

\*Each data faceplate includes two RJ-45 (Data) connectors

OPTIONS	CODE	PRICE	NOTES
USB-A+C Charging	Add <b>-USB-C</b>	\$116 per unit	USB-A+C charger, replaces one of the simplex outlets
Polished Chrome Door	Add <b>-PD</b>	\$301 per unit	Only available with metal door option
Polished Chrome Bezel	Add <b>-PB</b>	\$354 per unit	Only available on glass, stone and laminate top tables
Field-Wired	Add <b>-FW</b>	Deduct \$43 per unit	May be required in New York City, Chicago and San Francisco. Check with an electrician for local codes and requirements.
Single Infeed Option Available	See page 123		

### GENERAL INFORMATION

- Wood species and finish will default to the same as the table top if wood door version is specified
- Glass & wood doors are 1/4" -thick, metal doors are 1/8" -thick
- Glass door is back-painted low-iron glass
- Interior body is clear anodized aluminum
- Each unit includes a 15 amp, 12' power infeed (plug in only)
- If Field-Wired option is specified, each unit includes a 6' flexible metal conduit and requires a hardwire connection
- Standard configuration: Four simplex receptacles, two RJ-45 data connectors and three single blank faceplates
- When specified on tables with laminate, glass or stone/quartz tops, each Power Matrix unit will include a metal bezel and is limited to the glass and metal door options. (-B) will be added to the model number for the bezel.
- Additional data/AV faceplate options are on page 128

### REQUIRED INFORMATION: (ORDER CANNOT BE ENTERED WITHOUT THIS INFORMATION)

See appendix pages vi-vii for surface material options.

- Choose location code & quantity from the charts on pages 17-18
- Choose Glass Door Finish, if glass door version is specified
- Choose Metal Finish, if metal door version is specified or for the bezel finish on laminate and glass tables





# POWER AND DATA OPTIONS

POWER MATRIX LARGE	MODEL #	DESCRIPTION	W x D	SIMPLEX OUTLETS	BLANK	DATA*	PRICE
	PM-LG-G	Large - Glass Door	15.25 x 10.75	6	4	2	3,912
	PM-LG-M	Large - Metal Door	15.25 x 10.75	6	4	2	3,912
	PM-LG-W	Large - Wood Door	15.25 x 10.75	6	4	2	4,535

\*Each data faceplate includes two RJ-45 (Data) connectors

OPTIONS	CODE	PRICE	NOTES
USB-A+C Charging	Add <b>-USB-C</b>	\$226 per unit	USB-A+C charger, replaces one of the simplex outlets per side
Polished Chrome Door	Add <b>-PD</b>	\$738 per unit	Only available with metal door option
Polished Chrome Bezel	Add <b>-PB</b>	\$571 per unit	Only available on glass, stone and laminate top tables
Field-Wired	Add <b>-FW</b>	Deduct \$78 per unit	May be required in New York City, Chicago and San Francisco. Check with an electrician for local codes and requirements.
Single Infeed Option Available	See page 123		

### GENERAL INFORMATION

- Wood species and finish will default to the same as the table top if wood door version is specified
- Glass & wood doors are 1/4"-thick, metal doors are 1/8"-thick
- Glass door is back-painted low-iron glass
- Interior body is clear anodized aluminum
- Each unit includes a 15 amp, 12' power infeed (plug in only)
- If Field-Wired option is specified, each unit includes a 6' flexible metal conduit and requires a hardwire connection
- Standard configuration: Six simplex receptacles, four RJ-45 data connectors and four single blank faceplates
- When specified on tables with laminate tops, each Power Matrix unit will include a metal bezel and is limited to the glass and metal door options. (-B) will be added to the model number for the bezel.
- Additional data/AV faceplate options are on page 128

### REQUIRED INFORMATION: (ORDER CANNOT BE ENTERED WITHOUT THIS INFORMATION)

See appendix pages vi-vii for surface material options.

- Choose location code & quantity from the charts on pages 17-18
- Choose Glass Door Finish, if glass door version is specified
- Choose Metal Finish, if metal door version is specified or for the bezel finish on laminate tables



# POWER AND DATA OPTIONS

POWER MATRIX EXTRA LARGE	MODEL #	DESCRIPTION	W x D	SIMPLEX OUTLETS	BLANK	DATA*	PRICE
	PM-XL-G	Extra Large - Glass Door	30.25 x 10.75	8	8	4	5,472
	PM-XL-M	Extra Large - Metal Door	30.25 x 10.75	8	8	4	5,472
	PM-XL-W	Extra Large - Wood Door	30.25 x 10.75	8	8	4	6,099

\*Each data faceplate includes two RJ-45 (Data) connectors

OPTIONS	CODE	PRICE	NOTES
USB-A+C Charging	Add <b>-USB-C</b>	\$226 per unit	USB-A+C charger, replaces one of the simplex outlets per side
Polished Chrome Door	Add <b>-PD</b>	\$1,035 per unit	Only available with metal door option
Polished Chrome Bezel	Add <b>-PB</b>	\$744 per unit	Only available on glass, stone and laminate top tables
Field-Wired	Add <b>-FW</b>	Deduct \$78 per unit	May be required in New York City, Chicago and San Francisco. Check with an electrician for local codes and requirements.
Single Infeed Option Available	See page 123		

### GENERAL INFORMATION

- Wood species and finish will default to the same as the table top if wood door version is specified
- Glass & wood doors are 1/4"-thick, metal doors are 1/8"-thick
- Glass door is back-painted low-iron glass
- Interior body is clear anodized aluminum
- Each unit includes a 15 amp, 12' power infeed (plug in only)
- If Field-Wired option is specified, each unit includes a 6' flexible metal conduit and requires a hardwire connection
- Standard configuration: Eight simplex receptacles, eight RJ-45 data connectors and eight single blank faceplates
- When specified on tables with laminate tops, each Power Matrix unit will include a metal bezel and is limited to the glass and metal door options. (-B) will be added to the model number for the bezel.
- Additional data/AV faceplate options are on page 128

### REQUIRED INFORMATION: (ORDER CANNOT BE ENTERED WITHOUT THIS INFORMATION)

See appendix pages vi-vii for surface material options.

- Choose location code & quantity from the charts on pages 17-18
- Choose Glass Door Finish, if glass door version is specified
- Choose Metal Finish, if metal door version is specified or for the bezel finish on laminate tables



# POWER AND DATA OPTIONS

SINGLE INFEED OPTION	MODEL #	DESCRIPTION	PRICE
	SI-H	Single In-Feed Option, Hard-wired	553
	SI-C	Single In-Feed Option, Corded (Plug-in)	668

### GENERAL INFORMATION

- Tables 72"-120" in length include 2 duplex receptacles with the modular power system
- Tables 132"-240" in length include 3 duplex receptacles with the modular power system
- Hardwired and Corded Single Infeed options are 7' long
- Single Infeed option cannot be specified in conjunction with the Field-Wired (-FW) option
- Corded Single Infeed option will require a 20-amp power outlet in the floor monument and reduces the modular electrical system in the table to a single circuit

RETRACTORS	MODEL #	DESCRIPTION	PRICE
	CR-CAT6	CAT6 Retractor	907
	CR-HDMI	HDMI Retractor	907
	CR-DISPLAY	Display Port Retractor	907
	CR-USB	Data USB Retractor	907

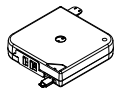

CR-HDMI

### GENERAL INFORMATION

- Mounting bracket and attaching hardware included with each retractor
- Can only be used with Power Matrix Small or Medium units
- Not available on round tables
- One Cable Pass Through Set (one top, one bottom) AAP FLDF-14 included. Double style AAP
- See page 22 for availability by table size

### Retractor Wire Management

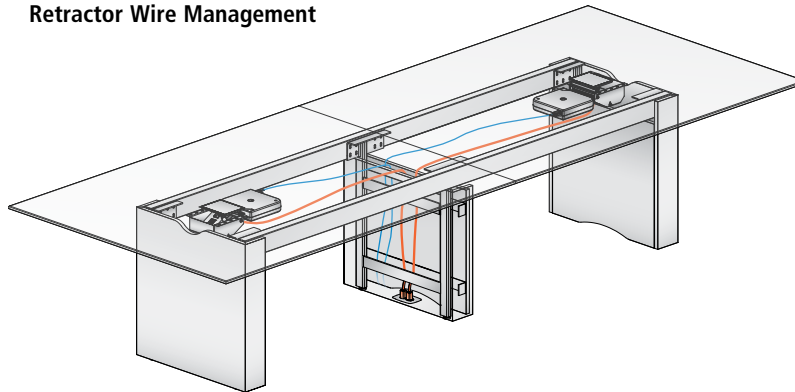

POWER DOT	MODEL #	DESCRIPTION	PRICE
	PDOT1	2 simplex	377
	PDOT2	1 simplex, 1 data	377
	PDOT3-C	1 simplex, 1 USB-A+C	479



PDOT3-C

### POWER DOT LOCATION CO

PD-36 1 Power Dot centrally located for table desk applications

OPTIONS	CODE	PRICE	NOTES
Field-Wired	Add <b>-FW</b>	No Charge	May be required in New York City, Chicago and San Francisco. Check with an electrician for local codes and requirements.

### GENERAL INFORMATION

- Power Dot option includes 72" power cord. PDOT2 includes one open data port. Voice/data modules must be ordered separately. Contact your local AV integrator.

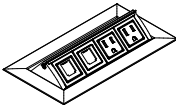

# POWER AND DATA OPTIONS

TECH NODE	MODEL #	W X D	SIMPLEX RECEPTACLES	OPEN DATA PORTS	CHARGING USB-A+C	PRICE
 PUP	PUP	8 x 4	2	2	-	543
	PUP-USB-AC	8 x 4	2	1	1	647



OPTIONS	CODE	PRICE	NOTES
Field-Wired	Add <b>-FW</b>	No Charge	May be required in New York City, Chicago and San Francisco. Check with an electrician for local codes and requirements.

### GENERAL INFORMATION

- 12' cord and a 15 amp plug-in power infeed
- Voice/data modules must be ordered separately; contact your local AV integrator
- PUP defaults to color of metal finish specified on tables (Shadow, Storm, Black, Aged Bronze, Satin Bronze and Galaxy receive Black Anodized Tech Node; Cloud, Burnished and Foil receive Clear Anodized Tech Node)
- Round tables with cylinder bases do not have visible metal components, specify metal finish for Tech Node: Clear or Black Anodized
- Includes a Voice/Data Adapter Kit to accept couplers and jacks when required
- UL Listed

**REQUIRED INFORMATION: (ORDER CANNOT BE ENTERED WITHOUT THIS INFORMATION)**

- See appendix pages vi-vii for surface material options.
- Choose location code and quantity from chart below



POWER SPEC	MODEL #	DESCRIPTION	PRICE
 PWR-R-W	PWR-R-B	Round Power Spec with Black Faceplate	116
	PWR-R-W	Round Power Spec with White Faceplate	116
 PWR-SQ-W	PWR-SQ-B	Square Power Spec with Black Faceplate	116
	PWR-SQ-W	Square Power Spec with Faceplate	116

### GENERAL INFORMATION

- Includes one simplex receptable
- 12' cord

**REQUIRED INFORMATION: (ORDER CANNOT BE ENTERED WITHOUT THIS INFORMATION)**

- See appendix pages vi-vii for surface material options.
- Choose Metal Finish: Satin Nickel (SNB) or Chrome (CB)

USB SPEC	MODEL #	DESCRIPTION	PRICE
 USBC-R	USBC-R-B	Round Data Spec with Black Faceplate	243
	USBC-R-W	Round Data Spec with White Faceplate	243
 USBC-SQ	USBC-SQ-B	Square Data Spec with Black Faceplate	243
	USBC-SQ-W	Square Data Spec with White Faceplate	243

### GENERAL INFORMATION

- Includes one charging USB-A+C
- 6' cord

**REQUIRED INFORMATION: (ORDER CANNOT BE ENTERED WITHOUT THIS INFORMATION)**

- See appendix pages vi-vii for surface material options.
- Choose Metal Finish: Satin Nickel (SNB) or Chrome (CB)



# POWER AND DATA OPTIONS

GROMMET	MODEL #	DESCRIPTION	DIAMETER	PRICE
	GR	Round Grommet	2" Dia	220



OPTIONS	CODE	PRICE	NOTES
Polished Chrome Grommet	Add <b>-PCG</b>	\$86 per unit	

### GENERAL INFORMATION

- Metal finish will default to the metal chosen for the table unless otherwise specified
- Available at center location only

**REQUIRED INFORMATION: (ORDER CANNOT BE ENTERED WITHOUT THIS INFORMATION)**

- See appendix pages vi-vii for surface material options.
- Choose Metal Finish: Powder Coat, Clear Anodized or Polished Chrome (upcharge applies)

LOCATION CODES	TECH NODE	POWER SPEC	USB SPEC	ROUND GROMMET	LOCATION	QUANTITY OF UNITS TO ORDER
	TN-1	SP-1	SP-1	G-1	One at center	1
	TN-2	SP-2	SP-2		One at each end	2
	TN-3	SP-3	SP-3		One at center and one at each end	3
	TN-4	SP-4	SP-4		Four equally spaced	4

PERIMETER POWER	MODEL #	TABLE LENGTH	ELECTRICAL OUTLETS	TOTAL BRACKETS	BRACKETS PER SIDE	PRICE
	PER-96	96	12	6	2	5,708
	PER-102	102	12	6	2	5,708
	PER-108	108	12	6	2	5,708
	PER-114	114	12	6	2	5,708
	PER-120	120	12	6	2	5,708
	PER-132	132	12	6	2	5,708
	PER-144	144	16	8	3	7,609
	PER-156	156	16	8	3	7,609
	PER-168	168	16	8	3	7,609
	PER-180	180	16	8	3	7,609
	PER-192	192	16	8	3	7,609
	PER-204	204	16	8	3	7,609
	PER-216	216	20	10	4	9,506
	PER-228	228	20	10	4	9,506
	PER-240	240	20	10	4	10,895

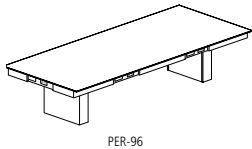

PER-96

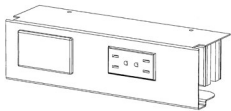

Power Bracket

OPTIONS	CODE	PRICE	NOTES
Field-Wired Options:			
96"-120" Tables	Add <b>-FW</b>	DEDUCT \$1,789	Some local electrical codes may require hardwiring of components and may not allow the use of standard modular power systems. A junction box will be provided when ordering the -FW option
132"-192" Tables	Add <b>-FW</b>	DEDUCT \$2,187	
204"-240" Tables	Add <b>-FW</b>	DEDUCT \$2,679	

### GENERAL INFORMATION

- Available on Rectangle, Sight Line and Boat tops
- Wood species and finish will default to the same as the table top
- One Power Bracket per end
- All electrical components included (unless **-FW** option is chosen)
- 24-3/4" clearance from floor to underside of apron
- Not available on Flow tables with Four Post base or on Round tables
- Not available on Stone Top tables

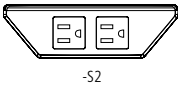
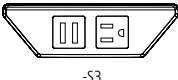

# POWER AND DATA OPTIONS

HARDWIRE INFEED POWER RAIL KIT	MODEL #	TOTAL # OF RAILS	ELECTRICAL OUTLETS	(2) SIMPLEX -S2	ELECTRICAL OUTLETS	(1) SIMPLEX / (1) CHARGING USB-A+C -S3
(Includes Power Rails, Hardwire Infeed and Modular Power Components)   -S2   -S3	FW-RAIL-1-H	1	2	1,331	1	1,331
	FW-RAIL-2-H	2	4	2,114	2	2,114
	FW-RAIL-3-H	3	6	2,895	3	2,895
	FW-RAIL-4-H	4	8	3,677	4	3,677
	FW-RAIL-5-H	5	10	4,459	5	4,459
	FW-RAIL-6-H	6	12	5,239	6	5,239
	FW-RAIL-7-H	7	14	6,019	7	6,019
	FW-RAIL-8-H	8	16	6,800	8	6,800
	FW-RAIL-9-H	9	18	7,583	9	7,583
	FW-RAIL-10-H	10	20	8,365	10	8,365
	FW-RAIL-11-H	11	22	9,145	11	9,145
	FW-RAIL-12-H	12	24	9,926	12	9,926

**GENERAL INFORMATION**

- Includes modular power electrical system
- Hardwire infeed is 7' long
- Not available on Stone Top tables
- Maximum of 12 Power Rails per table
- Simplex receptacles will be white, when Burnished, Cloud or Foil powdercoat finishes are specified. Black simplex receptacles will be used for all other powdercoat finishes.
- Power Rails not available in Clear or Black Anodized

**REQUIRED INFORMATION: (ORDER CANNOT BE ENTERED WITHOUT THIS INFORMATION)**

- See appendix pages vi-vii for surface material options.
- Choose Metal Finish

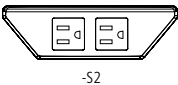
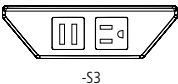
CORDED INFEED POWER RAIL KIT	MODEL #	TOTAL # OF RAILS	ELECTRICAL OUTLETS	(2) SIMPLEX -S2	ELECTRICAL OUTLETS	(1) SIMPLEX / (1) CHARGING USB-A+C -S3
(Includes Power Rails, Corded Infeed and Modular Power Components)   -S2   -S3	FW-RAIL-1-C	1	2	1,448	1	1,448
	FW-RAIL-2-C	2	4	2,232	2	2,232
	FW-RAIL-3-C	3	6	3,012	3	3,012
	FW-RAIL-4-C	4	8	3,792	4	3,792
	FW-RAIL-5-C	5	10	4,573	5	4,573
	FW-RAIL-6-C	6	12	5,357	6	5,357
	FW-RAIL-7-C	7	14	6,138	7	6,138
	FW-RAIL-8-C	8	16	6,918	8	6,918
	FW-RAIL-9-C	9	18	7,699	9	7,699
	FW-RAIL-10-C	10	20	8,481	10	8,481
	FW-RAIL-11-C	11	22	9,264	11	9,264
	FW-RAIL-12-C	12	24	10,044	12	10,044

**GENERAL INFORMATION**

- Not available on Stone Top tables
- Data rails do not count toward the maximum of 12 Power Rails per table. For information on how many Data Rails a specific table size can accommodate, please contact Nucraft Customer Service.
- Data Rails not available in Clear or Black Anodized
- Corded Single Infeed option will require a 20-amp power outlet in the floor monument and reduces the modular electrical system in the table to a single circuit

**REQUIRED INFORMATION: (ORDER CANNOT BE ENTERED WITHOUT THIS INFORMATION)**

- See appendix pages vi-vii for surface material options.
- Choose Metal Finish

DATA RAIL	MODEL #	DESCRIPTION	PRICE
 FW-RAIL-DATA	FW-RAIL-DATA	Data Rail includes (1) blank faceplate and (1) dual RJ-45 faceplate	604

**GENERAL INFORMATION**

- Not available on Stone Top tables
- Data rails do not count toward the maximum of 12 Power Rails per table. For information on how many Data Rails a specific table size can accommodate, please contact Nucraft Customer Service.
- Data Rails not available in Clear or Black Anodized

**REQUIRED INFORMATION: (ORDER CANNOT BE ENTERED WITHOUT THIS INFORMATION)**

- See appendix pages vi-vii for surface material options.
- Choose Metal Finish



# POWER AND DATA OPTIONS

FIELD-WIRED	MODEL #	DESCRIPTION	(2) SIMPLEX -S2	(1) SIMPLEX / (1) CHARGING USB-A+C -S3
	FW-RAIL-FW	Field-Wired Power Rail	696	696

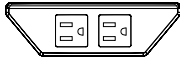

-S2

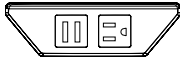

-S3

**GENERAL INFORMATION**

- Includes 6' flexible metal conduit and required a hardwire connection
- Not available on Stone Top tables
- Maximum of 12 Power Rails per table
- May be required in New York City, Chicago and San Francisco. Check with an electrician for local codes and requirements. A junction box will be provided when ordering the FW-RAIL-FW option.
- Power Rails not available in Clear or Black Anodized

**REQUIRED INFORMATION: (ORDER CANNOT BE ENTERED WITHOUT THIS INFORMATION)**

See appendix pages vi-vii for surface material options.

- Choose Metal Finish

INDIVIDUAL POWER RAIL	MODEL #	DESCRIPTION	(2) SIMPLEX -S2	(1) SIMPLEX / (1) CHARGING USB-A+C -S3
	FW-RAIL	Power Rail	784	784

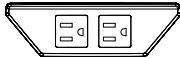

-S2



-S3

**GENERAL INFORMATION**

- Individual power rails do not include a modular power system. Each Power Rail must directly plug into a floor core with a 6'-corded 15-amp plug-in infeed. (Typically used with smaller tables, rounds, squares, soft squares, where a modular power system is not required.)
- Not available on Stone Top tables
- Maximum of 12 Power Rails per table
- Simplex receptacles will be white, when Burnished, Cloud or Foil powdercoat finishes are specified. Black simplex receptacles will be used for all other powdercoat finishes.
- Power Rails not available in Clear or Black Anodized

**REQUIRED INFORMATION: (ORDER CANNOT BE ENTERED WITHOUT THIS INFORMATION)**

See appendix pages vi-vii for surface material options.

- Choose Metal Finish



# POWER AND DATA OPTIONS

DATA FACEPLATES	MODEL #	DESCRIPTION	STYLE	W x H	PRICE
	FLDF-1	Blank faceplate, single height	Single	3-1/2 x 5/8	74
	FLDF-2	One VGA 15-pin HD Female to Female Gender Changer, one 3.5mm Stereo Mini Jack to Solder Tabs	Single	3-1/2 x 5/8	259
	FLDF-3	One VGA 15-pin HD Female to Female Gender Changer	Single	3-1/2 x 5/8	203
	FLDF-4	One RJ-11 Female to Punch Down - Phone	Single	3-1/2 x 5/8	203
	FLDF-5	One RJ-45 Female to Female Barrel - Data	Single	3-1/2 x 5/8	166
	FLDF-6	Two RJ-45 Female to Female Barrels, single height	Single	3-1/2 x 5/8	223
	FLDF-7	Two RJ-45 Female to Punch Down for CAT 6 - AMP	Single	3-1/2 x 5/8	315
	FLDF-8	Two RJ-45 Female to Punch Down for CAT 6 - Leviton	Single	3-1/2 x 5/8	315
	FLDF-10	Two RJ-45 Female to Punch Down for CAT 6 - Panduit	Single	3-1/2 x 5/8	315
	FLDF-11	Two USB A Female to Two USB A Female on 10" Pigtails	Single	3-1/2 x 5/8	352
	FLDF-12	Blank faceplate, double height	Double	3-1/2 x 1-3/8	92
	FLDF-13	Two RJ-45 Female to Female Barrels, double height	Double	3-1/2 x 1-3/8	223
	FLDF-14	Cable Pass-Through Set - one top, one bottom	Double	3-1/2 x 1-3/8	389
	FLDF-15	One HDMI Female to Female Barrel	Single	3-1/2 x 5/8	259

### GENERAL INFORMATION

- All connectors and faceplates are Extron® Architectural Adapter Plates (AAP)
- Each FW-RAIL-DATA unit holds two Single Space faceplates
- Faceplates are black

CHARGING TRAC	MODEL #	TOTAL BRACKETS	# OF USB PORTS	PRICE
	TRAC-2	2	4	2,019
	TRAC-4	4	8	3,406

### GENERAL INFORMATION

- Plug-in Infeed only
- Field Installed
- 15 amp

#### REQUIRED INFORMATION: (ORDER CANNOT BE ENTERED WITHOUT THIS INFORMATION)

See appendix pages vi-vii for surface material options.

- Choose Metal Finish

WIRE CHASE	MODEL #	W x D	DESCRIPTION	PRICE
	FWCB-V	24 x 12	Veneer Center Column Wire Chase	900
	FWCB-P	24 x 12	Paint Center Column Wire Chase	900

### GENERAL INFORMATION

- Wire Chase option to be used with two base tables (not for structural support)
- Wire Management opening is 8.3" x 20"

#### REQUIRED INFORMATION: (ORDER CANNOT BE ENTERED WITHOUT THIS INFORMATION)

See appendix pages vi-vii for surface material options.

- Choose Veneer Finish, if applicable
- Choose Paint Finish, if applicable
- Choose Metal Finish

WIRE MANAGER	MODEL #	DESCRIPTION	PRICE
(shown attached to Hoop Base)	WM	Wire Manager for Hoop Base	386

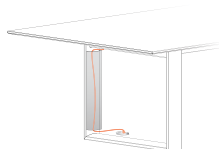

OPTIONS	CODE	PRICE	NOTES
Polished Chrome Finish	Add -PCF	\$371	

#### REQUIRED INFORMATION: (ORDER CANNOT BE ENTERED WITHOUT THIS INFORMATION)

See appendix pages vi-vii for surface material options.

- Choose Metal Finish





# FREESTANDING POWER OPTION

TECH ZONE	MODEL #	DESCRIPTION	SIMPLEX OUTLETS	OPEN DATA PORTS	CHARGING USB-A+C	PRICE
	ZONE-DATA	(2) Simplex receptacles, (2) Open data ports	2	2	-	341
	ZONE-USB-C	(2) Simplex receptacles, (1) Charging USB-A+C, (1) Open data port	2	1	1	408

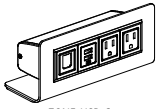

ZONE-USB-C



ZONE-DATA



ZONE-USB-C

## GENERAL INFORMATION

- 72" long plug-in infeed cord
- Finish is black
- Includes a Voice/Data Adapter Kit to accept couplers and jacks when required



# Appendix

---



# GENERAL INFORMATION

This price book supercedes all previous versions.

**Before placing your order, confirm you have all required information necessary. Lead times for orders begin after all required information is included and correct.**

## Delivery Information

We know lead times are important and sticking to them even more so. We work to maintain a 6-8 week lead time on all standard products in this book from receipt of a clean order. All orders are acknowledged with an approximate shipping date and will be invoiced with the price in effect at the date the purchase order is received.

Shipping charges are prepaid (within the continental U.S.). Therefore, pricing is a delivered price based on normal ground transportation. If you have special instructions, need to ship by air, or are shipping to Alaska or Hawaii, contact Nucraft Customer Service. Nucraft can also help arrange to have products blanket wrapped for an additional charge. Contact the Nucraft Customer Service team or specify it on your purchase order.

**Minimum Freight Charge: Any order below \$2,800 net will be assessed a \$450 net minimum freight charge (one per order).**

Orders are subject to acquiring the materials required for manufacturing. Fulfillment can be affected by strikes, fires, embargoes and acts of government. These elements are beyond our control.

Nucraft offers a variety of services to accommodate a wide range of delivery requirements. Availability of these services is dependent on a number of factors and may not be offered with all shipments. Examples of delivery services that have additional fees include:

- Specific date within our standard 3-5 day delivery window (for orders under \$50,000 net)
- Specific time of day, morning or afternoon (for orders under \$50,000 net)
- Delivery to a warehouse before delivery to its final destination (unless product is picked up at the warehouse)

Contact the Nucraft Customer Service team for availability and pricing on these services.

## Freight Terms

Shipping charges for Nucraft products are prepaid for standard delivery in the continental United States. Standard delivery is defined as follows: Product is delivered on a 53' trailer being pulled by a long-haul tractor (total length of 85'). Facility will receive delivery Monday through Friday between the hours of 8:00 AM and 4:00 PM. Facility has docks with levelers and a fork truck for unloading. Product will be loaded on load bars two levels high. Receiving facility is responsible to have personnel on hand to unload the truck upon arrival, drivers do not unload. Delivery sites or times that do not meet this criteria will be accommodated, but will typically incur a charge to cover additional shipping costs. Please notify Nucraft in advance of the shipment if this is the case and the additional charge (if any) will be determined by Nucraft.

Product ships FOB dock. The customer obtains title to their product and materials, and assumes the risk of loss for them, upon shipment from Nucraft's facilities.

## Storage

Nucraft has no storage facilities for finished product. If a customer cannot accept an order when it is ready for shipment, the customer must designate an alternative shipping address. If no address is provided, Nucraft may, at its discretion, transfer the product to storage. If product is transferred to an off-site storage facility, the customer may be charged for transportation to the facility and for any associated storage fees. Nucraft considers transfer of the product to a storage facility the equivalent of shipment, including invoicing and payment. Customers assume the risk of damage or loss during storage.

## Transportation Times and Delays

Third party carriers that Nucraft contracts with will make reasonable efforts to accommodate requested delivery times and dates. Scheduled delivery appointments may, however, be delayed for a variety of reasons, including inclement weather, traffic, transportation equipment problems, and delays encountered at other delivery locations along the delivery route. Nucraft does not recommend scheduling activities that depend on the delivery appointment (for example, scheduling furniture installers to install furniture the day of the delivery appointment). Nucraft shall not be liable for any costs incurred as a result of a missed delivery appointment.

## Shipment Damage Claims

Legal title to merchandise passes to the buyer upon acceptance by the carrier. **Inspect all cartons upon delivery.** Details of visible damage should be noted on the delivery receipt. Do not install product if damage is found upon inspection. The carrier should be notified by the buyer to inspect the merchandise, and file a claim immediately. If visible damage is not apparent, sign the delivery receipt "No visible damage." This will allow recourse for a concealed damage claim. Although most claims for transportation damages must be filed against the carrier within nine months of the date of delivery, concealed damage claims must be filed within 15 days of receipt.

Do not destroy packing materials until shipment has been inspected. Then proceed to file a claim with the carrier.

**Failure to make any claims against Nucraft within 10 days shall constitute acceptance of the merchandise and a waiver of any defects, errors or shortages discovered upon inspection.**

## Cancellations

Cancellations must be reviewed by our Customer Service team. Because we build your products to order, orders cannot be cancelled once processing has begun. Processing includes but is not limited to development of shop drawings and other engineering drawings. If cancellation is approved, a processing fee of 20-100% will be assessed based on the status of the order.

## Change Order Policy

Nucraft will make every attempt to honor any reasonable change request to product provided that the request is received prior to start of production. Change orders will be accepted only if the request is made in writing and received in time to make the change. Nucraft reserves the right to increase our acknowledged price and ship date if necessary to make the requested changes. Please submit any change order request to our Customer Service team. Nucraft will assess charges to the customer as stipulated in the following:

- Standard Orders: Change orders received prior to production will be charged \$400 net to cover administrative costs.
- Special Orders: Change orders received prior to production will be charged \$400 net to cover administrative costs. There may be additional costs associated with engineering labor required for the change order.
- Change orders received after production must be evaluated by Nucraft. If approved, the charge will be \$400 net plus any restocking charges accumulated. There may be additional costs associated with engineering and/or manufacturing labor, as well as material costs, required for the change order.



# GENERAL INFORMATION

## Repair Authorization

Prior written approval is required for repairs of merchandise charged to NuCraft. Failure to do so will result in customer funded repairs.

## Payment Terms

Deposits are required at the time of order due to the custom nature of our products. See information regarding Cancellations above.

Credit terms are available to qualified customers. Please contact AR@NuCraft.com to start the application process. Note that the credit application process requires a valid sales tax exemption or resale tax certificate, Form W-9, and three current trade references.

Credit Card Payments are accepted via web portal. Please contact AR@NuCraft.com for payment instructions. Note that a 2% convenience fee will be added for using this payment method and no early pay discounts are allowed on credit card payments.

## Warranty

NuCraft Furniture is warranted to be free from defects in materials and workmanship for a period of ten years of single shift use. Limitations include:

- Mechanical Devices such as latches, casters, and other moving components are warranted for five years of the date of original delivery.
- Height adjustable components are warranted for two years of the date of original delivery.
- The following are warranted for one year of the date of original delivery:
  - Textiles
  - Electrical Components
  - Refrigeration Units
  - Custom Products not described in NuCraft's Catalogue

This warranty is applicable only if furniture is properly installed and maintained in an office environment. This warranty extends only to products manufactured and sold in North America and only to original purchasers acquiring new NuCraft product through authorized dealers or approved sellers.

During this warranty period, NuCraft's sole obligation is to repair or replace, at NuCraft's discretion, products which prove to be defective during the warranty period.

This warranty does not cover:

- Damage caused by a carrier.
- Damage from user modification, misuse, abuse, accident, or negligence.
- Customer's Own Material (COM) specified by the customer that is not a standard product offering.
- Color, grain, or texture of wood and other covering material.

**NuCraft extends no other warranties, expressed or implied, including warranty of merchantability or fitness for a particular purpose. NuCraft shall not be liable for loss of time, inconvenience, commercial loss, incidental or consequential damages.**

## Environmental Statement

NuCraft is committed to supporting responsible environmental policies and practices in all that we do. We strive for sustainability, weighing our business decisions against the costs to the ecological, social and economic systems they affect.

Our products are manufactured to meet the credit requirements of the U.S. Green Building Council's LEED rating systems in one or more of the following categories:

- Recycled Content
- Certified Wood
- Low-Emitting Materials

## Computer Aided Planning

NuCraft products and pricing are available on CD via 2020 Cap, an AutoCAD®-based space planning tool.

2020 Cap is an integrated software system developed specifically for interior designers and facility planners to enhance workplace performance. This modern suite of applications works together seamlessly, in concert. Navigate catalogs, select products, design in plan view and 3D, assign options, create worksheets and build a project where you want, when you want. Take your pick. It's dynamic and interactive. Design projects are a work in progress. And now you can perform any of the many discrete tasks that go into a project any time, any place.

For additional information, you may contact 2020 Cap direct at 800-227-0038.

## iSpec®

NuCraft offers a free online product configuration and specification service that saves you time and allows you to be creative while leaving the nuts and bolts to someone else. No specific software is required, nor is there any learning curve. This service applies to all NuCraft products. For additional information, call 1-877-NUCRAFT and ask for the iSpec Team or log on to [www.nucraft.com/ispec](http://www.nucraft.com/ispec).



# FINISH INFORMATION

## Surface Materials Palette

We crafted our materials palette using the same demanding standards that distinguish our furniture. Thoughtful design and attention to every detail elevate your possibilities.

Anchored by NuCraft veneers, unrivaled for clarity, quality, and depth of finish, our collection of surface materials comprises a sophisticated set of balanced elements that supports your design vision.

Some elements have their roots in NuCraft’s rich heritage. Others are new materials and reflect current trends and taste. Together, they ensure that you’re ready for today and positioned well for the future. Beautifully.

## Custom Finishes

NuCraft specializes in expert custom finish matching. For a nominal upcharge we can provide custom finishes, and we are frequently asked to match the finishes of other furniture manufacturers. For finishes that appear unusual to match or for customers directly requesting a sample, a finish sample will be sent for approval prior to entering the order.

Custom finishes requiring colored varnishes to create a painted look can only be applied to Maple veneer and require one extra week in addition to the standard lead time. NuCraft’s standard black finish (G82) can be applied to all NuCraft standard veneers. Walnut is the standard black veneer. Other species must be specified when ordering.

Clear coat on a special veneer requires an approved sample.

Custom finishes carry a 10% upcharge per item, per finish, capped at \$1,975 List.

Custom finish upcharges are not applied to any item that is not wood. Example: casters, ganging connectors, power options..

## Treatments

**Note: Default veneer sheen will vary per finish and product. Default finish is bolded on pages vi-vii. If no direction is provided on incoming orders, default sheen will be selected. In addition, default veneer cut is noted in the price list. If no direction is provided on incoming orders, default cut will be selected.**

**Gloss:** Gloss is a durable finish that tends to nicely mask normal wear and leaves wood grain visible to the eye. It achieves a medium gloss open pore appearance (40 – 50 sheen range). Finish numbers preceded by the letter “G” indicate a Gloss finish.

**Matte:** Like Gloss, Matte is durable, tends to nicely mask normal wear and leaves wood grain visible to the eye. It achieves a low luster, open pore appearance (10 – 20 sheen range). Finish numbers preceded by the letter “M” indicate a Matte finish.

Since each veneer type responds differently to both types of treatment, all will have a distinctive look and feel when finished. For example, a Walnut veneer with a Gloss treatment will remain much more textured than a Cherry veneer with the same treatment.

## About the Wood

All NuCraft veneers are carefully selected for uniformity of color and grain. Still, wood is a natural substance and minor variations may occur due to its own uniqueness. Because of this, the furniture you receive may not be an exact match to our samples.

NuCraft takes great pride in our finish color consistency. However, wood is a natural product that will have color variation within a single piece of furniture, as well as from one piece to the next. Other factors also affect color over time, such as exposure to light (both intensity and duration). For example, lighter finishes cause more variation in colors over time.

In cases where a returning customer wants a precise match with existing furniture, we recommend sending a sample of the existing furniture finish. Please contact NuCraft Customer Service to determine an appropriate sample. This will ensure a finish match between old and new orders. This type of order is considered a control sample. There will be a 10% upcharge on an order of this type. Due to natural aging of veneers, natural finishes may vary.

## Care and Maintenance of Wood Finishes

Our finish material is a crystal clear, urethane acrylic blend. This type of finish may be repaired in the field by a qualified refinisher.

NuCraft recommends using a damp cloth to clean your fine wood furniture. Always wipe with the grain of the wood. Should your wood furniture require a more thorough cleaning, we recommend using a mild cleaner such as Joy dish soap or Murphy’s oil soap, thoroughly diluted in water (one part soap to thirty parts water). Water will not damage NuCraft’s finish, but it may leave surface spots when it dries. To avoid this, dry the surface with a soft cloth after it is cleaned. Marks that cannot be removed with the cleaning methods above may be able to be removed using naphtha, a mild degreasing solvent.

Caution: while the use of polishes that contain wax, petroleum solvents or silicones may immediately enhance the “shine” of a product, it may also eventually remove the fine original finish applied in our factory. Silicone on the surface of wood may also make it very difficult to respray or refinish.

All NuCraft furniture is inspected and polished before it leaves our factory. In some instances, the packing materials may imprint on the factory polish. Cleaning and polishing the furniture once it is unpacked will normally restore the furniture to its original beauty.

In some cases, the rubber support feet used on the bottom of common office equipment (teleconferencing phones, laptops, microphones, copiers, etc.) can create unsightly marks in the surface of wood tops, due to oxidation of the lacquer finish. We suggest these machines be placed on a protective type of padding, such as felt.

Wood will fade as a result of exposure to UV light. This is particularly prevalent with light finishes. If color changes due to fading are a concern for your application, the impact can be minimized by selecting medium to dark stains for your wood surfaces. Our top coat includes a UV inhibitor which makes the finishes less prone to fading.



# FINISH INFORMATION

## Laminates

Selected Formica® and Nevamar® laminates are available on Training Tables, Conference Tables, Conference Room Furniture and select Occasional Tables. For standard laminate and wood pricing, refer to individual item pricing columns.

## Non-Standard Laminates and Linoleums

To order a color other than those on our list (see pages vi-vii), refer to Nevamar or Formica standard grade, matte texture laminate offerings and Forbo Furniture Linoleums (excluding manufacturers' non-standard matte offering).

- For approved non-standard laminates with a hardwood edge, the upcharge is 10% of the base price per laminate color with a minimum of \$500 and capped at \$1975.
- For approved non-standard laminate with a standard ABS edge, the upcharge is \$175 per laminate color.
- For approved non-standard laminates with a non standard ABS edge, please contact customer service.

To ensure your non standard laminate is on our approved list, please contact customer service. Add one week to the lead-time for all non-standard laminate and linoleum orders. Call the Nucraft Customer Service team for quotes on premium grades and laminates. Mirror and metal laminates are not available.

## Care and Maintenance of Laminate and Novawrap

Laminate and Novawrap surfaces may be cleaned with a damp cloth and ordinary soap or non-abrasive household liquid detergent. Dry the surface with a clean cloth or soft paper towel to prevent streaks from appearing.

## Care and Maintenance of Metal

Metal surfaces can be wiped with a damp cloth and rubbed dry. A mild non-abrasive household liquid detergent can be used if necessary. Regular maintenance of metal components, including tightening of fasteners and light lubrication of moving parts, will extend the life of your furniture.

## Satin Etched Glass

Glass color may vary slightly on multi-piece conference table tops over 180" x 60" when satin etched glass is specified due to the iron content and etching process of the glass.

## Care and Maintenance of Glass

Clear or frosted glass may be cleaned with commercial glass cleaner. Be sure to use a lint-free cloth if cleaning the frosted side of the glass.

## Stone and Solid Surface Material

Despite its reputation for durability, natural stone can easily be broken during handling and/or installation if proper techniques are not followed. In addition, Nucraft is not responsible for the installation of natural stone or solid surface materials on its products. Therefore, installers specifically trained in the installation of these materials must be utilized to ensure a quality installation. Nucraft shall not be liable for any damages incurred during the handling and/or installation of natural stone or solid surface materials on its products.

## Care and Maintenance of Granite

Granite surfaces may be cleaned with a damp cloth and ordinary soap or non-abrasive household liquid detergent. Dry the surface with a clean cloth or soft paper towel to prevent streaks from appearing.

## Care and Maintenance of Leather

Genuine leather requires very little care. Nucraft recommends that leather be dusted regularly. If a more thorough cleaning is needed, use lukewarm water and a mild, non-abrasive soap. Generate some lather and lightly rub the surface with cheesecloth. Rinse off any soap film with clean water and towel dry. The leather may dry dull. To restore the leather to a normal gloss, rub it with a clean towel. Never use furniture polish, oil, varnish or ammonia. Saddle soap may be used to prevent the leather from becoming brittle or cracked and to maintain the original supple finish.

## Touch Up Finish Kits

Model #	Description	Price
KIT-M	Metal Kit	80
KIT-P	Paint Kit	80
KIT-S	Stain Kit	80

### REQUIRED INFORMATION: (ORDER CANNOT BE ENTERED WITHOUT THIS INFORMATION)

- Kit model number
- Quantity of kits
- Specify finish (See pages vi-vii)

### General Information:

- Touch-up kits must be ordered on a purchase order separate from Nucraft product due to Hazmat shipping



## WOOD FINISHES

### STANDARD

Default veneer sheen will vary per finish and were determined by a team of experts who reviewed the colorways to determine if gloss or matte best highlighted the natural characteristics of the species of wood and the color of the stain. Default finish is bolded. If no direction is provided, default sheen will be selected.

	Matte	Gloss
<b>Ash</b>		
Blanco	<b>M44</b>	G44
Char	<b>M50</b>	G50
<b>Rift Cut Oak</b>		
Carbon	M03	<b>G03</b>
<b>Flat Cut Oak</b>		
Dune	<b>M05</b>	G05
Portobello	<b>M7413</b>	G7413
<b>Flaky Oak</b>		
Sahara	<b>M61</b>	G61
<b>Cherry</b>		
Cognac	M21	<b>G21</b>
Auburn	M93	<b>G93</b>
<b>Walnut</b>		
Marron	<b>M35</b>	G35
Mocha	<b>M33</b>	G33
Zinc	M30	<b>G30</b>
Onyx	M82	<b>G82</b>
Otter	M31	<b>G31</b>
<b>Maple</b>		
Natural Maple	M60	<b>G60</b>
<b>Linea</b>		
Oak Linea	<b>M08</b>	G08
Walnut Linea	<b>M27</b>	G27
Euro Birch Linea	<b>M09</b>	G09
Silver Birch Linea	M10	<b>G10</b>
<b>Paldao</b>		
Thicket	<b>M75</b>	G75
Paldao	<b>M76</b>	G76
Canyon	M77	<b>G77</b>

### PLANK

Plank offers dramatic variations in veneer leaf color, length, and natural characteristics; it simulates randomly matched veneers

	Matte	Gloss
<b>Plank Walnut</b>		
Clear Coat	M38	<b>G38</b>

## METAL FINISHES

### Powder Coat

Aged Bronze	A8010
Black	A44
Burnished	A8009
Cloud	A8004
Foil	A8006
Galaxy	A8007
Satin Bronze	A8011
Shadow	A8005
Storm	A8012

### Metal

Clear Anodized	CA
Polished Chrome*	PC

\*Up-Charge applies.

## PAINTS

Aged Bronze	S8010
Black	S44
Burnished	S88
Cloud	S8004
Foil	S8006
Galaxy	S8007
Moonlight	S87
Satin Bronze	S8011
Shadow	S8005
Storm	S8012

### Paint to Match

To request a custom paint color, contact Nucraft Customer Service. A paint sample must be matched and approved prior to order.



## STONE TOPS

Stone orders may affect lead times. Please contact Nucraft Customer Service for details.

		<b>Subtop Paint Color</b>
<b>Quartz   Cambria® Signature</b>		
Ainsley	STC100	S8004
Armitage	STC101	S44
Bellingham	STC102	S8004
Berkeley	STC103	S8004
Berwyn	STC104	S8004
Blackbrook	STC105	S44
Bradshaw	STC106	S8004
Bradwell	STC107	S8004
Cambria Black	STC109	S44
Carrick	STC110	S44
Clifton	STC112	S8004
Colton	STC113	S8004
Crowndale	STC114	S8004
Devon	STC115	S44
Fairbourne	STC116	S8004
Fieldstone	STC117	S44
Halewood	STC119	S8004
Hermitage	STC120	S8004
Highgate	STC121	S8004
Kendal	STC122	S8004
Laneshaw	STC124	S44
Malvern	STC125	S8004
Montgomery	STC128	S8004
Nevern	STC129	S8004
New Quay	STC130	S8004
Pendle Hill	STC131	S8004
Praa Sands	STC132	S8004
Rose Bay	STC133	S8004
Sandgate	STC135	S8004
Smithfield	STC136	S8004
Summerhill	STC137	S8004
Sutherland	STC138	S8004
Swanbridge	STC139	S8004
Torquay	STC140	S8004
Travella	STC141	S8004
Weybourne	STC143	S8004
Whitney	STC144	S8004
Woodcroft	STC146	S44

## Quartz | Cambria® Luxury

Abbey	STC147	S8004
Annicca	STC148	S8004
Baybridge	STC149	S8004
Beckington	STC150	S8004
Bentley	STC151	S8004
Blackpool Matte	STC152	S44
Brittanicca	STC153	S8004
Brittanicca Gold Cool	STC154	S8004
Brittanicca Gold Warm	STC155	S8004
Brittanicca Warm	STC156	S8004
Clovelly	STC158	S8004
Delamere	STC159	S44
Delgatie	STC160	S8004
Ella	STC161	S8004
Everleigh	STC162	S8004
Gladstone	STC163	S8004
Golden Dragon	STC164	S44
Hailey	STC165	S8004
Harlow	STC166	S8004
Hemsworth	STC167	S8004
Huntley	STC168	S8004
Inverness Bristol Bay	STC169	S8004
Inverness Bronze	STC170	S8004
Inverness Cobalt	STC171	S8004
Inverness Everleigh	STC172	S8004
Inverness Platinum	STC173	S8004
Inverness Swansea	STC174	S8004
Ironsbridge	STC175	S8004
Iverness Frost	STC176	S8004
Iverness Gold	STC177	S8004
Ivybridge	STC178	S8004
Lakedale	STC179	S8004
Mayfair	STC181	S8004
Mersey	STC182	S44
Notting Hill	STC183	S8004
Oakleigh	STC184	S8004
Portrush	STC185	S8004
Queen Anne	STC186	S8006
Skara Brae	STC187	S8004
Southport	STC188	S8004
White Cliff	STC189	S8004

## Quartz | Wilsonart

Carrara Codena	ST21	S8004
Serene	ST17	S8004

## Stone

Absolute Black Honed Granite	ST01	S8007
Carrara Marble	ST16	S8004





## SOLID SURFACE TOPS

Available on round tables and credenza tops only

Wilsonart Designer White ST11

## GLASS (SATIN OR GLOSS)

	Satin	Gloss
Black	BS	-
Clove	VS	VG
Meringue	MS	MG
Quill	QS	QG
White	WS	WG

Note: Due to color variation inherent in the natural acid etching process, Satin Etched Glass is not available on tables longer than 180" or wider than 60"

## LAMINATES

Wood Grain Laminates <sup>§</sup>	Code	Coordinating Wood Finish	Coordinating Woodgrain Edgeband
Formica White Ash	8841-58	M8841	R8841
Formica Natural Ash	8843-58	M8843	R8843
Formica Aged Ash	8844-58	M8844	R8844
Formica Weathered Ash	8842-58	M8842	R8842
Formica Oiled Legno	8846-58	M8846	R8846
Formica Bleached Legno	8845-58	M8845	R8845
Formica Blackened Legno	8848-58	M8848	R8848
Formica Urban Planked Oak	9312-58	M9312	R9312
Formica Thermo Walnut	6402-58	M6402	R6402
Formica Smoky Brown Pear	5488-58	M5488	R5488
Formica Espresso Pear	5489-58	M5489	R5489
Formica White Knotty Maple	7410-58	M7410	R7410
Formica Sand Maple	9237-58	G60	W7909
Formica Planked Coffee Oak	7413-58	M7413	F7413

<sup>§</sup>Not available on multiple piece conference tables

### Wood Grain Laminates Suitable for Multiple Piece Conference Tables

Formica Pecan Woodline	5883-58	M5883	R5883
Formica Chestnut Woodline	5884-58	M5884	R5884

### Solid Laminates

Formica Brite White	459-58	R01
Formica Dover White	7197-58	R01
Formica Pearl	934-58	R02
Formica Graystone	464-58	R02
Formica Folkstone	927-58	R03
Formica Graphite	837-58	R05

### Patterned Laminates

Nevamar Cool Chic	VA7002T	R02
Nevamar Serene Stardom	VA5001T	R05
Nevamar Calm Distinction	VA6001T	R05
Nevamar Easy Elegance	VA5002T	R05
Wilsonart Sheer Mesh	4876-38	R02
Wilsonart Grey Mesh	4877-38	R02
Wilsonart Pewter Mesh	4878-38	R05

## ABS FINISHES

Ashen	R04
Parchment	R02
Shale	R05
Stone	R03
Whitecap	R01