

# FLOW™ CREDENZA

## Planning Guide + Price List

---

### QUICK LINKS

[PLANNING GUIDE](#)

[FLOW CREDENZA PRICING](#)

[GENERAL INFORMATION](#)

[FINISH INFORMATION](#)

[SURFACE MATERIALS](#)



# TABLE OF CONTENTS

Click the shortcuts below to jump to each section.

General Information	ii-iii
Finish Information	iv-v
Surface Materials	vi-viii

Statement of Line	3
Specification Overview	4

## FLOW CREDENZA

Exterior Components	5
Interior Components	6
Base Styles	7
Door Styles	8
Dimensions	9
Price List	10-79
Veneer Top with Hardwood Edge	10-19
Laminate Top with Hardwood Edge	20-29
Laminate Top with ABS Edge	30-39
Gloss Glass Top	40-49
Satin Glass Top	50-59
Stone Top	60-69
Solid Surface Top	70-79

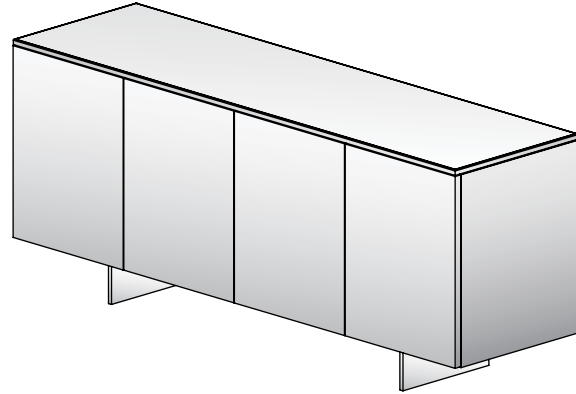



# STATEMENT OF LINE

## CASE STYLE

---

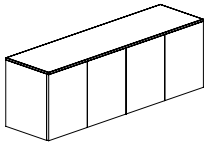

Conference Height

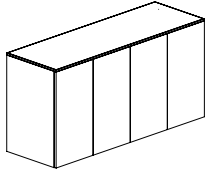

Buffet Height

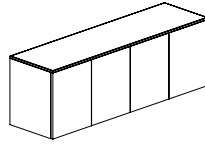

Low Height

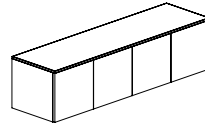

Wall-Hung

## BASE STYLE

---

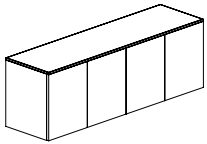

Case Only

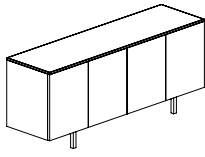

Inset Leg

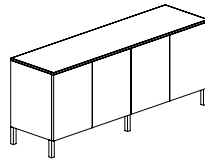

Edge-mount Leg

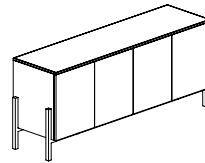

Cradle

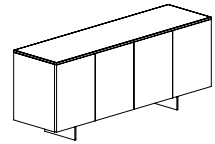

Blade



# SPECIFICATION OVERVIEW

---

## FLOW CREDENZA

### 1. Select Top Material

Choose from veneer, stone, glass, solid-surface, or laminate.

### 2. Select Base Style

Choose case only, or one of four base styles: inset, edge-mount, cradle, or blade. All base styles are available in powder coat or polished metal.

### 3. Select Case Material

Choose laminate, painted, or veneer. All standard laminates and veneers are available as well as a variety of paint options.

### 4. Select Case Size

First pick the credenza height: wall-hung, low, conference, or buffet. Then choose the number of doors: 2, 3, 4, or 5.

### 5. Select Door Style

Pick a design: vertical veneer, horizontal, and plank veneer styles, or painted and veneer door front combinations.

### 6. Select Options

- Locks
- A cutout and thermostatically-controlled fan can be added to the back panel for cable management and to remove heat generated by enclosed equipment
- Additional components:
  - One pull-out drawer behind each door
  - Front-opening single or double waste bin system
  - Sliding or fixed equipment racks





# EXTERIOR COMPONENTS

## TOP MATERIALS AND EDGE PROFILES

- Veneer tops are 3/4"-thick with a 3/16"-deep hardwood square edge band
- Laminate tops with a hardwood edge are 3/4"-thick with a 3/16"-deep edge band
- Laminate tops are 3/4"-thick with a 2 mm ABS edge
- Glass is 1/4"-thick back-painted, low-iron glass
- Stone tops are 2 cm thick
- Solid surface tops are 1/2"-thick

## DOOR STYLES

- Laminate door style will match laminate case finish. Vertical direction if woodgrain laminate is specified.
- Vertical veneer direction in a slip-match layup is available in all standard wood species and finishes
- Horizontal veneer direction is available in both slip-match and book-match layups dependent upon wood species
- Plank offers dramatic variations in veneer leaf color, length, and natural characteristics; it simulates randomly matched veneers
- Painted and veneer combinations

## BASE STYLES

- Case only selection includes a full-size case with .5" adjustable glides
- All metal post leg options are 1.25" square
  - Inset leg
  - Edge-mount leg, located just inside the case
  - Cradle base sits proud on each side
- The metal blade leg option is .5"-thick, inset, and runs the depth of the credenzas
- Finishes for all metal legs:
  - Powder coat
  - Polished

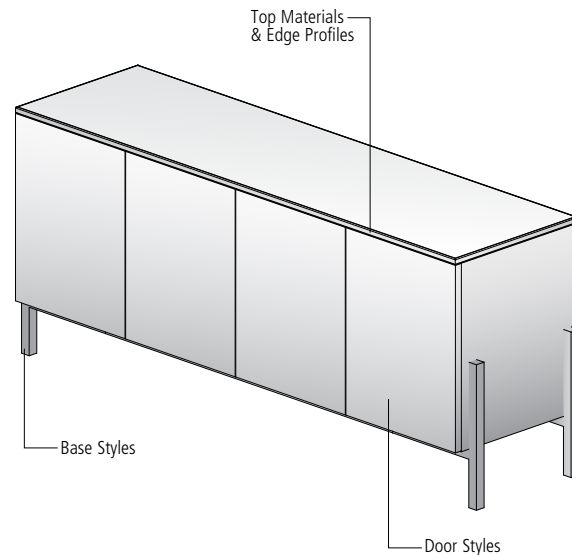

## VENTILATION AND CUTOUTS

Equipment racks include two cutouts:

- A 9"x9" cutout in the back panel is located behind the rack in the leftmost two-door cabinet
- A round cutout accommodates a thermostatically-controlled fan; that activates automatically at 87° F and turns off when the ambient temperature in the cabinet reaches 85° F; cables can also be routed into the case through the cutout in the back panel
- Available on all buffet height and case only conference height credenzas

### Ventilation & Cutouts

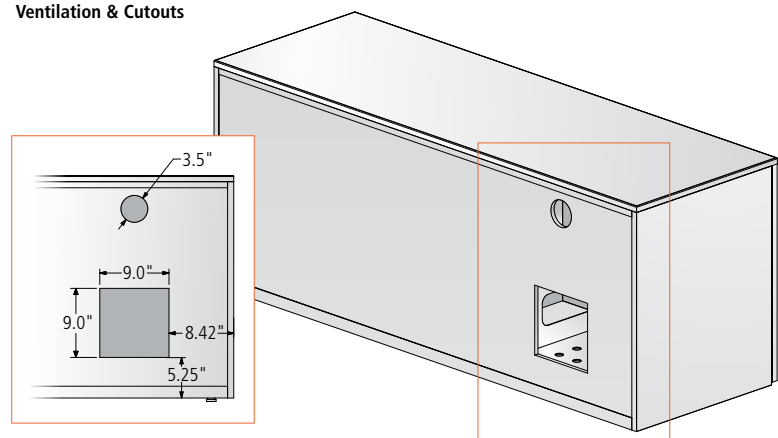



# INTERIOR COMPONENTS

## SHELF & DRAWER OPTIONS

- Adjustable shelves are standard
- One drawer behind each credenza door may also be specified on buffet height (case only) credenzas
  - Maple drawer box with applied front. Fronts to match case exterior.

Shelf and Drawer Options

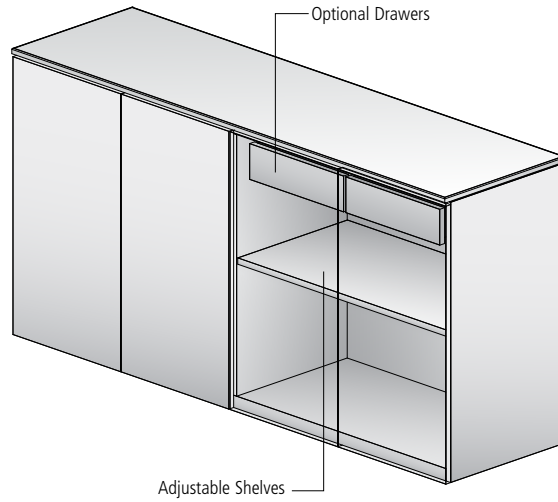

## WASTE AND RECYCLING

- A front-opening single waste bin system is available on 20"-deep credenzas
  - Bin Size: 14" x 10.5" x 18"; (1) 36 Qt.
- A front-opening double waste bin system is available on 24"-deep credenzas
  - Bin Size: 14" x 10.5" x 18"; (2) 36 Qt.
- Both options are offered on the low height (case only), conference height, or buffet height credenzas; located behind the rightmost door
- Shelf not included if Waste/Recycling unit specified

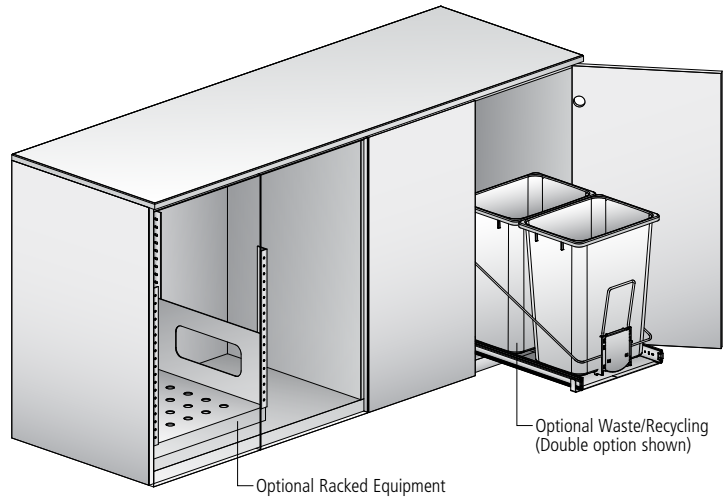

## RACKED EQUIPMENT

- Select from sliding or fixed equipment racks
- Equipment racks hold 12RU and include a thermostatically-controlled fan, plugstrip, and a 9"x9" cutout in the back panel behind the rack
- Available on all buffet height and case only conference height credenzas; located in the leftmost two-door cabinet

## COMPONENT DIMENSIONS:

Single Waste/Recycling

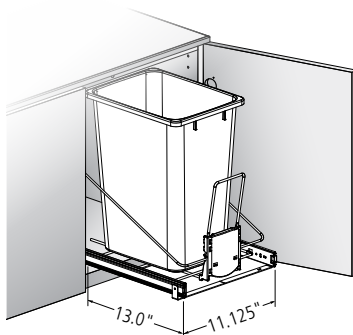

Double Waste/Recycling

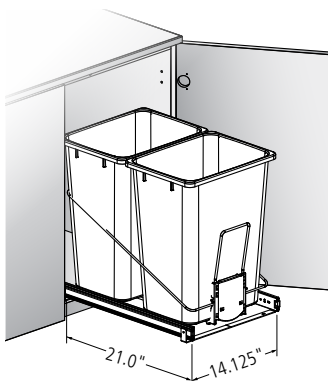

Drawers

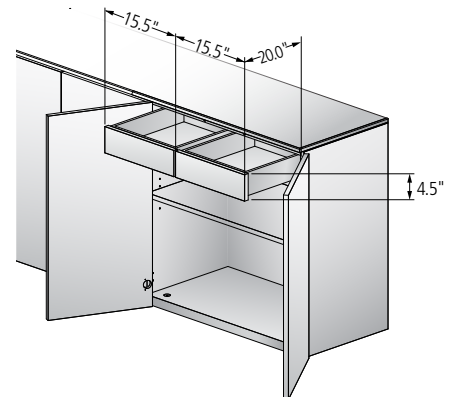



## BASE STYLES

### CASE

This selection includes a full-size case with adjustable glides.

### Case



### INSET LEG

Inset metal frame is 1.25" square and 6.5" in height; available in powder coat or polished finish.

### Inset Leg

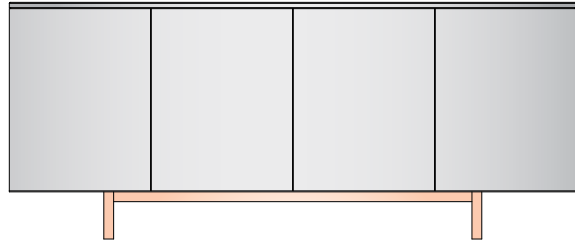

### EDGE-MOUNT POST LEG

The edgemount metal post leg is 1.25" square and 6.5" in height; available in powder coat or polished finish. Four post legs located on each corner for 36" – 54" wide credenzas. Two additional legs centered front and back for 72" – 90" wide credenzas.

### Edge-mount Post Leg

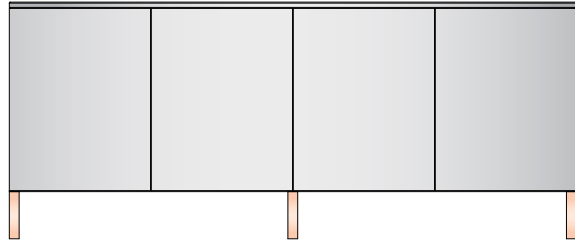

### CRADLE BASE

The cradle H-frame is 1.25" square and 6.5" in height; available in powder coat or polished finish. The metal frame runs 10.5" up on each side and runs the length of the credenza.

### Cradle Base

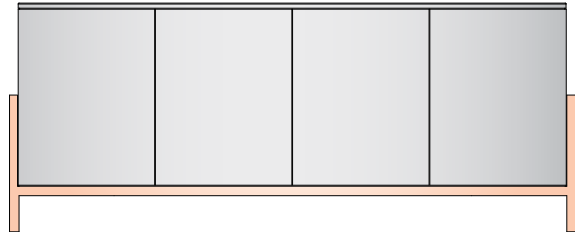

### BLADE BASE

The metal blade leg option is 1.5"-thick, 6.5" in height, and 14" in length, running the depth of the credenza. Available in powder coat or polished finish.

### Blade Base

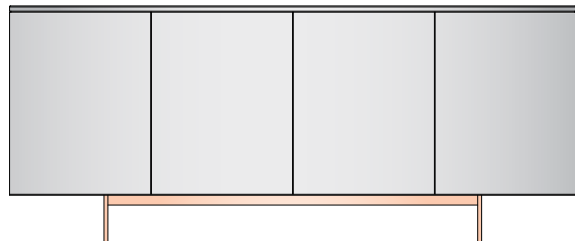



# DOOR STYLES

Veneer direction on door interior will be vertical. Veneer case will be vertical slip-match layup regardless of veneer door style selection. Veneer top will run the length of the case. Paint and laminate door interior will match door exterior. Laminate wood grain direction will be vertical on door and case. Case interior will match the case exterior. Laminate wood grain top will run the length of the case.

## Vertical Veneer and Woodgrain Laminates

Doors with a vertical veneer direction feature a slip-match layup and are available in all wood finishes.

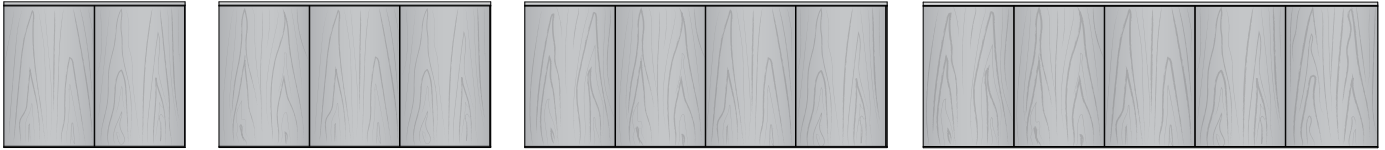

## Horizontal Veneer

Doors with a horizontal veneer direction are available in all wood species and finishes.

Book-match layup available in Ash, Cherry, and Walnut.

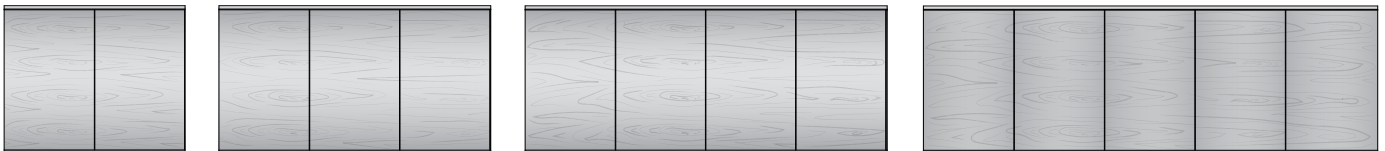

Slip-match layup available in Rift-Cut, Paldao, Linea, Quartered Figured Anigre, and Black Limba.



## Plank Veneer

Available in walnut, plank offers dramatic variations in veneer leaf color, length, and natural characteristics; simulates randomly matched veneers. Veneer top and case are flat-cut (non-plank) clear coat walnut and feature a vertical slip-match layup. Coordinating case finish captures color variation to complement the variation of the plank door style.

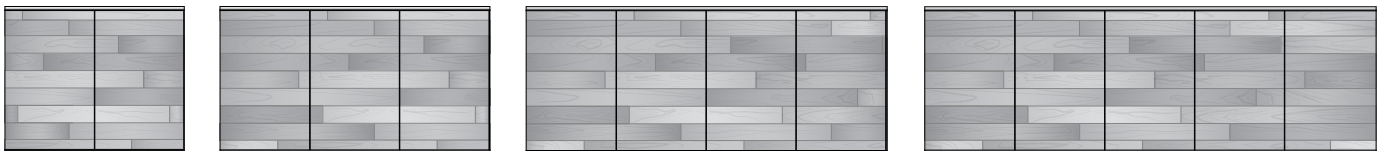

## Painted and Veneer Combinations

Available on all credenzas in any door or base style. If specified, a paint finish must be selected. Case interior will always match the finish of the case exterior.

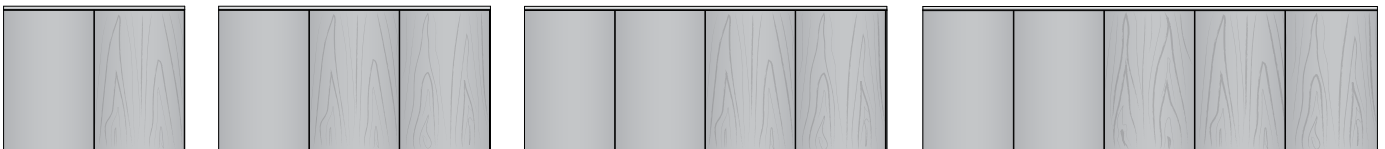



# DIMENSIONS

## DIMENSIONS

All Credenzas 54" and wider include vertical panels that divide the interior into two or three sections depending on credenza width. Dimensions A, B, and C reflect the width of each section. Exterior heights excludes top material thickness. Add top material for total height:

Veneer, Laminate and Stone - .75"

Glass - .25"

Solid Surface - .5"

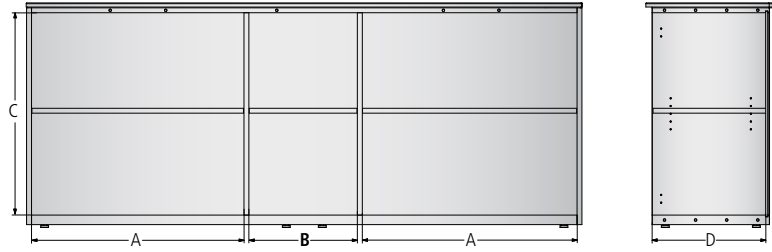

## WALL-HUNG



Interior Dimensions				
Exterior	A	B	C	D
36"W x 20"D x 17.2"H	34.4	-	14.75	18
54"W x 20"D x 17.2"H	34.4	17.2	14.75	18
72"W x 20"D x 17.2"H	34.4	34.4	14.75	18
90"W x 20"D x 17.2"H	34.4	17.6	14.75	18

## LOW HEIGHT CRENDENZA



Case Only; Interior Dimensions				
Exterior	A	B	C	D
36"W x 20"D x 23.7"H	34.4	-	20.8	18
54"W x 20"D x 23.7"H	34.4	17.2	20.8	18
72"W x 20"D x 23.7"H	34.4	34.4	20.8	18
90"W x 20"D x 23.7"H	34.4	17.6	20.8	18

Case Only; Interior Dimensions				
Exterior	A	B	C	D
36"W x 24"D x 23.7"H	34.4	-	20.8	22
54"W x 24"D x 23.7"H	34.4	17.2	20.8	22
72"W x 24"D x 23.7"H	34.4	34.4	20.8	22
90"W x 24"D x 23.7"H	34.4	17.6	20.8	22

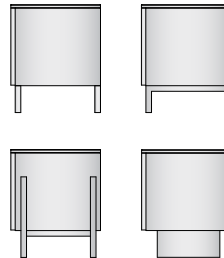

Metal Leg; Interior Dimensions				
Exterior	A	B	C	D
36"W x 20"D x 23.7"H	34.4	-	14.75	18
54"W x 20"D x 23.7"H	34.4	17.2	14.75	18
72"W x 20"D x 23.7"H	34.4	34.4	14.75	18
90"W x 20"D x 23.7"H	34.4	17.6	14.75	18

## CONFERENCE HEIGHT CRENDENZA



Case Only; Interior Dimensions				
Exterior	A	B	C	D
36"W x 20"D x 28.7"H	34.4	-	25.8	18
54"W x 20"D x 28.7"H	34.4	17.2	25.8	18
72"W x 20"D x 28.7"H	34.4	34.4	25.8	18
90"W x 20"D x 28.7"H	34.4	17.6	25.8	18

Case Only; Interior Dimensions				
Exterior	A	B	C	D
36"W x 24"D x 28.7"H	34.4	-	25.8	22
54"W x 24"D x 28.7"H	34.4	17.2	25.8	22
72"W x 24"D x 28.7"H	34.4	34.4	25.8	22
90"W x 24"D x 28.7"H	34.4	17.6	25.8	22

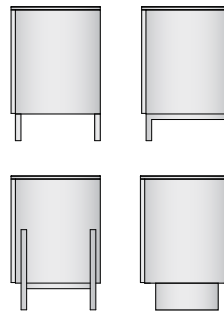

Metal Leg; Interior Dimensions				
Exterior	A	B	C	D
36"W x 20"D x 29.7"H	34.4	-	20.8	18
54"W x 20"D x 29.7"H	34.4	17.2	20.8	18
72"W x 20"D x 29.7"H	34.4	34.4	20.8	18
90"W x 20"D x 29.7"H	34.4	17.6	20.8	18

Metal Leg; Interior Dimensions				
Exterior	A	B	C	D
36"W x 24"D x 29.7"H	34.4	-	20.8	22
54"W x 24"D x 29.7"H	34.4	17.2	20.8	22
72"W x 24"D x 29.7"H	34.4	34.4	20.8	22
90"W x 24"D x 29.7"H	34.4	17.6	20.8	22

## BUFFET HEIGHT CRENDENZA



Case Only; Interior Dimensions				
Exterior	A	B	C*	D
36"W x 20"D x 35.7"H	34.4	-	32.8	18
54"W x 20"D x 35.7"H	34.4	17.2	32.8	18
72"W x 20"D x 35.7"H	34.4	34.4	32.8	18
90"W x 20"D x 35.7"H	34.4	17.6	32.8	18

Case Only; Interior Dimensions				
Exterior	A	B	C*	D
36"W x 24"D x 35.7"H	34.4	-	32.8	22
54"W x 24"D x 35.7"H	34.4	17.2	32.8	22
72"W x 24"D x 35.7"H	34.4	34.4	32.8	22
90"W x 24"D x 35.7"H	34.4	17.6	32.8	22

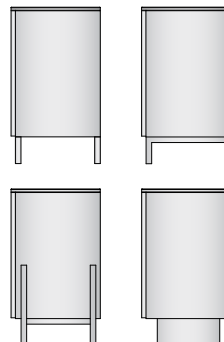

Metal Leg; Interior Dimensions				
Exterior	A	B	C	D
36"W x 20"D x 34.7"H	34.4	-	25.8	18
54"W x 20"D x 34.7"H	34.4	17.2	25.8	18
72"W x 20"D x 34.7"H	34.4	34.4	25.8	18
90"W x 20"D x 34.7"H	34.4	17.6	25.8	18

Metal Leg; Interior Dimensions				
Exterior	A	B	C	D
36"W x 24"D x 34.7"H	34.4	-	25.8	22
54"W x 24"D x 34.7"H	34.4	17.2	25.8	22
72"W x 24"D x 34.7"H	34.4	34.4	25.8	22
90"W x 24"D x 34.7"H	34.4	17.6	25.8	22

\*Subtract 6" from height if credenza includes drawer option.



# VENEER TOP WITH HARDWOOD EDGE

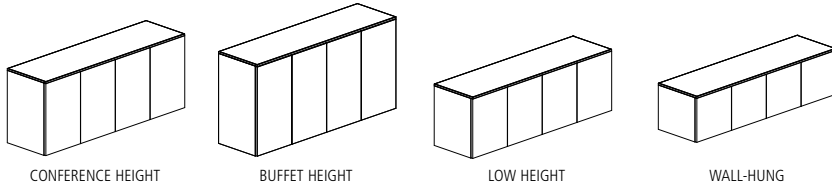

**CASE MATERIAL KEY**

PA Painted Case  
V Veneer Case

**CASE ONLY**

MODEL #	W x D x H	DESCRIPTION	-PA	-V
<b>CONFERENCE HEIGHT (29.5 INCH CASE)</b>				
FWCC-3629-W	36 x 20 x 29.5	Two Doors	5,469	5,785
FWCC-5429-W	54 x 20 x 29.5	Three Doors	7,118	7,532
FWCC-7229-W	72 x 20 x 29.5	Four Doors	8,769	9,280
FWCC-9029-W	90 x 20 x 29.5	Five Doors	10,421	11,027
FWCD-3629-W	36 x 24 x 29.5	Two Doors	6,013	6,361
FWCD-5429-W	54 x 24 x 29.5	Three Doors	7,829	8,284
FWCD-7229-W	72 x 24 x 29.5	Four Doors	9,648	10,208
FWCD-9029-W	90 x 24 x 29.5	Five Doors	11,461	12,127
<b>BUFFET HEIGHT (36.5 INCH CASE)</b>				
FWBC-3636-W	36 x 20 x 36.5	Two Doors	6,286	6,653
FWBC-5436-W	54 x 20 x 36.5	Three Doors	8,184	8,657
FWBC-7236-W	72 x 20 x 36.5	Four Doors	10,082	10,668
FWBC-9036-W	90 x 20 x 36.5	Five Doors	11,981	12,677
FWBD-3636-W	36 x 24 x 36.5	Two Doors	6,915	7,316
FWBD-5436-W	54 x 24 x 36.5	Three Doors	9,001	9,524
FWBD-7236-W	72 x 24 x 36.5	Four Doors	11,089	11,735
FWBD-9036-W	90 x 24 x 36.5	Five Doors	13,178	13,943
<b>LOW HEIGHT (24.5 INCH CASE)</b>				
FWLC-3624-W	36 x 20 x 24.5	Two Doors	5,064	5,358
FWLC-5424-W	54 x 20 x 24.5	Three Doors	6,592	6,977
FWLC-7224-W	72 x 20 x 24.5	Four Doors	8,121	8,592
FWLC-9024-W	90 x 20 x 24.5	Five Doors	9,650	10,211
FWLD-3624-W	36 x 24 x 24.5	Two Doors	5,570	5,891
FWLD-5424-W	54 x 24 x 24.5	Three Doors	7,250	7,674
FWLD-7224-W	72 x 24 x 24.5	Four Doors	8,931	9,452
FWLD-9024-W	90 x 24 x 24.5	Five Doors	10,613	11,227
<b>WALL-HUNG (18 INCH CASE)</b>				
FWWC-3618-W	36 x 20 x 18	Two Doors	4,648	4,919
FWWC-5418-W	54 x 20 x 18	Three Doors	6,053	6,403
FWWC-7218-W	72 x 20 x 18	Four Doors	7,455	7,886
FWWC-9018-W	90 x 20 x 18	Five Doors	8,858	9,371

**DOOR STYLE**

DESCRIPTION	CODE	NOTES	PRICE
Plank Veneer	-PWD	Available in Clear Coat Walnut	\$301
Vertical Veneer	-VD		No Charge
Horizontal Veneer	-HD		No Charge
Veneer/Paint Combination	-VPD	Reference page 8 for predetermined accent door locations	No Charge
Painted	-PAD		No Charge



# VENEER TOP WITH HARDWOOD EDGE

OPTIONS	CODE	PRICE	NOTES
Locks	Add <b>-LK</b>	\$301	
Drawers Behind Doors (Buffet Height - 36" Case Only)	Add <b>-D</b>	\$587	
<b>Equipment Rack Options - Conference Height and Buffet Height Credenzas:</b>			
Fixed Equipment Rack	Add <b>-R2</b>	\$906	Available for 24" deep Credenzas, behind the left most pair of doors
Sliding Equipment Rack	Add <b>-R1</b>	\$3,317	Available for 24" deep Credenzas, behind the left most pair of doors
<b>Waste/Recycling Unit Options:</b>			
Single Pull-Out Waste/Recycling Unit	Add <b>-TF1</b>	\$295	Available for 20" deep Credenzas only (Wall-Hung excluded), behind right most doors
Double Pull-Out Waste/Recycling Unit	Add <b>-TF2</b>	\$456	Available for 24" depth credenzas only (Wall-Hung excluded), behind right most doors

**REQUIRED INFORMATION (ORDER CANNOT BE ENTERED WITHOUT THIS INFORMATION):**

See pages vi-vii for surface material options.

- Choose Door Style: Defaults to case finish, if none selected
- Choose Wood Species & Finish
- Choose Paint Finish, if specified

**GENERAL INFORMATION**

- Tops are 3/4"-thick with 3/16"-deep hardwood edge band
- Plank veneer is hand selected walnut veneers of varying character and color, with a clear coat finish, to accentuate the plank appearance
- When Plank veneer door style is specified with a veneer case, case and top will default to clear coat walnut in standard slip-match layout
- When veneer case is specified, the case exterior is standard slip-match layout regardless of veneer door style selection
- Pull-Out Waste/Recycling Bin size: 14" x 10-1/2" x 18"; (1) 36 Qt.; Double Pull-Out Waste/Recycling Units include two bins
- Locks
  - Veneer (Case Only) - When lock option is specified, color will default to Satin Nickel
  - Painted (Case Only) - When lock option is specified, color will default based on Paint finish:
    - Aged Bronze, Black, Galaxy, Shadow, and Storm: Black
    - Cloud: White
    - Burnish, Foil, Satin Bronze: Satin Nickel
    - Chrome: Polished Nickel
- Credenzas include one adjustable shelf behind each door unless other components are specified
- Equipment racks hold 12RU and include a thermostatically controlled fan and plug strip



# VENEER TOP WITH HARDWOOD EDGE

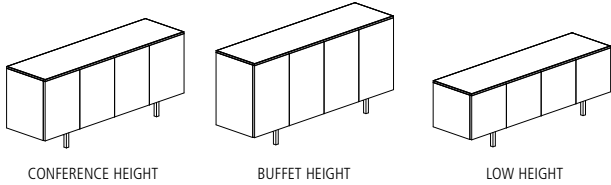

**CASE MATERIAL KEY**

PA-IB Painted Case with Inset Leg  
 V-IB Veneer Case with Inset Leg

**INSET LEG**

MODEL #	W x D x H	DESCRIPTION	-PA-IB	-V-IB
<b>CONFERENCE HEIGHT (24 IN. CASE WITH 6.5 IN. INSET LEG)</b>				
FWLC-3629-W	36 x 20 x 30.5	Two Doors	5,510	5,803
FWLC-5429-W	54 x 20 x 30.5	Three Doors	7,038	7,421
FWLC-7229-W	72 x 20 x 30.5	Four Doors	8,562	9,039
FWLC-9029-W	90 x 20 x 30.5	Five Doors	10,095	10,655
FWLD-3629-W	36 x 24 x 30.5	Two Doors	6,013	6,336
FWLD-5429-W	54 x 24 x 30.5	Three Doors	7,695	8,120
FWLD-7229-W	72 x 24 x 30.5	Four Doors	9,376	9,897
FWLD-9029-W	90 x 24 x 30.5	Five Doors	11,059	11,674
<b>BUFFET HEIGHT (29 IN. CASE WITH 6.5 IN. INSET LEG)</b>				
FWCC-3636-W	36 x 20 x 35.5	Two Doors	5,913	6,228
FWCC-5436-W	54 x 20 x 35.5	Three Doors	7,563	7,977
FWCC-7236-W	72 x 20 x 35.5	Four Doors	9,215	9,723
FWCC-9036-W	90 x 20 x 35.5	Five Doors	10,865	11,470
FWCD-3636-W	36 x 24 x 35.5	Two Doors	6,460	6,805
FWCD-5436-W	54 x 24 x 35.5	Three Doors	8,273	8,732
FWCD-7236-W	72 x 24 x 35.5	Four Doors	10,090	10,651
FWCD-9036-W	90 x 24 x 35.5	Five Doors	11,906	12,572
<b>LOW HEIGHT (18 IN. CASE WITH 6.5 IN. INSET LEG)</b>				
FWWC-3624-W	36 x 20 x 24.5	Two Doors	5,095	5,366
FWWC-5424-W	54 x 20 x 24.5	Three Doors	6,499	6,850
FWWC-7224-W	72 x 20 x 24.5	Four Doors	7,899	8,331
FWWC-9024-W	90 x 20 x 24.5	Five Doors	9,305	9,817

**DOOR STYLE**

DESCRIPTION	CODE	NOTES	PRICE
Plank Veneer	-PWD	Available in Clear Coat Walnut	\$301
Vertical Veneer	-VD		No Charge
Horizontal Veneer	-HD		No Charge
Veneer/Paint Combination	-VPD	Reference page 8 for predetermined accent door locations	No Charge
Painted	-PAD		No Charge

OPTIONS	CODE	PRICE	NOTES
Locks	Add <b>-LK</b>	\$301	
Polished Chrome Base	Add <b>-PCIB</b>	\$479	
<b>Equipment Rack Options - Buffet Height Credenzas:</b>			
Fixed Equipment Rack	Add <b>-R2</b>	\$906	Available for 24" deep Credenzas, behind the left most pair of doors
Sliding Equipment Rack	Add <b>-R1</b>	\$3,317	Available for 24" deep Credenzas, behind the left most pair of doors
<b>Waste/Recycling Unit Options:</b>			
Single Pull-Out Waste/Recycling Unit	Add <b>-TF1</b>	\$295	Available for 20" deep Credenzas only (Wall-Hung excluded), behind right most doors
Double Pull-Out Waste/Recycling Unit	Add <b>-TF2</b>	\$456	Available for 24" depth credenzas only (Wall-Hung excluded), behind right most doors





# VENEER TOP WITH HARDWOOD EDGE

**REQUIRED INFORMATION (ORDER CANNOT BE ENTERED WITHOUT THIS INFORMATION):**

See pages vi-vii for surface material options.

- Choose Door Style: Defaults to case finish, if none selected
- Choose Metal Finish
- Choose Wood Species & Finish
- Choose Paint Finish, if specified

**GENERAL INFORMATION**

- Tops are 3/4" -thick with 3/16" -deep hardwood edge band
- Plank veneer is hand selected walnut veneers of varying character and color, with a clear coat finish, to accentuate the plank appearance
- When Plank veneer door style is specified with a veneer case, case and top will default to clear coat walnut in standard slip-match layup
- When veneer case is specified, the case exterior is standard slip-match layup regardless of veneer door style selection
- Pull-Out Waste/Recycling Bin size: 14" x 10-1/2" x 18"; (1) 36 Qt.; Double Pull-Out Waste/Recycling Units include two bins
- When lock option is specified, color will default based on leg finish:
  - Aged Bronze, Black, Galaxy, Shadow, and Storm: Black
  - Cloud: White
  - Burnish, Foil, and Satin Bronze: Satin Nickel
  - Chrome: Polished Nickel
- Credenzas include one adjustable shelf behind each door unless other components are specified
- Equipment racks hold 12RU and include a thermostatically controlled fan and plug strip



# VENEER TOP WITH HARDWOOD EDGE

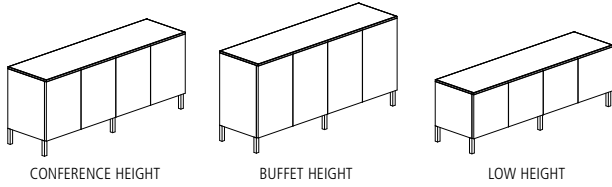

**CASE MATERIAL KEY**

PA-OB Painted Case with Edge-mount Post Leg  
 V-OB Veneer Case with Edge-mount Post Leg

**EDGE-MOUNT POST LEG**

MODEL #	W x D x H	DESCRIPTION	-PA-OB	-V-OB
<b>CONFERENCE HEIGHT (24 IN. CASE WITH 6.5 IN. EDGE-MOUNT POST LEG)</b>				
FWLC-3629-W	36 x 20 x 30.5	Two Doors	5,510	5,803
FWLC-5429-W	54 x 20 x 30.5	Three Doors	7,038	7,421
FWLC-7229-W	72 x 20 x 30.5	Four Doors	8,562	9,039
FWLC-9029-W	90 x 20 x 30.5	Five Doors	10,095	10,655
FWLD-3629-W	36 x 24 x 30.5	Two Doors	6,013	6,336
FWLD-5429-W	54 x 24 x 30.5	Three Doors	7,695	8,120
FWLD-7229-W	72 x 24 x 30.5	Four Doors	9,376	9,897
FWLD-9029-W	90 x 24 x 30.5	Five Doors	11,059	11,674
<b>BUFFET HEIGHT (29 IN. CASE WITH 6.5 IN. EDGE-MOUNT POST LEG)</b>				
FWCC-3636-W	36 x 20 x 35.5	Two Doors	5,913	6,228
FWCC-5436-W	54 x 20 x 35.5	Three Doors	7,563	7,977
FWCC-7236-W	72 x 20 x 35.5	Four Doors	9,215	9,723
FWCC-9036-W	90 x 20 x 35.5	Five Doors	10,865	11,470
FWCD-3636-W	36 x 24 x 35.5	Two Doors	6,460	6,805
FWCD-5436-W	54 x 24 x 35.5	Three Doors	8,273	8,732
FWCD-7236-W	72 x 24 x 35.5	Four Doors	10,090	10,651
FWCD-9036-W	90 x 24 x 35.5	Five Doors	11,906	12,572
<b>LOW HEIGHT (18 IN. CASE WITH 6.5 IN. EDGE-MOUNT POST LEG)</b>				
FWWC-3624-W	36 x 20 x 24.5	Two Doors	5,095	5,366
FWWC-5424-W	54 x 20 x 24.5	Three Doors	6,499	6,850
FWWC-7224-W	72 x 20 x 24.5	Four Doors	7,899	8,331
FWWC-9024-W	90 x 20 x 24.5	Five Doors	9,305	9,817

**DOOR STYLE**

DESCRIPTION	CODE	NOTES	PRICE
Plank Veneer	-PWD	Available in Clear Coat Walnut	\$301
Vertical Veneer	-VD		No Charge
Horizontal Veneer	-HD		No Charge
Veneer/Paint Combination	-VPD	Reference page 8 for predetermined accent door locations	No Charge
Painted	-PAD		No Charge

OPTIONS	CODE	PRICE	NOTES
Locks	Add <b>-LK</b>	\$301	
Polished Chrome Base	Add <b>-PCOB</b>	\$517	
<b>Equipment Rack Options - Buffet Height Credenzas:</b>			
Fixed Equipment Rack	Add <b>-R2</b>	\$906	Available for 24" deep Credenzas, behind the left most pair of doors
Sliding Equipment Rack	Add <b>-R1</b>	\$3,317	Available for 24" deep Credenzas, behind the left most pair of doors
<b>Waste/Recycling Unit Options:</b>			
Single Pull-Out Waste/Recycling Unit	Add <b>-TF1</b>	\$295	Available for 20" deep Credenzas only (Wall-Hung excluded), behind right most doors
Double Pull-Out Waste/Recycling Unit	Add <b>-TF2</b>	\$456	Available for 24" depth credenzas only (Wall-Hung excluded), behind right most doors



## VENEER TOP WITH HARDWOOD EDGE

**REQUIRED INFORMATION (ORDER CANNOT BE ENTERED WITHOUT THIS INFORMATION):**

See pages vi-vii for surface material options.

- Choose Door Style: Defaults to case finish, if none selected
- Choose Metal Finish
- Choose Wood Species & Finish
- Choose Paint Finish, if specified

**GENERAL INFORMATION**

- Tops are 3/4" -thick with 3/16" -deep hardwood edge band
- Plank veneer is hand selected walnut veneers of varying character and color, with a clear coat finish, to accentuate the plank appearance
- When Plank veneer door style is specified with a veneer case, case and top will default to clear coat walnut in standard slip-match layup
- When veneer case is specified, the case exterior is standard slip-match layup regardless of veneer door style selection
- Pull-Out Waste/Recycling Bin size: 14" x 10-1/2" x 18"; (1) 36 Qt.; Double Pull-Out Waste/Recycling Units include two bins
- When lock option is specified, color will default based on leg finish:
  - Aged Bronze, Black, Galaxy, Shadow, and Storm: Black
  - Cloud: White
  - Burnish, Foil, and Satin Bronze: Satin Nickel
  - Chrome: Polished Nickel
- Credenzas include one adjustable shelf behind each door unless other components are specified
- Equipment racks hold 12RU and include a thermostatically controlled fan and plug strip



# VENEER TOP WITH HARDWOOD EDGE

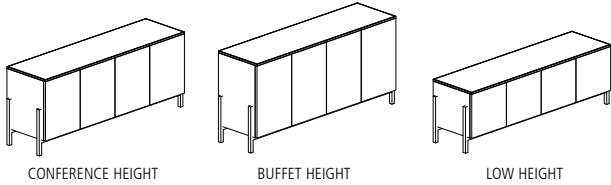

**CASE MATERIAL KEY**

PA-CB Painted Case with Cradle Base  
 V-CB Veneer Case with Cradle Base

**CRADLE BASE**

MODEL #	W x D x H	DESCRIPTION	-PA-CB	-V-CB
<b>CONFERENCE HEIGHT (24 IN. CASE WITH 6.5 IN. CRADLE BASE)</b>				
FWLC-3629-W	36 x 20 x 30.5	Two Doors	6,102	6,394
FWLC-5429-W	54 x 20 x 30.5	Three Doors	7,630	8,012
FWLC-7229-W	72 x 20 x 30.5	Four Doors	9,160	9,631
FWLC-9029-W	90 x 20 x 30.5	Five Doors	10,689	11,248
FWLD-3629-W	36 x 24 x 30.5	Two Doors	6,607	6,929
FWLD-5429-W	54 x 24 x 30.5	Three Doors	8,289	8,713
FWLD-7229-W	72 x 24 x 30.5	Four Doors	9,968	10,491
FWLD-9029-W	90 x 24 x 30.5	Five Doors	11,652	12,265
<b>BUFFET HEIGHT (29 IN. CASE WITH 6.5 IN. CRADLE BASE)</b>				
FWCC-3636-W	36 x 20 x 35.5	Two Doors	6,507	6,822
FWCC-5436-W	54 x 20 x 35.5	Three Doors	8,155	8,572
FWCC-7236-W	72 x 20 x 35.5	Four Doors	9,808	10,319
FWCC-9036-W	90 x 20 x 35.5	Five Doors	11,458	12,063
FWCD-3636-W	36 x 24 x 35.5	Two Doors	7,052	7,399
FWCD-5436-W	54 x 24 x 35.5	Three Doors	8,868	9,324
FWCD-7236-W	72 x 24 x 35.5	Four Doors	10,682	11,245
FWCD-9036-W	90 x 24 x 35.5	Five Doors	12,502	13,166
<b>LOW HEIGHT (18 IN. CASE WITH 6.5 IN. CRADLE BASE)</b>				
FWWC-3624-W	36 x 20 x 24.5	Two Doors	5,687	5,959
FWWC-5424-W	54 x 20 x 24.5	Three Doors	7,091	7,443
FWWC-7224-W	72 x 20 x 24.5	Four Doors	8,492	8,926
FWWC-9024-W	90 x 20 x 24.5	Five Doors	9,897	10,411

**DOOR STYLE**

DESCRIPTION	CODE	NOTES	PRICE
Plank Veneer	-PWD	Available in Clear Coat Walnut	\$301
Vertical Veneer	-VD		No Charge
Horizontal Veneer	-HD		No Charge
Veneer/Paint Combination	-VPD	Reference page 8 for predetermined accent door locations	No Charge
Painted	-PAD		No Charge

OPTIONS	CODE	PRICE	NOTES
Locks	Add <b>-LK</b>	\$301	
Polished Chrome Base	Add <b>-PCCB</b>	\$1,698	
<b>Equipment Rack Options - Buffet Height Credenzas:</b>			
Fixed Equipment Rack	Add <b>-R2</b>	\$906	Available for 24" deep Credenzas, behind the left most pair of doors
Sliding Equipment Rack	Add <b>-R1</b>	\$3,317	Available for 24" deep Credenzas, behind the left most pair of doors
<b>Waste/Recycling Unit Options:</b>			
Single Pull-Out Waste/Recycling Unit	Add <b>-TF1</b>	\$295	Available for 20" deep Credenzas only (Wall-Hung excluded), behind right most doors
Double Pull-Out Waste/Recycling Unit	Add <b>-TF2</b>	\$456	Available for 24" depth credenzas only (Wall-Hung excluded), behind right most doors



# VENEER TOP WITH HARDWOOD EDGE

**REQUIRED INFORMATION (ORDER CANNOT BE ENTERED WITHOUT THIS INFORMATION):**

See pages vi-vii for surface material options.

- Choose Door Style: Defaults to case finish, if none selected
- Choose Metal Finish
- Choose Wood Species & Finish
- Choose Paint Finish, if specified

**GENERAL INFORMATION**

- Tops are 3/4" -thick with 3/16" -deep hardwood edge band
- Plank veneer is hand selected walnut veneers of varying character and color, with a clear coat finish, to accentuate the plank appearance
- When Plank veneer door style is specified with a veneer case, case and top will default to clear coat walnut in standard slip-match layup
- When veneer case is specified, the case exterior is standard slip-match layup regardless of veneer door style selection
- Pull-Out Waste/Recycling Bin size: 14" x 10-1/2" x 18"; (1) 36 Qt.; Double Pull-Out Waste/Recycling Units include two bins
- When lock option is specified, color will default based on leg finish:
  - Aged Bronze, Black, Galaxy, Shadow, and Storm: Black
  - Cloud: White
  - Burnish, Foil, and Satin Bronze: Satin Nickel
  - Chrome: Polished Nickel
- Credenzas include one adjustable shelf behind each door unless other components are specified
- Equipment racks hold 12RU and include a thermostatically controlled fan and plug strip



# VENEER TOP WITH HARDWOOD EDGE

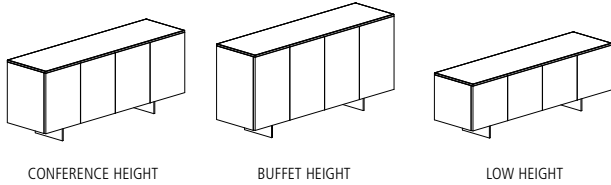

**CASE MATERIAL KEY**

PA-BB Painted Case with Blade Base  
 V-BB Veneer Case with Blade Base

**BLADE BASE**

MODEL #	W x D x H	DESCRIPTION	-PA-BB	-V-BB
<b>CONFERENCE HEIGHT (24 IN. CASE WITH 6.5 IN. BLADE BASE)</b>				
FWLC-3629-W	36 x 20 x 30.5	Two Doors	5,805	6,100
FWLC-5429-W	54 x 20 x 30.5	Three Doors	7,332	7,715
FWLC-7229-W	72 x 20 x 30.5	Four Doors	8,860	9,336
FWLC-9029-W	90 x 20 x 30.5	Five Doors	10,391	10,951
FWLD-3629-W	36 x 24 x 30.5	Two Doors	6,311	6,634
FWLD-5429-W	54 x 24 x 30.5	Three Doors	7,991	8,414
FWLD-7229-W	72 x 24 x 30.5	Four Doors	9,672	10,195
FWLD-9029-W	90 x 24 x 30.5	Five Doors	11,354	11,971
<b>BUFFET HEIGHT (29 IN. CASE WITH 6.5 IN. BLADE BASE)</b>				
FWCC-3636-W	36 x 20 x 35.5	Two Doors	6,211	6,526
FWCC-5436-W	54 x 20 x 35.5	Three Doors	7,860	8,273
FWCC-7236-W	72 x 20 x 35.5	Four Doors	9,513	10,020
FWCC-9036-W	90 x 20 x 35.5	Five Doors	11,162	11,767
FWCD-3636-W	36 x 24 x 35.5	Two Doors	6,757	7,103
FWCD-5436-W	54 x 24 x 35.5	Three Doors	8,572	9,027
FWCD-7236-W	72 x 24 x 35.5	Four Doors	10,388	10,948
FWCD-9036-W	90 x 24 x 35.5	Five Doors	12,205	12,869
<b>LOW HEIGHT (18 IN. CASE WITH 6.5 IN. BLADE BASE)</b>				
FWWC-3624-W	36 x 20 x 24.5	Two Doors	5,393	5,661
FWWC-5424-W	54 x 20 x 24.5	Three Doors	6,797	7,147
FWWC-7224-W	72 x 20 x 24.5	Four Doors	8,197	8,629
FWWC-9024-W	90 x 20 x 24.5	Five Doors	9,600	10,112

**DOOR STYLE**

DESCRIPTION	CODE	NOTES	PRICE
Plank Veneer	-PWD	Available in Clear Coat Walnut	\$301
Vertical Veneer	-VD		No Charge
Horizontal Veneer	-HD		No Charge
Veneer/Paint Combination	-VPD	Reference page 8 for predetermined accent door locations	No Charge
Painted	-PAD		No Charge

**OPTIONS**

OPTIONS	CODE	PRICE	NOTES
Locks	Add <b>-LK</b>	\$301	
Polished Chrome Base	Add <b>-PCBB</b>	\$479	
<b>Equipment Rack Options - Buffet Height Credenzas:</b>			
Fixed Equipment Rack	Add <b>-R2</b>	\$906	Available for 24" deep Credenzas, behind the left most pair of doors
Sliding Equipment Rack	Add <b>-R1</b>	\$3,317	Available for 24" deep Credenzas, behind the left most pair of doors
<b>Waste/Recycling Unit Options:</b>			
Single Pull-Out Waste/Recycling Unit	Add <b>-TF1</b>	\$295	Available for 20" deep Credenzas only (Wall-Hung excluded), behind right most doors
Double Pull-Out Waste/Recycling Unit	Add <b>-TF2</b>	\$456	Available for 24" depth credenzas only (Wall-Hung excluded), behind right most doors



# VENEER TOP WITH HARDWOOD EDGE

**REQUIRED INFORMATION (ORDER CANNOT BE ENTERED WITHOUT THIS INFORMATION):**

See pages vi-vii for surface material options.

- Choose Door Style: Defaults to case finish, if none selected
- Choose Metal Finish
- Choose Wood Species & Finish
- Choose Paint Finish, if specified

**GENERAL INFORMATION**

- Tops are 3/4" -thick with 3/16" -deep hardwood edge band
- Plank veneer is hand selected walnut veneers of varying character and color, with a clear coat finish, to accentuate the plank appearance
- When Plank veneer door style is specified with a veneer case, case and top will default to clear coat walnut in standard slip-match layup
- When veneer case is specified, the case exterior is standard slip-match layup regardless of veneer door style selection
- Pull-Out Waste/Recycling Bin size: 14" x 10-1/2" x 18"; (1) 36 Qt.; Double Pull-Out Waste/Recycling Units include two bins
- When lock option is specified, color will default based on leg finish:
  - Aged Bronze, Black, Galaxy, Shadow, and Storm: Black
  - Cloud: White
  - Burnish, Foil, and Satin Bronze: Satin Nickel
  - Chrome: Polished Nickel
- Credenzas include one adjustable shelf behind each door unless other components are specified
- Equipment racks hold 12RU and include a thermostatically controlled fan and plug strip



# LAMINATE TOP WITH HARDWOOD EDGE

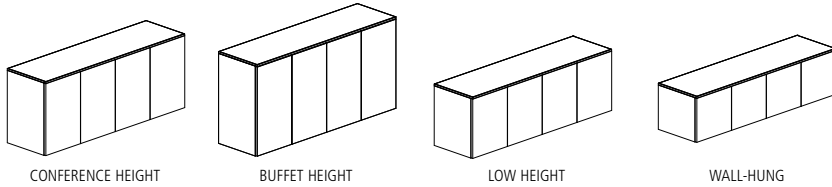

**CASE MATERIAL KEY**

PA Painted Case  
V Veneer Case

**CASE ONLY**

MODEL #	W x D x H	DESCRIPTION	-PA	-V
<b>CONFERENCE HEIGHT (29.5 INCH CASE)</b>				
FWCC-3629-W-P	36 x 20 x 29.5	Two Doors	5,367	5,469
FWCC-5429-W-P	54 x 20 x 29.5	Three Doors	6,982	7,116
FWCC-7229-W-P	72 x 20 x 29.5	Four Doors	8,602	8,769
FWCC-9029-W-P	90 x 20 x 29.5	Five Doors	10,222	10,421
FWCD-3629-W-P	36 x 24 x 29.5	Two Doors	5,900	6,013
FWCD-5429-W-P	54 x 24 x 29.5	Three Doors	7,679	7,828
FWCD-7229-W-P	72 x 24 x 29.5	Four Doors	9,460	9,646
FWCD-9029-W-P	90 x 24 x 29.5	Five Doors	11,243	11,461
<b>BUFFET HEIGHT (36.5 INCH CASE)</b>				
FWBC-3636-W-P	36 x 20 x 36.5	Two Doors	6,168	6,286
FWBC-5436-W-P	54 x 20 x 36.5	Three Doors	8,027	8,181
FWBC-7236-W-P	72 x 20 x 36.5	Four Doors	9,891	10,080
FWBC-9036-W-P	90 x 20 x 36.5	Five Doors	11,751	11,981
FWBD-3636-W-P	36 x 24 x 36.5	Two Doors	6,782	6,914
FWBD-5436-W-P	54 x 24 x 36.5	Three Doors	8,828	9,000
FWBD-7236-W-P	72 x 24 x 36.5	Four Doors	10,878	11,088
FWBD-9036-W-P	90 x 24 x 36.5	Five Doors	12,929	13,178
<b>LOW HEIGHT (24.5 INCH CASE)</b>				
FWLC-3624-W-P	36 x 20 x 24.5	Two Doors	4,968	5,065
FWLC-5424-W-P	54 x 20 x 24.5	Three Doors	6,466	6,591
FWLC-7224-W-P	72 x 20 x 24.5	Four Doors	7,964	8,122
FWLC-9024-W-P	90 x 20 x 24.5	Five Doors	9,464	9,650
FWLD-3624-W-P	36 x 24 x 24.5	Two Doors	5,464	5,570
FWLD-5424-W-P	54 x 24 x 24.5	Three Doors	7,113	7,249
FWLD-7224-W-P	72 x 24 x 24.5	Four Doors	8,760	8,931
FWLD-9024-W-P	90 x 24 x 24.5	Five Doors	10,413	10,613
<b>WALL-HUNG (18 INCH CASE)</b>				
FWWC-3618-W-P	36 x 20 x 18	Two Doors	4,560	4,647
FWWC-5418-W-P	54 x 20 x 18	Three Doors	5,937	6,051
FWWC-7218-W-P	72 x 20 x 18	Four Doors	7,311	7,454
FWWC-9018-W-P	90 x 20 x 18	Five Doors	8,689	8,857

**DOOR STYLE**

DESCRIPTION	CODE	NOTES	PRICE
Vertical Veneer	-VD		No Charge
Horizontal Veneer	-HD		No Charge
Veneer/Paint Combination	-VPD	Reference page 8 for predetermined accent door locations	No Charge
Painted	-PAD		No Charge





# LAMINATE TOP WITH HARDWOOD EDGE

OPTIONS	CODE	PRICE	NOTES
Locks	Add <b>-LK</b>	\$301	
Drawers Behind Doors (Buffet Height - 36" Case Only)	Add <b>-D</b>	\$587	
<b>Equipment Rack Options - Conference Height and Buffet Height Credenzas:</b>			
Fixed Equipment Rack	Add <b>-R2</b>	\$906	Available for 24" deep Credenzas, behind the left most pair of doors
Sliding Equipment Rack	Add <b>-R1</b>	\$3,317	Available for 24" deep Credenzas, behind the left most pair of doors
<b>Waste/Recycling Unit Options:</b>			
Single Pull-Out Waste/Recycling Unit	Add <b>-TF1</b>	\$295	Available for 20" deep Credenzas only (Wall-Hung excluded), behind right most doors
Double Pull-Out Waste/Recycling Unit	Add <b>-TF2</b>	\$456	Available for 24" depth credenzas only (Wall-Hung excluded), behind right most doors

**REQUIRED INFORMATION (ORDER CANNOT BE ENTERED WITHOUT THIS INFORMATION):**

See pages vi-vii for surface material options.

- Choose Door Style: Defaults to case finish, if none selected
- Choose Wood Species & Finish
- Choose Paint Finish, if specified
- Choose Laminate

**GENERAL INFORMATION**

- Tops are 3/4"-thick with 3/16"-deep hardwood edge band
- When veneer case is specified, the case exterior is standard slip-match layup regardless of veneer door style selection
- Pull-Out Waste/Recycling Bin size: 14" x 10-1/2" x 18"; (1) 36 Qt.; Double Pull-Out Waste/Recycling Units include two bins
- Locks
  - Veneer (Case Only) - When lock option is specified, color will default to Satin Nickel
  - Painted (Case Only) - When lock option is specified, color will default based on Paint finish:
    - Aged Bronze, Black, Galaxy, Shadow, and Storm: Black
    - Cloud: White
    - Burnish, Foil, Satin Bronze: Satin Nickel
    - Chrome: Polished Nickel
- Credenzas include one adjustable shelf behind each door unless other components are specified
- Equipment racks hold 12RU and include a thermostatically controlled fan and plug strip



# LAMINATE TOP WITH HARDWOOD EDGE

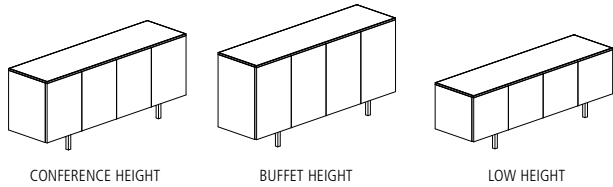

**CASE MATERIAL KEY**

PA-IB Painted Case with Inset Leg  
 V-IB Veneer Case with Inset Leg

**INSET LEG**

MODEL #	W x D x H	DESCRIPTION	-PA-IB	-V-IB
<b>CONFERENCE HEIGHT (24 IN. CASE WITH 6.5 IN. INSET LEG)</b>				
FWLC-3629-W-P	36 x 20 x 30.5	Two Doors	5,413	5,511
FWLC-5429-W-P	54 x 20 x 30.5	Three Doors	6,910	7,037
FWLC-7229-W-P	72 x 20 x 30.5	Four Doors	8,409	8,566
FWLC-9029-W-P	90 x 20 x 30.5	Five Doors	9,912	10,095
FWLD-3629-W-P	36 x 24 x 30.5	Two Doors	5,909	6,013
FWLD-5429-W-P	54 x 24 x 30.5	Three Doors	7,558	7,693
FWLD-7229-W-P	72 x 24 x 30.5	Four Doors	9,207	9,376
FWLD-9029-W-P	90 x 24 x 30.5	Five Doors	10,856	11,059
<b>BUFFET HEIGHT (29 IN. CASE WITH 6.5 IN. INSET LEG)</b>				
FWCC-3636-W-P	36 x 20 x 35.5	Two Doors	5,809	5,913
FWCC-5436-W-P	54 x 20 x 35.5	Three Doors	7,427	7,562
FWCC-7236-W-P	72 x 20 x 35.5	Four Doors	9,045	9,215
FWCC-9036-W-P	90 x 20 x 35.5	Five Doors	10,666	10,865
FWCD-3636-W-P	36 x 24 x 35.5	Two Doors	6,346	6,460
FWCD-5436-W-P	54 x 24 x 35.5	Three Doors	8,126	8,272
FWCD-7236-W-P	72 x 24 x 35.5	Four Doors	9,906	10,087
FWCD-9036-W-P	90 x 24 x 35.5	Five Doors	11,689	11,906
<b>LOW HEIGHT (18 IN. CASE WITH 6.5 IN. INSET LEG)</b>				
FWWC-3624-W-P	36 x 20 x 24.5	Two Doors	5,006	5,094
FWWC-5424-W-P	54 x 20 x 24.5	Three Doors	6,385	6,496
FWWC-7224-W-P	72 x 20 x 24.5	Four Doors	7,758	7,897
FWWC-9024-W-P	90 x 20 x 24.5	Five Doors	9,135	9,304

**DOOR STYLE**

DESCRIPTION	CODE	NOTES	PRICE
Vertical Veneer	-VD		No Charge
Horizontal Veneer	-HD		No Charge
Veneer/Paint Combination	-VPD	Reference page 8 for predetermined accent door locations	No Charge
Painted	-PAD		No Charge

OPTIONS	CODE	PRICE	NOTES
Locks	Add <b>-LK</b>	\$301	
Polished Chrome Base	Add <b>-PCIB</b>	\$479	
<b>Equipment Rack Options - Buffet Height Credenzas:</b>			
Fixed Equipment Rack	Add <b>-R2</b>	\$906	Available for 24" deep Credenzas, behind the left most pair of doors
Sliding Equipment Rack	Add <b>-R1</b>	\$3,317	Available for 24" deep Credenzas, behind the left most pair of doors
<b>Waste/Recycling Unit Options:</b>			
Single Pull-Out Waste/Recycling Unit	Add <b>-TF1</b>	\$295	Available for 20" deep Credenzas only (Wall-Hung excluded), behind right most doors
Double Pull-Out Waste/Recycling Unit	Add <b>-TF2</b>	\$456	Available for 24" depth credenzas only (Wall-Hung excluded), behind right most doors



# LAMINATE TOP WITH HARDWOOD EDGE

**REQUIRED INFORMATION (ORDER CANNOT BE ENTERED WITHOUT THIS INFORMATION):**

See pages vi-vii for surface material options.

- Choose Door Style: Defaults to case finish, if none selected
- Choose Metal Finish
- Choose Wood Species & Finish
- Choose Paint Finish, if specified
- Choose Laminate

**GENERAL INFORMATION**

---

- Tops are 3/4" -thick with 3/16" -deep hardwood edge band
- When veneer case is specified, the case exterior is standard slip-match layup regardless of veneer door style selection
- Pull-Out Waste/Recycling Bin size: 14" x 10-1/2" x 18"; (1) 36 Qt.; Double Pull-Out Waste/Recycling Units include two bins
- When lock option is specified, color will default based on leg finish:
  - Aged Bronze, Black, Galaxy, Shadow, and Storm: Black
  - Cloud: White
  - Burnish, Foil, and Satin Bronze: Satin Nickel
  - Chrome: Polished Nickel
- Credenzas include one adjustable shelf behind each door unless other components are specified
- Equipment racks hold 12RU and include a thermostatically controlled fan and plug strip



# LAMINATE TOP WITH HARDWOOD EDGE

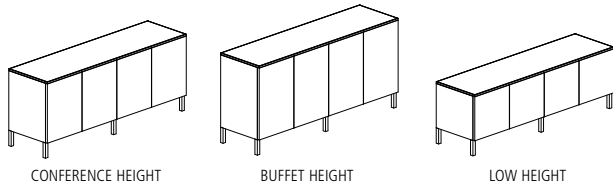

**CASE MATERIAL KEY**

PA-OB Painted Case with Edge-mount Post Leg  
 V-OB Veneer Case with Edge-mount Post Leg

**EDGE-MOUNT POST LEG**

MODEL #	W x D x H	DESCRIPTION	-PA-OB	-V-OB
<b>CONFERENCE HEIGHT (24 IN. CASE WITH 6.5 IN. EDGE-MOUNT POST LEG)</b>				
FWLC-3629-W-P	36 x 20 x 30.5	Two Door	5,413	5,511
FWLC-5429-W-P	54 x 20 x 30.5	Three Door	6,910	7,037
FWLC-7229-W-P	72 x 20 x 30.5	Four Door	8,409	8,566
FWLC-9029-W-P	90 x 20 x 30.5	Five Door	9,912	10,095
FWLD-3629-W-P	36 x 24 x 30.5	Two Door	5,909	6,013
FWLD-5429-W-P	54 x 24 x 30.5	Three Door	7,558	7,693
FWLD-7229-W-P	72 x 24 x 30.5	Four Door	9,207	9,376
FWLD-9029-W-P	90 x 24 x 30.5	Five Door	10,856	11,059
<b>BUFFET HEIGHT (29 IN. CASE WITH 6.5 IN. EDGE-MOUNT POST LEG)</b>				
FWCC-3636-W-P	36 x 20 x 35.5	Two Door	5,809	5,913
FWCC-5436-W-P	54 x 20 x 35.5	Three Door	7,427	7,562
FWCC-7236-W-P	72 x 20 x 35.5	Four Door	9,045	9,215
FWCC-9036-W-P	90 x 20 x 35.5	Five Door	10,666	10,865
FWCD-3636-W-P	36 x 24 x 35.5	Two Door	6,346	6,460
FWCD-5436-W-P	54 x 24 x 35.5	Three Door	8,126	8,272
FWCD-7236-W-P	72 x 24 x 35.5	Four Door	9,906	10,087
FWCD-9036-W-P	90 x 24 x 35.5	Five Door	11,689	11,906
<b>LOW HEIGHT (18 IN. CASE WITH 6.5 IN. EDGE-MOUNT POST LEG)</b>				
FWWC-3624-W-P	36 x 20 x 24.5	Two Door	5,006	5,094
FWWC-5424-W-P	54 x 20 x 24.5	Three Door	6,385	6,496
FWWC-7224-W-P	72 x 20 x 24.5	Four Door	7,758	7,897
FWWC-9024-W-P	90 x 20 x 24.5	Five Door	9,135	9,304

**DOOR STYLE**

DESCRIPTION	CODE	NOTES	PRICE
Vertical Veneer	-VD		No Charge
Horizontal Veneer	-HD		No Charge
Veneer/Paint Combination	-VPD	Reference page 8 for predetermined accent door locations	No Charge
Painted	-PAD		No Charge

OPTIONS	CODE	PRICE	NOTES
Locks	Add <b>-LK</b>	\$301	
Polished Chrome Base	Add <b>-PCOB</b>	\$517	
<b>Equipment Rack Options - Buffet Height Credenzas:</b>			
Fixed Equipment Rack	Add <b>-R2</b>	\$906	Available for 24" deep Credenzas, behind the left most pair of doors
Sliding Equipment Rack	Add <b>-R1</b>	\$3,317	Available for 24" deep Credenzas, behind the left most pair of doors
<b>Waste/Recycling Unit Options:</b>			
Single Pull-Out Waste/Recycling Unit	Add <b>-TF1</b>	\$295	Available for 20" deep Credenzas only (Wall-Hung excluded), behind right most doors
Double Pull-Out Waste/Recycling Unit	Add <b>-TF2</b>	\$456	Available for 24" depth credenzas only (Wall-Hung excluded), behind right most doors



# LAMINATE TOP WITH HARDWOOD EDGE

**REQUIRED INFORMATION (ORDER CANNOT BE ENTERED WITHOUT THIS INFORMATION):**

See pages vi-vii for surface material options.

- Choose Door Style: Defaults to case finish, if none selected
- Choose Metal Finish
- Choose Wood Species & Finish
- Choose Paint Finish, if specified
- Choose Laminate

**GENERAL INFORMATION**

---

- Tops are 3/4" -thick with 3/16" -deep hardwood edge band
- When veneer case is specified, the case exterior is standard slip-match layup regardless of veneer door style selection
- Pull-Out Waste/Recycling Bin size: 14" x 10-1/2" x 18"; (1) 36 Qt.; Double Pull-Out Waste/Recycling Units include two bins
- When lock option is specified, color will default based on leg finish:
  - Aged Bronze, Black, Galaxy, Shadow, and Storm: Black
  - Cloud: White
  - Burnish, Foil, and Satin Bronze: Satin Nickel
  - Chrome: Polished Nickel
- Credenzas include one adjustable shelf behind each door unless other components are specified
- Equipment racks hold 12RU and include a thermostatically controlled fan and plug strip



# LAMINATE TOP WITH HARDWOOD EDGE

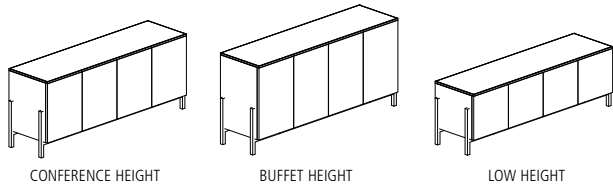

**CASE MATERIAL KEY**

PA-CB Painted Case with Cradle Base  
 V-CB Veneer Case with Cradle Base

**CRADLE BASE**

MODEL #	W x D x H	DESCRIPTION	-PA-CB	-V-CB
<b>CONFERENCE HEIGHT (24 IN. CASE WITH 6.5 IN. CRADLE BASE)</b>				
FWLC-3629-W-P	36 x 20 x 30.5	Two Doors	6,004	6,103
FWLC-5429-W-P	54 x 20 x 30.5	Three Doors	7,504	7,629
FWLC-7229-W-P	72 x 20 x 30.5	Four Doors	9,003	9,161
FWLC-9029-W-P	90 x 20 x 30.5	Five Doors	10,503	10,689
FWLD-3629-W-P	36 x 24 x 30.5	Two Doors	6,502	6,607
FWLD-5429-W-P	54 x 24 x 30.5	Three Doors	8,151	8,288
FWLD-7229-W-P	72 x 24 x 30.5	Four Doors	9,801	9,968
FWLD-9029-W-P	90 x 24 x 30.5	Five Doors	11,448	11,652
<b>BUFFET HEIGHT (29 IN. CASE WITH 6.5 IN. CRADLE BASE)</b>				
FWCC-3636-W-P	36 x 20 x 35.5	Two Doors	6,402	6,507
FWCC-5436-W-P	54 x 20 x 35.5	Three Doors	8,022	8,154
FWCC-7236-W-P	72 x 20 x 35.5	Four Doors	9,639	9,808
FWCC-9036-W-P	90 x 20 x 35.5	Five Doors	11,262	11,458
FWCD-3636-W-P	36 x 24 x 35.5	Two Doors	6,940	7,052
FWCD-5436-W-P	54 x 24 x 35.5	Three Doors	8,721	8,866
FWCD-7236-W-P	72 x 24 x 35.5	Four Doors	10,500	10,681
FWCD-9036-W-P	90 x 24 x 35.5	Five Doors	12,282	12,502
<b>LOW HEIGHT (18 IN. CASE WITH 6.5 IN. CRADLE BASE)</b>				
FWWC-3624-W-P	36 x 20 x 24.5	Two Doors	5,598	5,686
FWWC-5424-W-P	54 x 20 x 24.5	Three Doors	6,978	7,089
FWWC-7224-W-P	72 x 20 x 24.5	Four Doors	8,351	8,491
FWWC-9024-W-P	90 x 20 x 24.5	Five Doors	9,729	9,896

**DOOR STYLE**

DESCRIPTION	CODE	NOTES	PRICE
Vertical Veneer	-VD		No Charge
Horizontal Veneer	-HD		No Charge
Veneer/Paint Combination	-VPD	Reference page 8 for predetermined accent door locations	No Charge
Painted	-PAD		No Charge

OPTIONS	CODE	PRICE	NOTES
Locks	Add <b>-LK</b>	\$301	
Polished Chrome Base	Add <b>-PCCB</b>	\$1,698	
<b>Equipment Rack Options - Buffet Height Credenzas:</b>			
Fixed Equipment Rack	Add <b>-R2</b>	\$906	Available for 24" deep Credenzas, behind the left most pair of doors
Sliding Equipment Rack	Add <b>-R1</b>	\$3,317	Available for 24" deep Credenzas, behind the left most pair of doors
<b>Waste/Recycling Unit Options:</b>			
Single Pull-Out Waste/Recycling Unit	Add <b>-TF1</b>	\$295	Available for 20" deep Credenzas only (Wall-Hung excluded), behind right most doors
Double Pull-Out Waste/Recycling Unit	Add <b>-TF2</b>	\$456	Available for 24" depth credenzas only (Wall-Hung excluded), behind right most doors



# LAMINATE TOP WITH HARDWOOD EDGE

**REQUIRED INFORMATION (ORDER CANNOT BE ENTERED WITHOUT THIS INFORMATION):**

See pages vi-vii for surface material options.

- Choose Door Style: Defaults to case finish, if none selected
- Choose Metal Finish
- Choose Wood Species & Finish
- Choose Paint Finish, if specified
- Choose Laminate

**GENERAL INFORMATION**

---

- Tops are 3/4" -thick with 3/16" -deep hardwood edge band
- When veneer case is specified, the case exterior is standard slip-match layup regardless of veneer door style selection
- Pull-Out Waste/Recycling Bin size: 14" x 10-1/2" x 18"; (1) 36 Qt.; Double Pull-Out Waste/Recycling Units include two bins
- When lock option is specified, color will default based on leg finish:
  - Aged Bronze, Black, Galaxy, Shadow, and Storm: Black
  - Cloud: White
  - Burnish, Foil, and Satin Bronze: Satin Nickel
  - Chrome: Polished Nickel
- Credenzas include one adjustable shelf behind each door unless other components are specified
- Equipment racks hold 12RU and include a thermostatically controlled fan and plug strip



# LAMINATE TOP WITH HARDWOOD EDGE

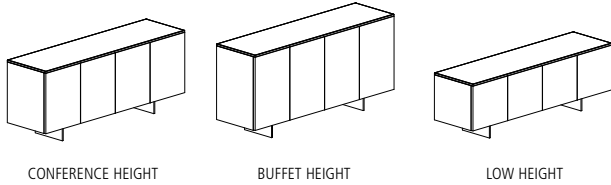

**CASE MATERIAL KEY**

PA-BB Painted Case with Blade Base  
 V-BB Veneer Case with Blade Base

**BLADE BASE**

MODEL #	W x D x H	DESCRIPTION	-PA-BB	-V-BB
<b>CONFERENCE HEIGHT (24 IN. CASE WITH 6.5 IN. BLADE LEG)</b>				
FWLC-3629-W-P	36 x 20 x 30.5	Two Doors	5,709	5,806
FWLC-5429-W-P	54 x 20 x 30.5	Three Doors	7,205	7,331
FWLC-7229-W-P	72 x 20 x 30.5	Four Doors	8,706	8,862
FWLC-9029-W-P	90 x 20 x 30.5	Five Doors	10,206	10,391
FWLD-3629-W-P	36 x 24 x 30.5	Two Doors	6,203	6,311
FWLD-5429-W-P	54 x 24 x 30.5	Three Doors	7,848	7,990
FWLD-7229-W-P	72 x 24 x 30.5	Four Doors	9,500	9,672
FWLD-9029-W-P	90 x 24 x 30.5	Five Doors	11,150	11,354
<b>BUFFET HEIGHT (29 IN. CASE WITH 6.5 IN. BLADE LEG)</b>				
FWCC-3636-W-P	36 x 20 x 35.5	Two Doors	6,104	6,211
FWCC-5436-W-P	54 x 20 x 35.5	Three Doors	7,721	7,858
FWCC-7236-W-P	72 x 20 x 35.5	Four Doors	9,341	9,513
FWCC-9036-W-P	90 x 20 x 35.5	Five Doors	10,960	11,162
FWCD-3636-W-P	36 x 24 x 35.5	Two Doors	6,640	6,757
FWCD-5436-W-P	54 x 24 x 35.5	Three Doors	8,418	8,568
FWCD-7236-W-P	72 x 24 x 35.5	Four Doors	10,202	10,387
FWCD-9036-W-P	90 x 24 x 35.5	Five Doors	11,983	12,205
<b>LOW HEIGHT (18 IN. CASE WITH 6.5 IN. BLADE LEG)</b>				
FWWC-3624-W-P	36 x 20 x 24.5	Two Doors	5,300	5,391
FWWC-5424-W-P	54 x 20 x 24.5	Three Doors	6,677	6,795
FWWC-7224-W-P	72 x 20 x 24.5	Four Doors	8,052	8,195
FWWC-9024-W-P	90 x 20 x 24.5	Five Doors	9,428	9,599

**DOOR STYLE**

DESCRIPTION	CODE	NOTES	PRICE
Vertical Veneer	-VD		No Charge
Horizontal Veneer	-HD		No Charge
Veneer/Paint Combination	-VPD	Reference page 8 for predetermined accent door locations	No Charge
Painted	-PAD		No Charge

OPTIONS	CODE	PRICE	NOTES
Locks	Add <b>-LK</b>	\$301	
Polished Chrome Base	Add <b>-PCBB</b>	\$479	
<b>Equipment Rack Options - Buffet Height Credenzas:</b>			
Fixed Equipment Rack	Add <b>-R2</b>	\$906	Available for 24" deep Credenzas, behind the left most pair of doors
Sliding Equipment Rack	Add <b>-R1</b>	\$3,317	Available for 24" deep Credenzas, behind the left most pair of doors
<b>Waste/Recycling Unit Options:</b>			
Single Pull-Out Waste/Recycling Unit	Add <b>-TF1</b>	\$295	Available for 20" deep Credenzas only (Wall-Hung excluded), behind right most doors
Double Pull-Out Waste/Recycling Unit	Add <b>-TF2</b>	\$456	Available for 24" depth credenzas only (Wall-Hung excluded), behind right most doors





# LAMINATE TOP WITH HARDWOOD EDGE

**REQUIRED INFORMATION (ORDER CANNOT BE ENTERED WITHOUT THIS INFORMATION):**

See pages vi-vii for surface material options.

- Choose Door Style: Defaults to case finish, if none selected
- Choose Metal Finish
- Choose Wood Species & Finish
- Choose Paint Finish, if specified
- Choose Laminate

**GENERAL INFORMATION**

---

- Tops are 3/4" -thick with 3/16" -deep hardwood edge band
- When veneer case is specified, the case exterior is standard slip-match layup regardless of veneer door style selection
- Pull-Out Waste/Recycling Bin size: 14" x 10-1/2" x 18"; (1) 36 Qt.; Double Pull-Out Waste/Recycling Units include two bins
- When lock option is specified, color will default based on leg finish:
  - Aged Bronze, Black, Galaxy, Shadow, and Storm: Black
  - Cloud: White
  - Burnish, Foil, and Satin Bronze: Satin Nickel
  - Chrome: Polished Nickel
- Credenzas include one adjustable shelf behind each door unless other components are specified
- Equipment racks hold 12RU and include a thermostatically controlled fan and plug strip



# LAMINATE TOP WITH ABS EDGE

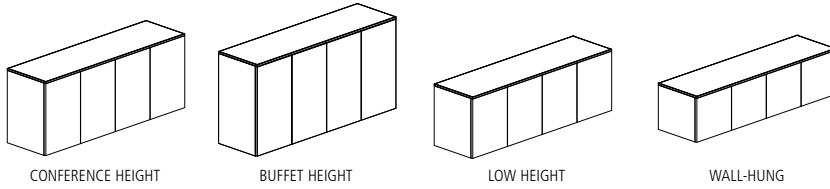

**CASE MATERIAL KEY**

PA Painted Case  
 PEC Laminate Case

**CASE ONLY**

MODEL #	W x D x H	DESCRIPTION	-PA	-PEC
<b>CONFERENCE HEIGHT (29.5 INCH CASE)</b>				
FWCC-3629-PE	36 x 20 x 29.5	Two Doors	5,206	4,700
FWCC-5429-PE	54 x 20 x 29.5	Three Doors	6,778	6,116
FWCC-7229-PE	72 x 20 x 29.5	Four Doors	8,351	7,537
FWCC-9029-PE	90 x 20 x 29.5	Five Doors	9,924	8,956
FWCD-3629-PE	36 x 24 x 29.5	Two Doors	5,728	5,168
FWCD-5429-PE	54 x 24 x 29.5	Three Doors	7,456	6,730
FWCD-7229-PE	72 x 24 x 29.5	Four Doors	9,186	8,290
FWCD-9029-PE	90 x 24 x 29.5	Five Doors	10,916	9,852
<b>BUFFET HEIGHT (36.5 INCH CASE)</b>				
FWBC-3636-PE	36 x 20 x 36.5	Two Doors	5,986	5,402
FWBC-5436-PE	54 x 20 x 36.5	Three Doors	7,793	7,033
FWBC-7236-PE	72 x 20 x 36.5	Four Doors	9,602	8,666
FWBC-9036-PE	90 x 20 x 36.5	Five Doors	11,410	10,298
FWBD-3636-PE	36 x 24 x 36.5	Two Doors	6,589	5,946
FWBD-5436-PE	54 x 24 x 36.5	Three Doors	8,573	7,738
FWBD-7236-PE	72 x 24 x 36.5	Four Doors	10,562	9,533
FWBD-9036-PE	90 x 24 x 36.5	Five Doors	12,549	11,327
<b>LOW HEIGHT (24.5 INCH CASE)</b>				
FWLC-3624-PE	36 x 20 x 24.5	Two Doors	4,821	4,352
FWLC-5424-PE	54 x 20 x 24.5	Three Doors	6,275	5,664
FWLC-7224-PE	72 x 20 x 24.5	Four Doors	7,731	6,978
FWLC-9024-PE	90 x 20 x 24.5	Five Doors	9,187	8,291
FWLD-3624-PE	36 x 24 x 24.5	Two Doors	5,304	4,788
FWLD-5424-PE	54 x 24 x 24.5	Three Doors	6,905	6,231
FWLD-7224-PE	72 x 24 x 24.5	Four Doors	8,507	7,677
FWLD-9024-PE	90 x 24 x 24.5	Five Doors	10,107	9,123
<b>WALL-HUNG (18 INCH CASE)</b>				
FWWC-3618-PE	36 x 20 x 18	Two Doors	4,430	3,995
FWWC-5418-PE	54 x 20 x 18	Three Doors	5,766	5,204
FWWC-7218-PE	72 x 20 x 18	Four Doors	7,098	6,407
FWWC-9018-PE	90 x 20 x 18	Five Doors	8,437	7,614

**DOOR STYLE**

DESCRIPTION	CODE	NOTES	PRICE
Laminate	-PED	Woodgrain laminate will be vertical on door	No Charge
Painted	-PAD		No Charge



# LAMINATE TOP WITH ABS EDGE

OPTIONS	CODE	PRICE	NOTES
Locks	Add <b>-LK</b>	\$301	
Drawers Behind Doors (Buffet Height - 36" Case Only)	Add <b>-D</b>	\$587	
<b>Equipment Rack Options - Conference Height and Buffet Height Credenzas:</b>			
Fixed Equipment Rack	Add <b>-R2</b>	\$906	Available for 24" deep Credenzas, behind the left most pair of doors
Sliding Equipment Rack	Add <b>-R1</b>	\$3,317	Available for 24" deep Credenzas, behind the left most pair of doors
<b>Waste/Recycling Unit Options:</b>			
Single Pull-Out Waste/Recycling Unit	Add <b>-TF1</b>	\$295	Available for 20" deep Credenzas only (Wall-Hung excluded), behind right most doors
Double Pull-Out Waste/Recycling Unit	Add <b>-TF2</b>	\$456	Available for 24" depth credenzas only (Wall-Hung excluded), behind right most doors

**REQUIRED INFORMATION (ORDER CANNOT BE ENTERED WITHOUT THIS INFORMATION):**

See pages vi-vii for surface material options.

- Choose Door Style: Defaults to case finish, if none selected
- Choose Paint Finish, if specified
- Choose Laminate
- Choose Edge Color: Defaults to matching edge band, if none selected

**GENERAL INFORMATION**

- Laminate Top with ABS Edge
  - Tops are 3/4" -thick with a 2 mm ABS edge
  - Solid and patterned laminates default to suggested solid color edge band
  - Wood grain laminates default to matching woodgrain edge band
- When veneer case is specified, the case exterior is standard slip-match layup regardless of veneer door style selection
- Pull-Out Waste/Recycling Bin Size: 14" x 10-1/2" x 18"; (1) 36 Qt.; Double Pull-Out Waste/Recycling Units include two bins
- Locks
  - Painted (Case Only) - When lock option is specified, color will default based on Paint finish:
    - Aged Bronze, Black, Galaxy, Shadow, and Storm: Black
    - Cloud: White
    - Burnish, Foil, Satin Bronze: Satin Nickel
    - Chrome: Polished Nickel
  - Woodgrain Laminate (Case Only) - When lock option is specified, color will default to Satin Nickel
  - Solid Laminate (Case Only) - When lock option is specified, color will default based on Laminate finish:
    - Brite White, Dover White, Pearl: White
    - Graystone, Folkstone: Satin Nickel
    - Graphite: Black
- Credenzas include one adjustable shelf behind each door unless other components are specified
- Equipment racks hold 12RU and include a thermostatically controlled fan and plug strip



# LAMINATE TOP WITH ABS EDGE

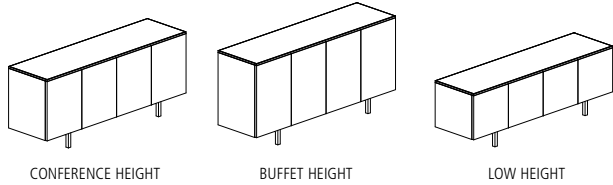

**CASE MATERIAL KEY**

PA-IB Painted Case with Inset Leg  
 PEC-IB Laminate Case with Inset Leg

**INSET LEG**

MODEL #	W x D x H	DESCRIPTION	-PA-IB	-PEC-IB
<b>CONFERENCE HEIGHT (24 IN. CASE WITH 6.5 IN. INSET LEG)</b>				
FWLC-3629-PE	36 x 20 x 30.5	Two Doors	5,270	4,755
FWLC-5429-PE	54 x 20 x 30.5	Three Doors	6,723	6,068
FWLC-7229-PE	72 x 20 x 30.5	Four Doors	8,179	7,380
FWLC-9029-PE	90 x 20 x 30.5	Five Doors	9,633	8,694
FWLD-3629-PE	36 x 24 x 30.5	Two Doors	5,750	5,188
FWLD-5429-PE	54 x 24 x 30.5	Three Doors	7,350	6,635
FWLD-7229-PE	72 x 24 x 30.5	Four Doors	8,953	8,080
FWLD-9029-PE	90 x 24 x 30.5	Five Doors	10,551	9,525
<b>BUFFET HEIGHT (29 IN. CASE WITH 6.5 IN. INSET LEG)</b>				
FWCC-3636-PE	36 x 20 x 35.5	Two Doors	5,655	5,103
FWCC-5436-PE	54 x 20 x 35.5	Three Doors	7,223	6,517
FWCC-7236-PE	72 x 20 x 35.5	Four Doors	8,795	7,939
FWCC-9036-PE	90 x 20 x 35.5	Five Doors	10,368	9,356
FWCD-3636-PE	36 x 24 x 35.5	Two Doors	6,175	5,572
FWCD-5436-PE	54 x 24 x 35.5	Three Doors	7,902	7,132
FWCD-7236-PE	72 x 24 x 35.5	Four Doors	9,631	8,692
FWCD-9036-PE	90 x 24 x 35.5	Five Doors	11,361	10,253
<b>LOW HEIGHT (18 IN. CASE WITH 6.5 IN. INSET LEG)</b>				
FWWC-3624-PE	36 x 20 x 24.5	Two Doors	4,871	4,398
FWWC-5424-PE	54 x 20 x 24.5	Three Doors	6,211	5,605
FWWC-7224-PE	72 x 20 x 24.5	Four Doors	7,544	6,807
FWWC-9024-PE	90 x 20 x 24.5	Five Doors	8,881	8,013

**DOOR STYLE**

DESCRIPTION	CODE	NOTES	PRICE
Laminate	-PED	Woodgrain laminate will be vertical on door	No Charge
Painted	-PAD		No Charge

OPTIONS	CODE	PRICE	NOTES
Locks	Add <b>-LK</b>	\$301	
Polished Chrome Base	Add <b>-PCIB</b>	\$479	
<b>Equipment Rack Options - Buffet Height Credenzas:</b>			
Fixed Equipment Rack	Add <b>-R2</b>	\$906	Available for 24" deep Credenzas, behind the left most pair of doors
Sliding Equipment Rack	Add <b>-R1</b>	\$3,317	Available for 24" deep Credenzas, behind the left most pair of doors
<b>Waste/Recycling Unit Options:</b>			
Single Pull-Out Waste/Recycling Unit	Add <b>-TF1</b>	\$295	Available for 20" deep Credenzas only (Wall-Hung excluded), behind right most doors
Double Pull-Out Waste/Recycling Unit	Add <b>-TF2</b>	\$456	Available for 24" depth credenzas only (Wall-Hung excluded), behind right most doors



# LAMINATE TOP WITH ABS EDGE

**REQUIRED INFORMATION (ORDER CANNOT BE ENTERED WITHOUT THIS INFORMATION):**

See pages vi-vii for surface material options.

- Choose Door Style: Defaults to case finish, if none selected
- Choose Metal Finish
- Choose Paint Finish, if specified
- Choose Laminate
- Choose Edge Color: Defaults to matching edge band, if none selected

**GENERAL INFORMATION**

- Laminate Top with ABS Edge
  - Tops are 3/4"-thick with a 2 mm ABS edge
  - Solid and patterned laminates default to suggested solid color edge band
  - Wood grain laminates default to matching woodgrain edge band
- When veneer case is specified, the case exterior is standard slip-match layup regardless of veneer door style selection
- Pull-Out Waste/Recycling Bin size: 14" x 10-1/2" x 18"; (1) 36 Qt.; Double Pull-Out Waste/Recycling Units include two bins
- When lock option is specified, color will default based on leg finish:
  - Aged Bronze, Black, Galaxy, Shadow, and Storm: Black
  - Cloud: White
  - Burnish, Foil, and Satin Bronze: Satin Nickel
  - Chrome: Polished Nickel
- Credenzas include one adjustable shelf behind each door unless other components are specified
- Equipment racks hold 12RU and include a thermostatically controlled fan and plug strip



# LAMINATE TOP WITH ABS EDGE

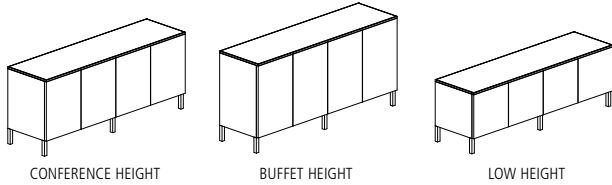

**CASE MATERIAL KEY**

PA-OB Painted Case with Edge-mount Post Leg  
 PEC-OB Laminate Case with Edge-mount Post Leg

**EDGE-MOUNT POST LEG**

MODEL #	W x D x H	DESCRIPTION	-PA-OB	-PEC-OB
<b>CONFERENCE HEIGHT (24 IN. CASE WITH 6.5 IN. EDGE-MOUNT POST LEG)</b>				
FWLC-3629-PE	36 x 20 x 30.5	Two Door	5,270	4,755
FWLC-5429-PE	54 x 20 x 30.5	Three Door	6,723	6,068
FWLC-7229-PE	72 x 20 x 30.5	Four Door	8,179	7,380
FWLC-9029-PE	90 x 20 x 30.5	Five Door	9,633	8,694
FWLD-3629-PE	36 x 24 x 30.5	Two Door	5,750	5,188
FWLD-5429-PE	54 x 24 x 30.5	Three Door	7,350	6,635
FWLD-7229-PE	72 x 24 x 30.5	Four Door	8,953	8,080
FWLD-9029-PE	90 x 24 x 30.5	Five Door	10,551	9,525
<b>BUFFET HEIGHT (29 IN. CASE WITH 6.5 IN. EDGE-MOUNT POST LEG)</b>				
FWCC-3636-PE	36 x 20 x 35.5	Two Door	5,655	5,103
FWCC-5436-PE	54 x 20 x 35.5	Three Door	7,223	6,517
FWCC-7236-PE	72 x 20 x 35.5	Four Door	8,795	7,939
FWCC-9036-PE	90 x 20 x 35.5	Five Door	10,368	9,356
FWCD-3636-PE	36 x 24 x 35.5	Two Door	6,175	5,572
FWCD-5436-PE	54 x 24 x 35.5	Three Door	7,902	7,132
FWCD-7236-PE	72 x 24 x 35.5	Four Door	9,631	8,692
FWCD-9036-PE	90 x 24 x 35.5	Five Door	11,361	10,253
<b>LOW HEIGHT (18 IN. CASE WITH 6.5 IN. EDGE-MOUNT POST LEG)</b>				
FWWC-3624-PE	36 x 20 x 24.5	Two Door	4,871	4,398
FWWC-5424-PE	54 x 20 x 24.5	Three Door	6,211	5,605
FWWC-7224-PE	72 x 20 x 24.5	Four Door	7,544	6,807
FWWC-9024-PE	90 x 20 x 24.5	Five Door	8,881	8,013

**DOOR STYLE**

DESCRIPTION	CODE	NOTES	PRICE
Laminate	-PED	Woodgrain laminate will be vertical on door	No Charge
Painted	-PAD		No Charge

OPTIONS	CODE	PRICE	NOTES
Locks	Add <b>-LK</b>	\$301	
Polished Chrome Base	Add <b>-PCOB</b>	\$517	
<b>Equipment Rack Options - Buffet Height Credenzas:</b>			
Fixed Equipment Rack	Add <b>-R2</b>	\$906	Available for 24" deep Credenzas, behind the left most pair of doors
Sliding Equipment Rack	Add <b>-R1</b>	\$3,317	Available for 24" deep Credenzas, behind the left most pair of doors
<b>Waste/Recycling Unit Options:</b>			
Single Pull-Out Waste/Recycling Unit	Add <b>-TF1</b>	\$295	Available for 20" deep Credenzas only (Wall-Hung excluded), behind right most doors
Double Pull-Out Waste/Recycling Unit	Add <b>-TF2</b>	\$456	Available for 24" depth Credenzas only (Wall-Hung excluded), behind right most doors



# LAMINATE TOP WITH ABS EDGE

**REQUIRED INFORMATION (ORDER CANNOT BE ENTERED WITHOUT THIS INFORMATION):**

See pages vi-vii for surface material options.

- Choose Door Style: Defaults to case finish, if none selected
- Choose Metal Finish
- Choose Paint Finish, if specified
- Choose Laminate
- Choose Edge Color: Defaults to matching edge band, if none selected

**GENERAL INFORMATION**

- Laminate Top with ABS Edge
  - Tops are 3/4"-thick with a 2 mm ABS edge
  - Solid and patterned laminates default to suggested solid color edge band
  - Wood grain laminates default to matching woodgrain edge band
- When veneer case is specified, the case exterior is standard slip-match layup regardless of veneer door style selection
- Pull-Out Waste/Recycling Bin size: 14" x 10-1/2" x 18"; (1) 36 Qt.; Double Pull-Out Waste/Recycling Units include two bins
- When lock option is specified, color will default based on leg finish:
  - Aged Bronze, Black, Galaxy, Shadow, and Storm: Black
  - Cloud: White
  - Burnish, Foil, and Satin Bronze: Satin Nickel
  - Chrome: Polished Nickel
- Credenzas include one adjustable shelf behind each door unless other components are specified
- Equipment racks hold 12RU and include a thermostatically controlled fan and plug strip



# LAMINATE TOP WITH ABS EDGE

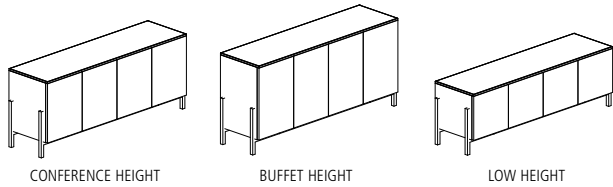

**CASE MATERIAL KEY**

PA-CB Painted Case with Cradle Base  
 PEC-CB Laminate Case with Cradle Base

**CRADLE BASE**

MODEL #	W x D x H	DESCRIPTION	-PA-CB	-PEC-CB
<b>CONFERENCE HEIGHT (24 IN. CASE WITH 6.5 IN. CRADLE BASE)</b>				
FWLC-3629-PE	36 x 20 x 30.5	Two Doors	5,862	5,291
FWLC-5429-PE	54 x 20 x 30.5	Three Doors	7,315	6,602
FWLC-7229-PE	72 x 20 x 30.5	Four Doors	8,772	7,916
FWLC-9029-PE	90 x 20 x 30.5	Five Doors	10,228	9,230
FWLD-3629-PE	36 x 24 x 30.5	Two Doors	6,343	5,723
FWLD-5429-PE	54 x 24 x 30.5	Three Doors	7,943	7,170
FWLD-7229-PE	72 x 24 x 30.5	Four Doors	9,547	8,616
FWLD-9029-PE	90 x 24 x 30.5	Five Doors	11,146	10,060
<b>BUFFET HEIGHT (29 IN. CASE WITH 6.5 IN. CRADLE BASE)</b>				
FWCC-3636-PE	36 x 20 x 35.5	Two Doors	6,247	5,638
FWCC-5436-PE	54 x 20 x 35.5	Three Doors	7,816	7,055
FWCC-7236-PE	72 x 20 x 35.5	Four Doors	9,390	8,473
FWCC-9036-PE	90 x 20 x 35.5	Five Doors	10,960	9,892
FWCD-3636-PE	36 x 24 x 35.5	Two Doors	6,767	6,107
FWCD-5436-PE	54 x 24 x 35.5	Three Doors	8,493	7,665
FWCD-7236-PE	72 x 24 x 35.5	Four Doors	10,225	9,225
FWCD-9036-PE	90 x 24 x 35.5	Five Doors	11,954	10,787
<b>LOW HEIGHT (18 IN. CASE WITH 6.5 IN. CRADLE BASE)</b>				
FWWC-3624-PE	36 x 20 x 24.5	Two Doors	5,465	4,932
FWWC-5424-PE	54 x 20 x 24.5	Three Doors	6,802	6,142
FWWC-7224-PE	72 x 20 x 24.5	Four Doors	8,137	7,345
FWWC-9024-PE	90 x 20 x 24.5	Five Doors	9,473	8,549

**DOOR STYLE**

DESCRIPTION	CODE	NOTES	PRICE
Laminate	-PED	Woodgrain laminate will be vertical on door	No Charge
Painted	-PAD		No Charge

OPTIONS	CODE	PRICE	NOTES
Locks	Add <b>-LK</b>	\$301	
Polished Chrome Base	Add <b>-PCCB</b>	\$1,698	
<b>Equipment Rack Options - Buffet Height Credenzas:</b>			
Fixed Equipment Rack	Add <b>-R2</b>	\$906	Available for 24" deep Credenzas, behind the left most pair of doors
Sliding Equipment Rack	Add <b>-R1</b>	\$3,317	Available for 24" deep Credenzas, behind the left most pair of doors
<b>Waste/Recycling Unit Options:</b>			
Single Pull-Out Waste/Recycling Unit	Add <b>-TF1</b>	\$295	Available for 20" deep Credenzas only (Wall-Hung excluded), behind right most doors
Double Pull-Out Waste/Recycling Unit	Add <b>-TF2</b>	\$456	Available for 24" depth Credenzas only (Wall-Hung excluded), behind right most doors





# LAMINATE TOP WITH ABS EDGE

**REQUIRED INFORMATION (ORDER CANNOT BE ENTERED WITHOUT THIS INFORMATION):**

See pages vi-vii for surface material options.

- Choose Door Style: Defaults to case finish, if none selected
- Choose Metal Finish
- Choose Paint Finish, if specified
- Choose Laminate
- Choose Edge Color: Defaults to matching edge band, if none selected

**GENERAL INFORMATION**

---

- Laminate Top with ABS Edge
  - Tops are 3/4"-thick with a 2 mm ABS edge
  - Solid and patterned laminates default to suggested solid color edge band
  - Wood grain laminates default to matching woodgrain edge band
- When veneer case is specified, the case exterior is standard slip-match layup regardless of veneer door style selection
- Pull-Out Waste/Recycling Bin size: 14" x 10-1/2" x 18"; (1) 36 Qt.; Double Pull-Out Waste/Recycling Units include two bins
- When lock option is specified, color will default based on leg finish:
  - Aged Bronze, Black, Galaxy, Shadow, and Storm: Black
  - Cloud: White
  - Burnish, Foil, and Satin Bronze: Satin Nickel
  - Chrome: Polished Nickel
- Credenzas include one adjustable shelf behind each door unless other components are specified
- Equipment racks hold 12RU and include a thermostatically controlled fan and plug strip



# LAMINATE TOP WITH ABS EDGE

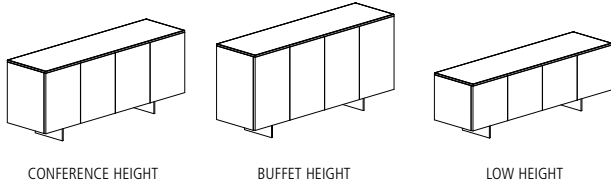

**CASE MATERIAL KEY**

PA-BB Painted Case with Blade Base  
 PEC-BB Laminate Case with Blade Base

**BLADE BASE**

MODEL #	W x D x H	DESCRIPTION	-PA-BB	-PEC-BB
<b>CONFERENCE HEIGHT (24 IN. CASE WITH 6.5 IN. BLADE LEG)</b>				
FWLC-3629-PE	36 x 20 x 30.5	Two Doors	5,564	5,023
FWLC-5429-PE	54 x 20 x 30.5	Three Doors	7,017	6,334
FWLC-7229-PE	72 x 20 x 30.5	Four Doors	8,474	7,650
FWLC-9029-PE	90 x 20 x 30.5	Five Doors	9,932	8,963
FWLD-3629-PE	36 x 24 x 30.5	Two Doors	6,047	5,455
FWLD-5429-PE	54 x 24 x 30.5	Three Doors	7,647	6,901
FWLD-7229-PE	72 x 24 x 30.5	Four Doors	9,249	8,346
FWLD-9029-PE	90 x 24 x 30.5	Five Doors	10,850	9,791
<b>BUFFET HEIGHT (29 IN. CASE WITH 6.5 IN. BLADE LEG)</b>				
FWCC-3636-PE	36 x 20 x 35.5	Two Doors	5,949	5,371
FWCC-5436-PE	54 x 20 x 35.5	Three Doors	7,520	6,784
FWCC-7236-PE	72 x 20 x 35.5	Four Doors	9,091	8,206
FWCC-9036-PE	90 x 20 x 35.5	Five Doors	10,664	9,624
FWCD-3636-PE	36 x 24 x 35.5	Two Doors	6,469	5,839
FWCD-5436-PE	54 x 24 x 35.5	Three Doors	8,200	7,399
FWCD-7236-PE	72 x 24 x 35.5	Four Doors	9,929	8,959
FWCD-9036-PE	90 x 24 x 35.5	Five Doors	11,657	10,519
<b>LOW HEIGHT (18 IN. CASE WITH 6.5 IN. BLADE LEG)</b>				
FWWC-3624-PE	36 x 20 x 24.5	Two Doors	5,168	4,666
FWWC-5424-PE	54 x 20 x 24.5	Three Doors	6,507	5,871
FWWC-7224-PE	72 x 20 x 24.5	Four Doors	7,842	7,079
FWWC-9024-PE	90 x 20 x 24.5	Five Doors	9,175	8,281

**DOOR STYLE**

DESCRIPTION	CODE	NOTES	PRICE
Laminate	-PED	Woodgrain laminate will be vertical on door	No Charge
Painted	-PAD		No Charge

OPTIONS	CODE	PRICE	NOTES
Locks	Add <b>-LK</b>	\$301	
Polished Chrome Base	Add <b>-PCBB</b>	\$479	
<b>Equipment Rack Options - Buffet Height Credenzas:</b>			
Fixed Equipment Rack	Add <b>-R2</b>	\$906	Available for 24" deep Credenzas, behind the left most pair of doors
Sliding Equipment Rack	Add <b>-R1</b>	\$3,317	Available for 24" deep Credenzas, behind the left most pair of doors
<b>Waste/Recycling Unit Options:</b>			
Single Pull-Out Waste/Recycling Unit	Add <b>-TF1</b>	\$295	Available for 20" deep Credenzas only (Wall-Hung excluded), behind right most doors
Double Pull-Out Waste/Recycling Unit	Add <b>-TF2</b>	\$456	Available for 24" depth Credenzas only (Wall-Hung excluded), behind right most doors



# LAMINATE TOP WITH ABS EDGE

**REQUIRED INFORMATION (ORDER CANNOT BE ENTERED WITHOUT THIS INFORMATION):**

See pages vi-vii for surface material options.

- Choose Door Style: Defaults to case finish, if none selected
- Choose Metal Finish
- Choose Paint Finish, if specified
- Choose Laminate
- Choose Edge Color: Defaults to matching edge band, if none selected

**GENERAL INFORMATION**

---

- Laminate Top with ABS Edge
  - Tops are 3/4"-thick with a 2 mm ABS edge
  - Solid and patterned laminates default to suggested solid color edge band
  - Wood grain laminates default to matching woodgrain edge band
- When veneer case is specified, the case exterior is standard slip-match layup regardless of veneer door style selection
- Pull-Out Waste/Recycling Bin size: 14" x 10-1/2" x 18"; (1) 36 Qt.; Double Pull-Out Waste/Recycling Units include two bins
- When lock option is specified, color will default based on leg finish:
  - Aged Bronze, Black, Galaxy, Shadow, and Storm: Black
  - Cloud: White
  - Burnish, Foil, and Satin Bronze: Satin Nickel
  - Chrome: Polished Nickel
- Credenzas include one adjustable shelf behind each door unless other components are specified
- Equipment racks hold 12RU and include a thermostatically controlled fan and plug strip



# GLOSS GLASS TOP

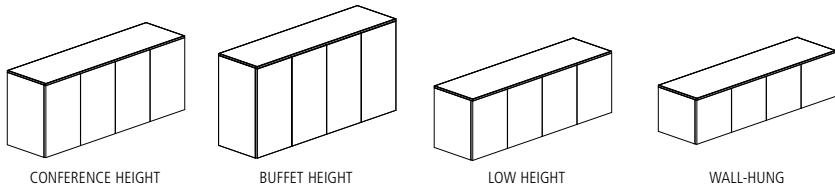

**CASE MATERIAL KEY**

PA Painted Case  
V Veneer Case

**CASE ONLY**

MODEL #	W x D x H	DESCRIPTION	-PA	-V
<b>CONFERENCE HEIGHT (29 INCH CASE)</b>				
FWCC-3629-GG	36 x 20 x 29	Two Doors	5,987	6,653
FWCC-5429-GG	54 x 20 x 29	Three Doors	7,794	8,660
FWCC-7229-GG	72 x 20 x 29	Four Doors	9,603	10,668
FWCC-9029-GG	90 x 20 x 29	Five Doors	11,411	12,677
FWCD-3629-GG	36 x 24 x 29	Two Doors	6,589	7,316
FWCD-5429-GG	54 x 24 x 29	Three Doors	8,575	9,525
FWCD-7229-GG	72 x 24 x 29	Four Doors	10,563	11,735
FWCD-9029-GG	90 x 24 x 29	Five Doors	12,552	13,943
<b>BUFFET HEIGHT (36 INCH CASE)</b>				
FWBC-3636-GG	36 x 20 x 36	Two Doors	6,885	7,647
FWBC-5436-GG	54 x 20 x 36	Three Doors	8,962	9,954
FWBC-7236-GG	72 x 20 x 36	Four Doors	11,043	12,264
FWBC-9036-GG	90 x 20 x 36	Five Doors	13,122	14,576
FWBD-3636-GG	36 x 24 x 36	Two Doors	7,573	8,412
FWBD-5436-GG	54 x 24 x 36	Three Doors	9,859	10,949
FWBD-7236-GG	72 x 24 x 36	Four Doors	12,145	13,490
FWBD-9036-GG	90 x 24 x 36	Five Doors	14,432	16,036
<b>LOW HEIGHT (24 INCH CASE)</b>				
FWLC-3624-GG	36 x 20 x 24	Two Doors	5,546	6,162
FWLC-5424-GG	54 x 20 x 24	Three Doors	7,215	8,021
FWLC-7224-GG	72 x 20 x 24	Four Doors	8,894	9,877
FWLC-9024-GG	90 x 20 x 24	Five Doors	10,567	11,740
FWLD-3624-GG	36 x 24 x 24	Two Doors	6,100	6,776
FWLD-5424-GG	54 x 24 x 24	Three Doors	7,941	8,821
FWLD-7224-GG	72 x 24 x 24	Four Doors	9,781	10,866
FWLD-9024-GG	90 x 24 x 24	Five Doors	11,622	12,911
<b>WALL-HUNG (17.5 INCH CASE)</b>				
FWWC-3618-GG	36 x 20 x 17.5	Two Doors	5,093	5,657
FWWC-5418-GG	54 x 20 x 17.5	Three Doors	6,629	7,360
FWWC-7218-GG	72 x 20 x 17.5	Four Doors	8,163	9,069
FWWC-9018-GG	90 x 20 x 17.5	Five Doors	9,701	10,778

**DOOR STYLE**

DESCRIPTION	CODE	NOTES	PRICE
Plank Veneer	-PWD	Available in Clear Coat Walnut	\$301
Vertical Veneer	-VD		No Charge
Horizontal Veneer	-HD		No Charge
Veneer/Paint Combination	-VPD	Reference page 8 for predetermined accent door locations	No Charge
Painted	-PAD		No Charge



# GLOSS GLASS TOP

OPTIONS	CODE	PRICE	NOTES
Locks	Add <b>-LK</b>	\$301	
Drawers Behind Doors (Buffet Height - 36" Case Only)	Add <b>-D</b>	\$587	
<b>Equipment Rack Options - Conference Height and Buffet Height Credenzas:</b>			
Fixed Equipment Rack	Add <b>-R2</b>	\$906	Available for 24" deep Credenzas, behind the left most pair of doors
Sliding Equipment Rack	Add <b>-R1</b>	\$3,317	Available for 24" deep Credenzas, behind the left most pair of doors
<b>Waste/Recycling Unit Options:</b>			
Single Pull-Out Waste/Recycling Unit	Add <b>-TF1</b>	\$295	Available for 20" deep Credenzas only (Wall-Hung excluded), behind right most doors
Double Pull-Out Waste/Recycling Unit	Add <b>-TF2</b>	\$456	Available for 24" depth credenzas only (Wall-Hung excluded), behind right most doors

**REQUIRED INFORMATION (ORDER CANNOT BE ENTERED WITHOUT THIS INFORMATION):**

See pages vi-vii for surface material options.

- Choose Door Style: Defaults to case finish, if none selected
- Choose Glass Finish
- Choose Paint Finish, if specified
- Choose Wood Species & Finish, if specified

**GENERAL INFORMATION**

- Glass is 1/4" -thick back-painted, low-iron glass
- Plank veneer is hand selected walnut veneers of varying character and color, with a clear coat finish, to accentuate the plank appearance
- When Plank veneer door style is specified with a veneer case, case and top will default to clear coat walnut in standard slip-match layup
- When veneer case is specified, the case exterior is standard slip-match layup regardless of veneer door style selection
- Pull-Out Waste/Recycling Bin size: 14" x 10-1/2" x 18"; (1) 36 Qt.; Double Pull-Out Waste/Recycling Units include two bins
- Locks
  - Veneer (Case Only) - When lock option is specified, color will default to Satin Nickel
  - Painted (Case Only) - When lock option is specified, color will default based on Paint finish:
    - Aged Bronze, Black, Galaxy, Shadow, and Storm: Black
    - Cloud: White
    - Burnish, Foil, Satin Bronze: Satin Nickel
    - Chrome: Polished Nickel
- Credenzas include one adjustable shelf behind each door unless other components are specified
- Equipment racks hold 12RU and include a thermostatically controlled fan and plug strip



# GLOSS GLASS TOP

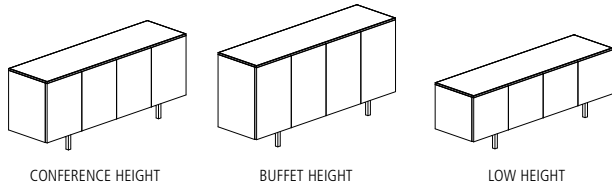

**CASE MATERIAL KEY**

PA-IB Painted Case with Inset Leg  
 V-IB Veneer Case with Inset Leg

**INSET LEG**

MODEL #	W x D x H	DESCRIPTION	-PA-IB	-V-IB
<b>CONFERENCE HEIGHT (23.5 IN. CASE WITH 6.5 IN. INSET LEG)</b>				
FWLC-3629-GG	36 x 20 x 30	Two Doors	5,990	6,606
FWLC-5429-GG	54 x 20 x 30	Three Doors	7,662	8,466
FWLC-7229-GG	72 x 20 x 30	Four Doors	9,338	10,325
FWLC-9029-GG	90 x 20 x 30	Five Doors	11,013	12,185
FWLD-3629-GG	36 x 24 x 30	Two Doors	6,542	7,217
FWLD-5429-GG	54 x 24 x 30	Three Doors	8,385	9,266
FWLD-7229-GG	72 x 24 x 30	Four Doors	10,227	11,312
FWLD-9029-GG	90 x 24 x 30	Five Doors	12,067	13,354
<b>BUFFET HEIGHT (28.5 IN. CASE WITH 6.5 IN. INSET LEG)</b>				
FWCC-3636-GG	36 x 20 x 35	Two Doors	6,434	7,095
FWCC-5436-GG	54 x 20 x 35	Three Doors	8,240	9,107
FWCC-7236-GG	72 x 20 x 35	Four Doors	10,049	11,116
FWCC-9036-GG	90 x 20 x 35	Five Doors	11,855	13,122
FWCD-3636-GG	36 x 24 x 35	Two Doors	7,032	7,761
FWCD-5436-GG	54 x 24 x 35	Three Doors	9,020	9,968
FWCD-7236-GG	72 x 24 x 35	Four Doors	11,009	12,180
FWCD-9036-GG	90 x 24 x 35	Five Doors	12,998	14,389
<b>LOW HEIGHT (17.5 IN. CASE WITH 6.5 IN. INSET LEG)</b>				
FWWC-3624-GG	36 x 20 x 24	Two Doors	5,536	6,101
FWWC-5424-GG	54 x 20 x 24	Three Doors	7,074	7,807
FWWC-7224-GG	72 x 20 x 24	Four Doors	8,610	9,515
FWWC-9024-GG	90 x 20 x 24	Five Doors	10,146	11,223

**DOOR STYLE**

DESCRIPTION	CODE	NOTES	PRICE
Plank Veneer	-PWD	Available in Clear Coat Walnut	\$301
Vertical Veneer	-VD		No Charge
Horizontal Veneer	-HD		No Charge
Veneer/Paint Combination	-VPD	Reference page 8 for predetermined accent door locations	No Charge
Painted	-PAD		No Charge

**OPTIONS**

	CODE	PRICE	NOTES
Locks	Add <b>-LK</b>	\$301	
Polished Chrome Base	Add <b>-PCIB</b>	\$479	
<b>Equipment Rack Options - Buffet Height Credenzas:</b>			
Fixed Equipment Rack	Add <b>-R2</b>	\$906	Available for 24" deep Credenzas, behind the left most pair of doors
Sliding Equipment Rack	Add <b>-R1</b>	\$3,317	Available for 24" deep Credenzas, behind the left most pair of doors
<b>Waste/Recycling Unit Options:</b>			
Single Pull-Out Waste/Recycling Unit	Add <b>-TF1</b>	\$295	Available for 20" deep Credenzas only (Wall-Hung excluded), behind right most doors
Double Pull-Out Waste/Recycling Unit	Add <b>-TF2</b>	\$456	Available for 24" depth credenzas only (Wall-Hung excluded), behind right most doors



# GLOSS GLASS TOP

**REQUIRED INFORMATION (ORDER CANNOT BE ENTERED WITHOUT THIS INFORMATION):**

See pages vi-vii for surface material options.

- Choose Door Style: Defaults to case finish, if none selected
- Choose Metal Finish
- Choose Glass Finish
- Choose Paint Finish, if specified
- Choose Wood Species & Finish, if specified

**GENERAL INFORMATION**

- Glass is 1/4" -thick back-painted, low-iron glass
- Plank veneer is hand selected walnut veneers of varying character and color, with a clear coat finish, to accentuate the plank appearance
- When Plank veneer door style is specified with a veneer case, case and top will default to clear coat walnut in standard slip-match layup
- When veneer case is specified, the case exterior is standard slip-match layup regardless of veneer door style selection
- Pull-Out Waste/Recycling Bin size: 14" x 10-1/2" x 18"; (1) 36 Qt.; Double Pull-Out Waste/Recycling Units include two bins
- When lock option is specified, color will default based on leg finish:
  - Aged Bronze, Black, Galaxy, Shadow, and Storm: Black
  - Cloud: White
  - Burnish, Foil, and Satin Bronze: Satin Nickel
  - Chrome: Polished Nickel
- Credenzas include one adjustable shelf behind each door unless other components are specified
- Equipment racks hold 12RU and include a thermostatically controlled fan and plug strip



# GLOSS GLASS TOP

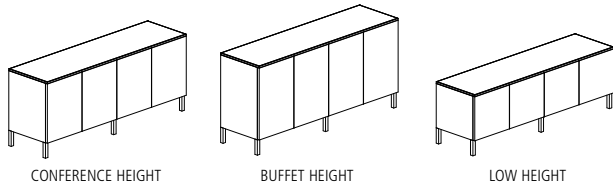

**CASE MATERIAL KEY**

PA-OB Painted Case with Edge-mount Post Leg  
 V-OB Veneer Case with Edge-mount Post Leg

**EDGE-MOUNT POST LEG**

MODEL #	W x D x H	DESCRIPTION	-PA-OB	-V-OB
<b>CONFERENCE HEIGHT (23.5 IN. CASE WITH 6.5 IN. EDGE-MOUNT POST LEG)</b>				
FWLC-3629-GG	36 x 20 x 30	Two Door	5,990	6,606
FWLC-5429-GG	54 x 20 x 30	Three Door	7,662	8,466
FWLC-7229-GG	72 x 20 x 30	Four Door	9,338	10,325
FWLC-9029-GG	90 x 20 x 30	Five Door	11,013	12,185
FWLD-3629-GG	36 x 24 x 30	Two Door	6,542	7,217
FWLD-5429-GG	54 x 24 x 30	Three Door	8,385	9,266
FWLD-7229-GG	72 x 24 x 30	Four Door	10,227	11,312
FWLD-9029-GG	90 x 24 x 30	Five Door	12,067	13,354
<b>BUFFET HEIGHT (28.5 IN. CASE WITH 6.5 IN. EDGE-MOUNT POST LEG)</b>				
FWCC-3636-GG	36 x 20 x 35	Two Door	6,434	7,095
FWCC-5436-GG	54 x 20 x 35	Three Door	8,240	9,107
FWCC-7236-GG	72 x 20 x 35	Four Door	10,049	11,116
FWCC-9036-GG	90 x 20 x 35	Five Door	11,855	13,122
FWCD-3636-GG	36 x 24 x 35	Two Door	7,032	7,761
FWCD-5436-GG	54 x 24 x 35	Three Door	9,020	9,968
FWCD-7236-GG	72 x 24 x 35	Four Door	11,009	12,180
FWCD-9036-GG	90 x 24 x 35	Five Door	12,998	14,389
<b>LOW HEIGHT (17.5 IN. CASE WITH 6.5 IN. EDGE-MOUNT POST LEG)</b>				
FWWC-3624-GG	36 x 20 x 24	Two Door	5,536	6,101
FWWC-5424-GG	54 x 20 x 24	Three Door	7,074	7,807
FWWC-7224-GG	72 x 20 x 24	Four Door	8,610	9,515
FWWC-9024-GG	90 x 20 x 24	Five Door	10,146	11,223

**DOOR STYLE**

DESCRIPTION	CODE	NOTES	PRICE
Plank Veneer	-PWD	Available in Clear Coat Walnut	\$301
Vertical Veneer	-VD		No Charge
Horizontal Veneer	-HD		No Charge
Veneer/Paint Combination	-VPD	Reference page 8 for predetermined accent door locations	No Charge
Painted	-PAD		No Charge

**OPTIONS**

	CODE	PRICE	NOTES
Locks	Add <b>-LK</b>	\$301	
Polished Chrome Base	Add <b>-PCOB</b>	\$517	
<b>Equipment Rack Options - Buffet Height Credenzas:</b>			
Fixed Equipment Rack	Add <b>-R2</b>	\$906	Available for 24" deep Credenzas, behind the left most pair of doors
Sliding Equipment Rack	Add <b>-R1</b>	\$3,317	Available for 24" deep Credenzas, behind the left most pair of doors
<b>Waste/Recycling Unit Options:</b>			
Single Pull-Out Waste/Recycling Unit	Add <b>-TF1</b>	\$295	Available for 20" deep Credenzas only (Wall-Hung excluded), behind right most doors
Double Pull-Out Waste/Recycling Unit	Add <b>-TF2</b>	\$456	Available for 24" depth credenzas only (Wall-Hung excluded), behind right most doors





## GLOSS GLASS TOP

**REQUIRED INFORMATION (ORDER CANNOT BE ENTERED WITHOUT THIS INFORMATION):**

See pages vi-vii for surface material options.

- Choose Door Style: Defaults to case finish, if none selected
- Choose Metal Finish
- Choose Glass Finish
- Choose Paint Finish, if specified
- Choose Wood Species & Finish, if specified

**GENERAL INFORMATION**

- Glass is 1/4" -thick back-painted, low-iron glass
- Plank veneer is hand selected walnut veneers of varying character and color, with a clear coat finish, to accentuate the plank appearance
- When Plank veneer door style is specified with a veneer case, case and top will default to clear coat walnut in standard slip-match layup
- When veneer case is specified, the case exterior is standard slip-match layup regardless of veneer door style selection
- Pull-Out Waste/Recycling Bin size: 14" x 10-1/2" x 18"; (1) 36 Qt.; Double Pull-Out Waste/Recycling Units include two bins
- When lock option is specified, color will default based on leg finish:
  - Aged Bronze, Black, Galaxy, Shadow, and Storm: Black
  - Cloud: White
  - Burnish, Foil, and Satin Bronze: Satin Nickel
  - Chrome: Polished Nickel
- Credenzas include one adjustable shelf behind each door unless other components are specified
- Equipment racks hold 12RU and include a thermostatically controlled fan and plug strip



# GLOSS GLASS TOP

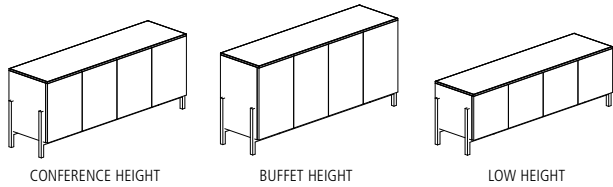

**CASE MATERIAL KEY**

PA-CB Painted Case with Cradle Base  
 V-CB Veneer Case with Cradle Base

**CRADLE BASE**

MODEL #	W x D x H	DESCRIPTION	-PA-CB	-V-CB
<b>CONFERENCE HEIGHT (23.5 IN. CASE WITH 6.5 IN. CRADLE BASE)</b>				
FWLC-3629-GG	36 x 20 x 30	Two Doors	6,585	7,199
FWLC-5429-GG	54 x 20 x 30	Three Doors	8,256	9,057
FWLC-7229-GG	72 x 20 x 30	Four Doors	9,932	10,918
FWLC-9029-GG	90 x 20 x 30	Five Doors	11,606	12,778
FWLD-3629-GG	36 x 24 x 30	Two Doors	7,140	7,814
FWLD-5429-GG	54 x 24 x 30	Three Doors	8,977	9,859
FWLD-7229-GG	72 x 24 x 30	Four Doors	10,818	11,905
FWLD-9029-GG	90 x 24 x 30	Five Doors	12,660	13,950
<b>BUFFET HEIGHT (28.5 IN. CASE WITH 6.5 IN. CRADLE BASE)</b>				
FWCC-3636-GG	36 x 20 x 35	Two Doors	7,028	7,690
FWCC-5436-GG	54 x 20 x 35	Three Doors	8,833	9,698
FWCC-7236-GG	72 x 20 x 35	Four Doors	10,640	11,708
FWCC-9036-GG	90 x 20 x 35	Five Doors	12,448	13,716
FWCD-3636-GG	36 x 24 x 35	Two Doors	7,625	8,354
FWCD-5436-GG	54 x 24 x 35	Three Doors	9,612	10,563
FWCD-7236-GG	72 x 24 x 35	Four Doors	11,601	12,773
FWCD-9036-GG	90 x 24 x 35	Five Doors	13,590	14,982
<b>LOW HEIGHT (17.5 IN. CASE WITH 6.5 IN. CRADLE BASE)</b>				
FWWC-3624-GG	36 x 20 x 24	Two Doors	6,129	6,694
FWWC-5424-GG	54 x 20 x 24	Three Doors	7,670	8,400
FWWC-7224-GG	72 x 20 x 24	Four Doors	9,201	10,107
FWWC-9024-GG	90 x 20 x 24	Five Doors	10,740	11,817

**DOOR STYLE**

DESCRIPTION	CODE	NOTES	PRICE
Plank Veneer	-PWD	Available in Clear Coat Walnut	\$301
Vertical Veneer	-VD		No Charge
Horizontal Veneer	-HD		No Charge
Veneer/Paint Combination	-VPD	Reference page 8 for predetermined accent door locations	No Charge
Painted	-PAD		No Charge

**OPTIONS**

	CODE	PRICE	NOTES
Locks	Add <b>-LK</b>	\$301	
Polished Chrome Base	Add <b>-PCCB</b>	\$1,698	
<b>Equipment Rack Options - Buffet Height Credenzas:</b>			
Fixed Equipment Rack	Add <b>-R2</b>	\$906	Available for 24" deep Credenzas, behind the left most pair of doors
Sliding Equipment Rack	Add <b>-R1</b>	\$3,317	Available for 24" deep Credenzas, behind the left most pair of doors
<b>Waste/Recycling Unit Options:</b>			
Single Pull-Out Waste/Recycling Unit	Add <b>-TF1</b>	\$295	Available for 20" deep Credenzas only (Wall-Hung excluded), behind right most doors
Double Pull-Out Waste/Recycling Unit	Add <b>-TF2</b>	\$456	Available for 24" depth credenzas only (Wall-Hung excluded), behind right most doors



# GLOSS GLASS TOP

**REQUIRED INFORMATION (ORDER CANNOT BE ENTERED WITHOUT THIS INFORMATION):**

See pages vi-vii for surface material options.

- Choose Door Style: Defaults to case finish, if none selected
- Choose Metal Finish
- Choose Glass Finish
- Choose Paint Finish, if specified
- Choose Wood Species & Finish, if specified

**GENERAL INFORMATION**

- Glass is 1/4" -thick back-painted, low-iron glass
- Plank veneer is hand selected walnut veneers of varying character and color, with a clear coat finish, to accentuate the plank appearance
- When Plank veneer door style is specified with a veneer case, case and top will default to clear coat walnut in standard slip-match layup
- When veneer case is specified, the case exterior is standard slip-match layup regardless of veneer door style selection
- Pull-Out Waste/Recycling Bin size: 14" x 10-1/2" x 18"; (1) 36 Qt.; Double Pull-Out Waste/Recycling Units include two bins
- When lock option is specified, color will default based on leg finish:
  - Aged Bronze, Black, Galaxy, Shadow, and Storm: Black
  - Cloud: White
  - Burnish, Foil, and Satin Bronze: Satin Nickel
  - Chrome: Polished Nickel
- Credenzas include one adjustable shelf behind each door unless other components are specified
- Equipment racks hold 12RU and include a thermostatically controlled fan and plug strip



# GLOSS GLASS TOP

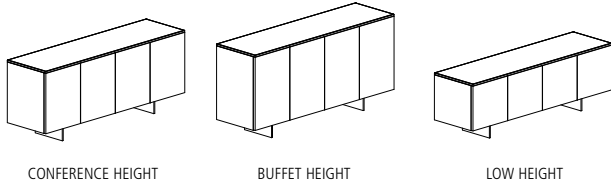

**CASE MATERIAL KEY**

PA-BB Painted Case with Blade Base  
 V-BB Veneer Case with Blade Base

**BLADE BASE**

MODEL #	W x D x H	DESCRIPTION	-PA-BB	-V-BB
<b>CONFERENCE HEIGHT (23.5 IN. CASE WITH 6.5 IN. BLADE LEG)</b>				
FWLC-3629-GG	36 x 20 x 30	Two Doors	6,286	6,902
FWLC-5429-GG	54 x 20 x 30	Three Doors	7,960	8,759
FWLC-7229-GG	72 x 20 x 30	Four Doors	9,633	10,621
FWLC-9029-GG	90 x 20 x 30	Five Doors	11,309	12,482
FWLD-3629-GG	36 x 24 x 30	Two Doors	6,842	7,516
FWLD-5429-GG	54 x 24 x 30	Three Doors	8,680	9,559
FWLD-7229-GG	72 x 24 x 30	Four Doors	10,522	11,608
FWLD-9029-GG	90 x 24 x 30	Five Doors	12,364	13,652
<b>BUFFET HEIGHT (28.5 IN. CASE WITH 6.5 IN. BLADE LEG)</b>				
FWCC-3636-GG	36 x 20 x 35	Two Doors	6,732	7,394
FWCC-5436-GG	54 x 20 x 35	Three Doors	8,537	9,403
FWCC-7236-GG	72 x 20 x 35	Four Doors	10,345	11,410
FWCC-9036-GG	90 x 20 x 35	Five Doors	12,152	13,419
FWCD-3636-GG	36 x 24 x 35	Two Doors	7,329	8,059
FWCD-5436-GG	54 x 24 x 35	Three Doors	9,315	10,266
FWCD-7236-GG	72 x 24 x 35	Four Doors	11,303	12,476
FWCD-9036-GG	90 x 24 x 35	Five Doors	13,293	14,686
<b>LOW HEIGHT (17.5 IN. CASE WITH 6.5 IN. BLADE LEG)</b>				
FWWC-3624-GG	36 x 20 x 24	Two Doors	5,093	6,395
FWWC-5424-GG	54 x 20 x 24	Three Doors	6,629	8,103
FWWC-7224-GG	72 x 20 x 24	Four Doors	8,163	9,812
FWWC-9024-GG	90 x 20 x 24	Five Doors	9,701	11,517

**DOOR STYLE**

DESCRIPTION	CODE	NOTES	PRICE
Plank Veneer	-PWD	Available in Clear Coat Walnut	\$301
Vertical Veneer	-VD		No Charge
Horizontal Veneer	-HD		No Charge
Veneer/Paint Combination	-VPD	Reference page 8 for predetermined accent door locations	No Charge
Painted	-PAD		No Charge

**OPTIONS**

OPTIONS	CODE	PRICE	NOTES
Locks	Add <b>-LK</b>	\$301	
Polished Chrome Base	Add <b>-PCBB</b>	\$479	
<b>Equipment Rack Options - Buffet Height Credenzas:</b>			
Fixed Equipment Rack	Add <b>-R2</b>	\$906	Available for 24" deep Credenzas, behind the left most pair of doors
Sliding Equipment Rack	Add <b>-R1</b>	\$3,317	Available for 24" deep Credenzas, behind the left most pair of doors
<b>Waste/Recycling Unit Options:</b>			
Single Pull-Out Waste/Recycling Unit	Add <b>-TF1</b>	\$295	Available for 20" deep Credenzas only (Wall-Hung excluded), behind right most doors
Double Pull-Out Waste/Recycling Unit	Add <b>-TF2</b>	\$456	Available for 24" depth credenzas only (Wall-Hung excluded), behind right most doors



# GLOSS GLASS TOP

**REQUIRED INFORMATION (ORDER CANNOT BE ENTERED WITHOUT THIS INFORMATION):**

See pages vi-vii for surface material options.

- Choose Door Style: Defaults to case finish, if none selected
- Choose Metal Finish
- Choose Glass Finish
- Choose Paint Finish, if specified
- Choose Wood Species & Finish, if specified

**GENERAL INFORMATION**

- Glass is 1/4" -thick back-painted, low-iron glass
- Plank veneer is hand selected walnut veneers of varying character and color, with a clear coat finish, to accentuate the plank appearance
- When Plank veneer door style is specified with a veneer case, case and top will default to clear coat walnut in standard slip-match layup
- When veneer case is specified, the case exterior is standard slip-match layup regardless of veneer door style selection
- Pull-Out Waste/Recycling Bin size: 14" x 10-1/2" x 18"; (1) 36 Qt.; Double Pull-Out Waste/Recycling Units include two bins
- When lock option is specified, color will default based on leg finish:
  - Aged Bronze, Black, Galaxy, Shadow, and Storm: Black
  - Cloud: White
  - Burnish, Foil, and Satin Bronze: Satin Nickel
  - Chrome: Polished Nickel
- Credenzas include one adjustable shelf behind each door unless other components are specified
- Equipment racks hold 12RU and include a thermostatically controlled fan and plug strip



# SATIN GLASS TOP

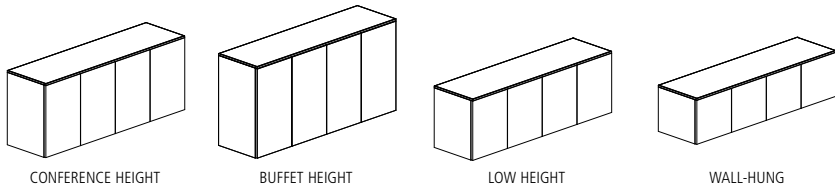

**CASE MATERIAL KEY**

PA Painted Case  
V Veneer Case

**CASE ONLY**

MODEL #	W x D x H	DESCRIPTION	-PA	-V
<b>CONFERENCE HEIGHT (29 INCH CASE)</b>				
FWCC-3629-SG	36 x 20 x 29	Two Doors	6,300	6,984
FWCC-5429-SG	54 x 20 x 29	Three Doors	8,202	9,091
FWCC-7229-SG	72 x 20 x 29	Four Doors	10,105	11,201
FWCC-9029-SG	90 x 20 x 29	Five Doors	12,007	13,310
FWCD-3629-SG	36 x 24 x 29	Two Doors	6,929	7,682
FWCD-5429-SG	54 x 24 x 29	Three Doors	9,022	10,001
FWCD-7229-SG	72 x 24 x 29	Four Doors	11,117	12,322
FWCD-9029-SG	90 x 24 x 29	Five Doors	13,206	14,640
<b>BUFFET HEIGHT (36 INCH CASE)</b>				
FWBC-3636-SG	36 x 20 x 36	Two Doors	7,245	8,029
FWBC-5436-SG	54 x 20 x 36	Three Doors	9,430	10,451
FWBC-7236-SG	72 x 20 x 36	Four Doors	11,616	12,879
FWBC-9036-SG	90 x 20 x 36	Five Doors	13,806	15,305
FWBD-3636-SG	36 x 24 x 36	Two Doors	7,968	8,831
FWBD-5436-SG	54 x 24 x 36	Three Doors	10,370	11,498
FWBD-7236-SG	72 x 24 x 36	Four Doors	12,780	14,165
FWBD-9036-SG	90 x 24 x 36	Five Doors	15,186	16,837
<b>LOW HEIGHT (24 INCH CASE)</b>				
FWLC-3624-SG	36 x 20 x 24	Two Doors	5,835	6,468
FWLC-5424-SG	54 x 20 x 24	Three Doors	7,595	8,419
FWLC-7224-SG	72 x 20 x 24	Four Doors	9,355	10,370
FWLC-9024-SG	90 x 20 x 24	Five Doors	11,119	12,327
FWLD-3624-SG	36 x 24 x 24	Two Doors	6,416	7,114
FWLD-5424-SG	54 x 24 x 24	Three Doors	8,353	9,260
FWLD-7224-SG	72 x 24 x 24	Four Doors	10,290	11,410
FWLD-9024-SG	90 x 24 x 24	Five Doors	12,229	13,558
<b>WALL-HUNG (17.5 INCH CASE)</b>				
FWWC-3618-SG	36 x 20 x 17.5	Two Doors	5,358	5,936
FWWC-5418-SG	54 x 20 x 17.5	Three Doors	6,977	7,731
FWWC-7218-SG	72 x 20 x 17.5	Four Doors	8,590	10,036
FWWC-9018-SG	90 x 20 x 17.5	Five Doors	10,208	11,316

**DOOR STYLE**

DESCRIPTION	CODE	NOTES	PRICE
Plank Veneer	-PWD	Available in Clear Coat Walnut	\$301
Vertical Veneer	-VD		No Charge
Horizontal Veneer	-HD	Reference page 8 for predetermined accent door locations	No Charge
Veneer/Paint Combination	-VPD		No Charge
Painted	-PAD		No Charge



# SATIN GLASS TOP

OPTIONS	CODE	PRICE	NOTES
Locks	Add <b>-LK</b>	\$301	
Drawers Behind Doors (Buffet Height - 36" Case Only)	Add <b>-D</b>	\$587	
<b>Equipment Rack Options - Conference Height and Buffet Height Credenzas:</b>			
Fixed Equipment Rack	Add <b>-R2</b>	\$906	Available for 24" deep Credenzas, behind the left most pair of doors
Sliding Equipment Rack	Add <b>-R1</b>	\$3,317	Available for 24" deep Credenzas, behind the left most pair of doors
<b>Waste/Recycling Unit Options:</b>			
Single Pull-Out Waste/Recycling Unit	Add <b>-TF1</b>	\$295	Available for 20" deep Credenzas only (Wall-Hung excluded), behind right most doors
Double Pull-Out Waste/Recycling Unit	Add <b>-TF2</b>	\$456	Available for 24" depth credenzas only (Wall-Hung excluded), behind right most doors

**REQUIRED INFORMATION (ORDER CANNOT BE ENTERED WITHOUT THIS INFORMATION):**

See pages vi-vii for surface material options.

- Choose Door Style: Defaults to case finish, if none selected
- Choose Glass Finish
- Choose Paint Finish, if specified
- Choose Wood Species & Finish, if specified

## GENERAL INFORMATION

- Glass is 1/4" -thick back-painted, low-iron glass
- Plank veneer is hand selected walnut veneers of varying character and color, with a clear coat finish, to accentuate the plank appearance
- When Plank veneer door style is specified with a veneer case, case and top will default to clear coat walnut in standard slip-match layup
- When veneer case is specified, the case exterior is standard slip-match layup regardless of veneer door style selection
- Pull-Out Waste/Recycling Bin size: 14" x 10-1/2" x 18"; (1) 36 Qt.; Double Pull-Out Waste/Recycling Units include two bins
- Locks
  - Veneer (Case Only) - When lock option is specified, color will default to Satin Nickel
  - Painted (Case Only) - When lock option is specified, color will default based on Paint finish:
    - Aged Bronze, Black, Galaxy, Shadow, and Storm: Black
    - Cloud: White
    - Burnish, Foil, Satin Bronze: Satin Nickel
    - Chrome: Polished Nickel
- Credenzas include one adjustable shelf behind each door unless other components are specified
- Equipment racks hold 12RU and include a thermostatically controlled fan and plug strip



# SATIN GLASS TOP

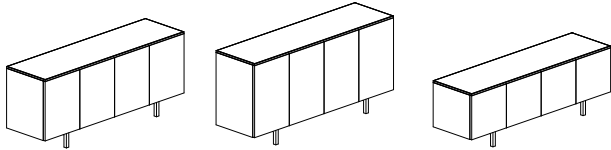

CONFERENCE HEIGHT

BUFFET HEIGHT

LOW HEIGHT

### CASE MATERIAL KEY

PA-IB Painted Case with Inset Leg  
 V-IB Veneer Case with Inset Leg

## INSET LEG

MODEL #	W x D x H	DESCRIPTION	-PA-IB	-V-IB
<b>CONFERENCE HEIGHT (23.5 IN. CASE WITH 6.5 IN. INSET LEG)</b>				
FWLC-3629-SG	36 x 20 x 30	Two Doors	6,279	6,912
FWLC-5429-SG	54 x 20 x 30	Three Doors	8,039	8,862
FWLC-7229-SG	72 x 20 x 30	Four Doors	9,799	10,814
FWLC-9029-SG	90 x 20 x 30	Five Doors	11,561	12,770
FWLD-3629-SG	36 x 24 x 30	Two Doors	6,864	7,559
FWLD-5429-SG	54 x 24 x 30	Three Doors	8,797	9,704
FWLD-7229-SG	72 x 24 x 30	Four Doors	10,736	11,854
FWLD-9029-SG	90 x 24 x 30	Five Doors	12,674	14,002
<b>BUFFET HEIGHT (28.5 IN. CASE WITH 6.5 IN. INSET LEG)</b>				
FWCC-3636-SG	36 x 20 x 35	Two Doors	6,746	7,430
FWCC-5436-SG	54 x 20 x 35	Three Doors	8,645	9,537
FWCC-7236-SG	72 x 20 x 35	Four Doors	10,549	11,646
FWCC-9036-SG	90 x 20 x 35	Five Doors	12,451	13,756
FWCD-3636-SG	36 x 24 x 35	Two Doors	7,375	8,127
FWCD-5436-SG	54 x 24 x 35	Three Doors	9,466	10,447
FWCD-7236-SG	72 x 24 x 35	Four Doors	11,560	12,766
FWCD-9036-SG	90 x 24 x 35	Five Doors	13,652	15,085
<b>LOW HEIGHT (17.5 IN. CASE WITH 6.5 IN. INSET LEG)</b>				
FWWC-3624-SG	36 x 20 x 24	Two Doors	5,803	6,382
FWWC-5424-SG	54 x 20 x 24	Three Doors	7,421	8,174
FWWC-7224-SG	72 x 20 x 24	Four Doors	9,036	10,482
FWWC-9024-SG	90 x 20 x 24	Five Doors	10,651	11,760

## DOOR STYLE

DESCRIPTION	CODE	NOTES	PRICE
Plank Veneer	-PWD	Available in Clear Coat Walnut	\$301
Vertical Veneer	-VD		No Charge
Horizontal Veneer	-HD		No Charge
Veneer/Paint Combination	-VPD	Reference page 8 for predetermined accent door locations	No Charge
Painted	-PAD		No Charge

### OPTIONS

	CODE	PRICE	NOTES
Locks	Add <b>-LK</b>	\$301	
Polished Chrome Base	Add <b>-PCIB</b>	\$479	
<b>Equipment Rack Options - Buffet Height Credenzas:</b>			
Fixed Equipment Rack	Add <b>-R2</b>	\$906	Available for 24" deep Credenzas, behind the left most pair of doors
Sliding Equipment Rack	Add <b>-R1</b>	\$3,317	Available for 24" deep Credenzas, behind the left most pair of doors
<b>Waste/Recycling Unit Options:</b>			
Single Pull-Out Waste/Recycling Unit	Add <b>-TF1</b>	\$295	Available for 20" deep Credenzas only (Wall-Hung excluded), behind right most doors
Double Pull-Out Waste/Recycling Unit	Add <b>-TF2</b>	\$456	Available for 24" deep credenzas only (Wall-Hung excluded), behind right most doors





# SATIN GLASS TOP

**REQUIRED INFORMATION (ORDER CANNOT BE ENTERED WITHOUT THIS INFORMATION):**

See pages vi-vii for surface material options.

- Choose Door Style: Defaults to case finish, if none selected
- Choose Metal Finish
- Choose Glass Finish
- Choose Paint Finish, if specified
- Choose Wood Species & Finish, if specified

**GENERAL INFORMATION**

- Glass is 1/4" -thick back-painted, low-iron glass
- Plank veneer is hand selected walnut veneers of varying character and color, with a clear coat finish, to accentuate the plank appearance
- When Plank veneer door style is specified with a veneer case, case and top will default to clear coat walnut in standard slip-match layup
- When veneer case is specified, the case exterior is standard slip-match layup regardless of veneer door style selection
- Pull-Out Waste/Recycling Bin size: 14" x 10-1/2" x 18"; (1) 36 Qt.; Double Pull-Out Waste/Recycling Units include two bins
- When lock option is specified, color will default based on leg finish:
  - Aged Bronze, Black, Galaxy, Shadow, and Storm: Black
  - Cloud: White
  - Burnish, Foil, and Satin Bronze: Satin Nickel
  - Chrome: Polished Nickel
- Credenzas include one adjustable shelf behind each door unless other components are specified
- Equipment racks hold 12RU and include a thermostatically controlled fan and plug strip



# SATIN GLASS TOP

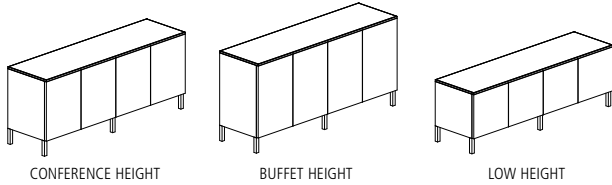

**CASE MATERIAL KEY**

PA-OB Painted Case with Edge-mount Post Leg  
 V-OB Veneer Case with Edge-mount Post Leg

**EDGE-MOUNT POST LEG**

MODEL #	W x D x H	DESCRIPTION	-PA-OB	-V-OB
<b>CONFERENCE HEIGHT (23.5 IN. CASE WITH 6.5 IN. EDGE-MOUNT POST LEG)</b>				
FWLC-3629-SG	36 x 20 x 30	Two Door	6,279	6,912
FWLC-5429-SG	54 x 20 x 30	Three Door	8,039	8,862
FWLC-7229-SG	72 x 20 x 30	Four Door	9,799	10,814
FWLC-9029-SG	90 x 20 x 30	Five Door	11,561	12,770
FWLD-3629-SG	36 x 24 x 30	Two Door	6,864	7,559
FWLD-5429-SG	54 x 24 x 30	Three Door	8,797	9,704
FWLD-7229-SG	72 x 24 x 30	Four Door	10,736	11,854
FWLD-9029-SG	90 x 24 x 30	Five Door	12,674	14,002
<b>BUFFET HEIGHT (28.5 IN. CASE WITH 6.5 IN. EDGE-MOUNT POST LEG)</b>				
FWCC-3636-SG	36 x 20 x 35	Two Door	6,746	7,430
FWCC-5436-SG	54 x 20 x 35	Three Door	8,645	9,537
FWCC-7236-SG	72 x 20 x 35	Four Door	10,549	11,646
FWCC-9036-SG	90 x 20 x 35	Five Door	12,451	13,756
FWCD-3636-SG	36 x 24 x 35	Two Door	7,375	8,127
FWCD-5436-SG	54 x 24 x 35	Three Door	9,466	10,447
FWCD-7236-SG	72 x 24 x 35	Four Door	11,560	12,766
FWCD-9036-SG	90 x 24 x 35	Five Door	13,652	15,085
<b>LOW HEIGHT (17.5 IN. CASE WITH 6.5 IN. EDGE-MOUNT POST LEG)</b>				
FWWC-3624-SG	36 x 20 x 24	Two Door	5,803	6,382
FWWC-5424-SG	54 x 20 x 24	Three Door	7,421	8,174
FWWC-7224-SG	72 x 20 x 24	Four Door	9,036	10,482
FWWC-9024-SG	90 x 20 x 24	Five Door	10,651	11,760

**DOOR STYLE**

DESCRIPTION	CODE	NOTES	PRICE
Plank Veneer	-PWD	Available in Clear Coat Walnut	\$301
Vertical Veneer	-VD		No Charge
Horizontal Veneer	-HD		No Charge
Veneer/Paint Combination	-VPD	Reference page 8 for predetermined accent door locations	No Charge
Painted	-PAD		No Charge

**OPTIONS**

	CODE	PRICE	NOTES
Locks	Add <b>-LK</b>	\$301	
Polished Chrome Base	Add <b>-PCOB</b>	\$517	
<b>Equipment Rack Options - Buffet Height Credenzas:</b>			
Fixed Equipment Rack	Add <b>-R2</b>	\$906	Available for 24" deep Credenzas, behind the left most pair of doors
Sliding Equipment Rack	Add <b>-R1</b>	\$3,317	Available for 24" deep Credenzas, behind the left most pair of doors
<b>Waste/Recycling Unit Options:</b>			
Single Pull-Out Waste/Recycling Unit	Add <b>-TF1</b>	\$295	Available for 20" deep Credenzas only (Wall-Hung excluded), behind right most doors
Double Pull-Out Waste/Recycling Unit	Add <b>-TF2</b>	\$456	Available for 24" depth credenzas only (Wall-Hung excluded), behind right most doors



# SATIN GLASS TOP

**REQUIRED INFORMATION (ORDER CANNOT BE ENTERED WITHOUT THIS INFORMATION):**

See pages vi-vii for surface material options.

- Choose Door Style: Defaults to case finish, if none selected
- Choose Metal Finish
- Choose Glass Finish
- Choose Paint Finish, if specified
- Choose Wood Species & Finish, if specified

**GENERAL INFORMATION**

- Glass is 1/4" -thick back-painted, low-iron glass
- Plank veneer is hand selected walnut veneers of varying character and color, with a clear coat finish, to accentuate the plank appearance
- When Plank veneer door style is specified with a veneer case, case and top will default to clear coat walnut in standard slip-match layup
- When veneer case is specified, the case exterior is standard slip-match layup regardless of veneer door style selection
- Pull-Out Waste/Recycling Bin size: 14" x 10-1/2" x 18"; (1) 36 Qt.; Double Pull-Out Waste/Recycling Units include two bins
- When lock option is specified, color will default based on leg finish:
  - Aged Bronze, Black, Galaxy, Shadow, and Storm: Black
  - Cloud: White
  - Burnish, Foil, and Satin Bronze: Satin Nickel
  - Chrome: Polished Nickel
- Credenzas include one adjustable shelf behind each door unless other components are specified
- Equipment racks hold 12RU and include a thermostatically controlled fan and plug strip



# SATIN GLASS TOP

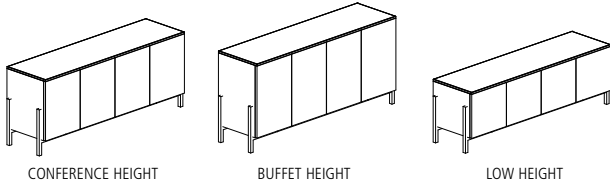

**CASE MATERIAL KEY**

PA-CB Painted Case with Cradle Base  
 V-CB Veneer Case with Cradle Base

**CRADLE BASE**

MODEL #	W x D x H	DESCRIPTION	-PA-CB	-V-CB
<b>CONFERENCE HEIGHT (23.5 IN. CASE WITH 6.5 IN. CRADLE BASE)</b>				
FWLC-3629-SG	36 x 20 x 30	Two Doors	6,874	7,507
FWLC-5429-SG	54 x 20 x 30	Three Doors	8,630	9,455
FWLC-7229-SG	72 x 20 x 30	Four Doors	10,391	11,408
FWLC-9029-SG	90 x 20 x 30	Five Doors	12,156	13,361
FWLD-3629-SG	36 x 24 x 30	Two Doors	7,456	8,152
FWLD-5429-SG	54 x 24 x 30	Three Doors	9,392	10,300
FWLD-7229-SG	72 x 24 x 30	Four Doors	11,330	12,447
FWLD-9029-SG	90 x 24 x 30	Five Doors	13,269	14,598
<b>BUFFET HEIGHT (28.5 IN. CASE WITH 6.5 IN. CRADLE BASE)</b>				
FWCC-3636-SG	36 x 20 x 35	Two Doors	7,338	8,024
FWCC-5436-SG	54 x 20 x 35	Three Doors	9,240	10,131
FWCC-7236-SG	72 x 20 x 35	Four Doors	11,144	12,239
FWCC-9036-SG	90 x 20 x 35	Five Doors	13,045	14,350
FWCD-3636-SG	36 x 24 x 35	Two Doors	7,968	8,722
FWCD-5436-SG	54 x 24 x 35	Three Doors	10,058	11,039
FWCD-7236-SG	72 x 24 x 35	Four Doors	12,152	13,359
FWCD-9036-SG	90 x 24 x 35	Five Doors	14,246	15,682
<b>LOW HEIGHT (17.5 IN. CASE WITH 6.5 IN. CRADLE BASE)</b>				
FWWC-3624-SG	36 x 20 x 24	Two Doors	6,394	6,977
FWWC-5424-SG	54 x 20 x 24	Three Doors	8,012	8,767
FWWC-7224-SG	72 x 20 x 24	Four Doors	9,629	11,074
FWWC-9024-SG	90 x 20 x 24	Five Doors	11,245	12,354

**DOOR STYLE**

DESCRIPTION	CODE	NOTES	PRICE
Plank Veneer	-PWD	Available in Clear Coat Walnut	\$301
Vertical Veneer	-VD		No Charge
Horizontal Veneer	-HD		No Charge
Veneer/Paint Combination	-VPD	Reference page 8 for predetermined accent door locations	No Charge
Painted	-PAD		No Charge

OPTIONS	CODE	PRICE	NOTES
Locks	Add <b>-LK</b>	\$301	
Polished Chrome Base	Add <b>-PCCB</b>	\$1,698	
<b>Equipment Rack Options - Buffet Height Credenzas:</b>			
Fixed Equipment Rack	Add <b>-R2</b>	\$906	Available for 24" deep Credenzas, behind the left most pair of doors
Sliding Equipment Rack	Add <b>-R1</b>	\$3,317	Available for 24" deep Credenzas, behind the left most pair of doors
<b>Waste/Recycling Unit Options:</b>			
Single Pull-Out Waste/Recycling Unit	Add <b>-TF1</b>	\$295	Available for 20" deep Credenzas only (Wall-Hung excluded), behind right most doors
Double Pull-Out Waste/Recycling Unit	Add <b>-TF2</b>	\$456	Available for 24" depth credenzas only (Wall-Hung excluded), behind right most doors



# SATIN GLASS TOP

**REQUIRED INFORMATION (ORDER CANNOT BE ENTERED WITHOUT THIS INFORMATION):**

See pages vi-vii for surface material options.

- Choose Door Style: Defaults to case finish, if none selected
- Choose Metal Finish
- Choose Glass Finish
- Choose Paint Finish, if specified
- Choose Wood Species & Finish, if specified

**GENERAL INFORMATION**

- Glass is 1/4" -thick back-painted, low-iron glass
- Plank veneer is hand selected walnut veneers of varying character and color, with a clear coat finish, to accentuate the plank appearance
- When Plank veneer door style is specified with a veneer case, case and top will default to clear coat walnut in standard slip-match layup
- When veneer case is specified, the case exterior is standard slip-match layup regardless of veneer door style selection
- Pull-Out Waste/Recycling Bin size: 14" x 10-1/2" x 18"; (1) 36 Qt.; Double Pull-Out Waste/Recycling Units include two bins
- When lock option is specified, color will default based on leg finish:
  - Aged Bronze, Black, Galaxy, Shadow, and Storm: Black
  - Cloud: White
  - Burnish, Foil, and Satin Bronze: Satin Nickel
  - Chrome: Polished Nickel
- Credenzas include one adjustable shelf behind each door unless other components are specified
- Equipment racks hold 12RU and include a thermostatically controlled fan and plug strip



# SATIN GLASS TOP

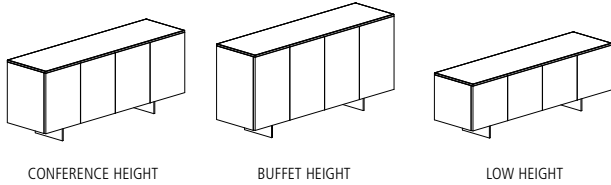

**CASE MATERIAL KEY**

PA-BB Painted Case with Blade Base  
 V-BB Veneer Case with Blade Base

**BLADE BASE**

MODEL #	W x D x H	DESCRIPTION	-PA-BB	-V-BB
<b>CONFERENCE HEIGHT (23.5 IN. CASE WITH 6.5 IN. BLADE LEG)</b>				
FWLC-3629-SG	36 x 20 x 30	Two Doors	6,576	7,210
FWLC-5429-SG	54 x 20 x 30	Three Doors	8,335	9,161
FWLC-7229-SG	72 x 20 x 30	Four Doors	10,095	11,110
FWLC-9029-SG	90 x 20 x 30	Five Doors	11,859	13,064
FWLD-3629-SG	36 x 24 x 30	Two Doors	7,160	7,856
FWLD-5429-SG	54 x 24 x 30	Three Doors	9,093	10,003
FWLD-7229-SG	72 x 24 x 30	Four Doors	11,033	12,151
FWLD-9029-SG	90 x 24 x 30	Five Doors	12,971	14,300
<b>BUFFET HEIGHT (28.5 IN. CASE WITH 6.5 IN. BLADE LEG)</b>				
FWCC-3636-SG	36 x 20 x 35	Two Doors	7,043	7,726
FWCC-5436-SG	54 x 20 x 35	Three Doors	8,941	9,836
FWCC-7236-SG	72 x 20 x 35	Four Doors	10,847	11,943
FWCC-9036-SG	90 x 20 x 35	Five Doors	12,749	14,052
FWCD-3636-SG	36 x 24 x 35	Two Doors	7,673	8,423
FWCD-5436-SG	54 x 24 x 35	Three Doors	9,763	10,743
FWCD-7236-SG	72 x 24 x 35	Four Doors	11,855	13,062
FWCD-9036-SG	90 x 24 x 35	Five Doors	13,950	15,382
<b>LOW HEIGHT (17.5 IN. CASE WITH 6.5 IN. BLADE LEG)</b>				
FWWC-3624-SG	36 x 20 x 24	Two Doors	6,100	6,678
FWWC-5424-SG	54 x 20 x 24	Three Doors	7,715	8,471
FWWC-7224-SG	72 x 20 x 24	Four Doors	9,332	10,778
FWWC-9024-SG	90 x 20 x 24	Five Doors	10,948	12,059

**DOOR STYLE**

DESCRIPTION	CODE	NOTES	PRICE
Plank Veneer	-PWD	Available in Clear Coat Walnut	\$301
Vertical Veneer	-VD		No Charge
Horizontal Veneer	-HD		No Charge
Veneer/Paint Combination	-VPD	Reference page 8 for predetermined accent door locations	No Charge
Painted	-PAD		No Charge

**OPTIONS**

OPTIONS	CODE	PRICE	NOTES
Locks	Add <b>-LK</b>	\$301	
Polished Chrome Base	Add <b>-PCBB</b>	\$479	
<b>Equipment Rack Options - Buffet Height Credenzas:</b>			
Fixed Equipment Rack	Add <b>-R2</b>	\$906	Available for 24" deep Credenzas, behind the left most pair of doors
Sliding Equipment Rack	Add <b>-R1</b>	\$3,317	Available for 24" deep Credenzas, behind the left most pair of doors
<b>Waste/Recycling Unit Options:</b>			
Single Pull-Out Waste/Recycling Unit	Add <b>-TF1</b>	\$295	Available for 20" deep Credenzas only (Wall-Hung excluded), behind right most doors
Double Pull-Out Waste/Recycling Unit	Add <b>-TF2</b>	\$456	Available for 24" depth credenzas only (Wall-Hung excluded), behind right most doors



# SATIN GLASS TOP

**REQUIRED INFORMATION (ORDER CANNOT BE ENTERED WITHOUT THIS INFORMATION):**

See pages vi-vii for surface material options.

- Choose Door Style: Defaults to case finish, if none selected
- Choose Metal Finish
- Choose Glass Finish
- Choose Paint Finish, if specified
- Choose Wood Species & Finish, if specified

**GENERAL INFORMATION**

- Glass is 1/4" -thick back-painted, low-iron glass
- Plank veneer is hand selected walnut veneers of varying character and color, with a clear coat finish, to accentuate the plank appearance
- When Plank veneer door style is specified with a veneer case, case and top will default to clear coat walnut in standard slip-match layup
- When veneer case is specified, the case exterior is standard slip-match layup regardless of veneer door style selection
- Pull-Out Waste/Recycling Bin size: 14" x 10-1/2" x 18"; (1) 36 Qt.; Double Pull-Out Waste/Recycling Units include two bins
- When lock option is specified, color will default based on leg finish:
  - Aged Bronze, Black, Galaxy, Shadow, and Storm: Black
  - Cloud: White
  - Burnish, Foil, and Satin Bronze: Satin Nickel
  - Chrome: Polished Nickel
- Credenzas include one adjustable shelf behind each door unless other components are specified
- Equipment racks hold 12RU and include a thermostatically controlled fan and plug strip



# STONE TOP

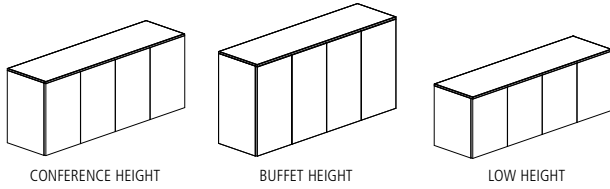

**CASE MATERIAL KEY**

PA Painted Case  
V Veneer Case

**CASE ONLY**

MODEL #	W x D x H	DESCRIPTION	-PA	-V
<b>CONFERENCE HEIGHT (29.5 INCH CASE)</b>				
FWCC-3629-S	36 x 20 x 29.5	Two Doors	7,030	7,808
FWCC-5429-S	54 x 20 x 29.5	Three Doors	9,149	10,162
FWCC-7229-S	72 x 20 x 29.5	Four Doors	11,273	12,524
FWCC-9029-S	90 x 20 x 29.5	Five Doors	13,397	14,882
FWCD-3629-S	36 x 24 x 29.5	Two Doors	7,732	8,590
FWCD-5429-S	54 x 24 x 29.5	Three Doors	10,066	11,184
FWCD-7229-S	72 x 24 x 29.5	Four Doors	12,400	13,775
FWCD-9029-S	90 x 24 x 29.5	Five Doors	14,734	16,369
<b>BUFFET HEIGHT (36.5 INCH CASE)</b>				
FWBC-3636-S	36 x 20 x 36.5	Two Doors	8,083	8,975
FWBC-5436-S	54 x 20 x 36.5	Three Doors	10,519	11,685
FWBC-7236-S	72 x 20 x 36.5	Four Doors	12,962	14,401
FWBC-9036-S	90 x 20 x 36.5	Five Doors	15,402	17,111
FWBD-3636-S	36 x 24 x 36.5	Two Doors	8,890	9,872
FWBD-5436-S	54 x 24 x 36.5	Three Doors	11,570	12,855
FWBD-7236-S	72 x 24 x 36.5	Four Doors	14,257	15,840
FWBD-9036-S	90 x 24 x 36.5	Five Doors	16,941	18,822
<b>LOW HEIGHT (24.5 INCH CASE)</b>				
FWLC-3624-S	36 x 20 x 24.5	Two Doors	6,509	7,232
FWLC-5424-S	54 x 20 x 24.5	Three Doors	8,472	9,412
FWLC-7224-S	72 x 20 x 24.5	Four Doors	10,437	11,598
FWLC-9024-S	90 x 20 x 24.5	Five Doors	12,405	13,779
FWLD-3624-S	36 x 24 x 24.5	Two Doors	7,160	7,955
FWLD-5424-S	54 x 24 x 24.5	Three Doors	9,320	10,354
FWLD-7224-S	72 x 24 x 24.5	Four Doors	11,481	12,757
FWLD-9024-S	90 x 24 x 24.5	Five Doors	13,642	15,158

**DOOR STYLE**

DESCRIPTION	CODE	NOTES	PRICE
Plank Veneer	-PWD	Available in Clear Coat Walnut	\$301
Vertical Veneer	-VD		No Charge
Horizontal Veneer	-HD		No Charge
Veneer/Paint Combination	-VPD	Reference page 8 for predetermined accent door locations	No Charge
Painted	-PAD		No Charge





# STONE TOP

OPTIONS	CODE	PRICE	NOTES
Locks	Add <b>-LK</b>	\$301	
Drawers Behind Doors (Buffet Height - 36" Case Only)	Add <b>-D</b>	\$587	
<b>Equipment Rack Options - Conference Height and Buffet Height Credenzas:</b>			
Fixed Equipment Rack	Add <b>-R2</b>	\$906	Available for 24" deep Credenzas, behind the left most pair of doors
Sliding Equipment Rack	Add <b>-R1</b>	\$3,317	Available for 24" deep Credenzas, behind the left most pair of doors
<b>Waste/Recycling Unit Options:</b>			
Single Pull-Out Waste/Recycling Unit	Add <b>-TF1</b>	\$295	Available for 20" deep Credenzas only (Wall-Hung excluded), behind right most doors
Double Pull-Out Waste/Recycling Unit	Add <b>-TF2</b>	\$456	Available for 24" depth credenzas only (Wall-Hung excluded), behind right most doors

**REQUIRED INFORMATION (ORDER CANNOT BE ENTERED WITHOUT THIS INFORMATION):**

See pages vi-vii for surface material options.

- Choose Door Style: Defaults to case finish, if none selected
- Choose Stone Finish
- Choose Paint Finish, if specified
- Choose Wood Species & Finish, if specified

## GENERAL INFORMATION

- Stone/Quartz tops are 2cm thick
- Plank veneer is hand selected walnut veneers of varying character and color, with a clear coat finish, to accentuate the plank appearance
- When Plank veneer door style is specified with a veneer case, case and top will default to clear coat walnut in standard slip-match layout
- When veneer case is specified, the case exterior is standard slip-match layout regardless of veneer door style selection
- Pull-Out Waste/Recycling Bin size: 14" x 10-1/2" x 18"; (1) 36 Qt.; Double Pull-Out Waste/Recycling Units include two bins
- Locks
  - Veneer (Case Only) - When lock option is specified, color will default to Satin Nickel
  - Painted (Case Only) - When lock option is specified, color will default based on Paint finish:
    - Aged Bronze, Black, Galaxy, Shadow, and Storm: Black
    - Cloud: White
    - Burnish, Foil, Satin Bronze: Satin Nickel
    - Chrome: Polished Nickel
- Credenzas include one adjustable shelf behind each door unless other components are specified
- Equipment racks hold 12RU and include a thermostatically controlled fan and plug strip



# STONE TOP

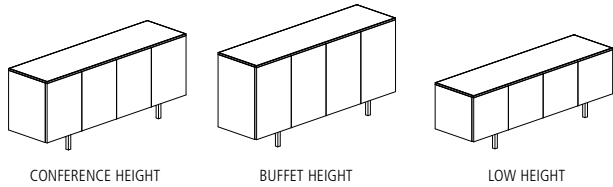

**CASE MATERIAL KEY**

PA-IB Painted Case with Inset Leg  
 V-IB Veneer Case with Inset Leg

**INSET LEG**

MODEL #	W x D x H	DESCRIPTION	-PA-IB	-V-IB
<b>CONFERENCE HEIGHT (24 IN. CASE WITH 6.5 IN. INSET LEG)</b>				
FWLC-3629-S	36 x 20 x 30.5	Two Doors	6,952	7,676
FWLC-5429-S	54 x 20 x 30.5	Three Doors	8,918	9,858
FWLC-7229-S	72 x 20 x 30.5	Four Doors	10,883	12,041
FWLC-9029-S	90 x 20 x 30.5	Five Doors	12,848	14,225
FWLD-3629-S	36 x 24 x 30.5	Two Doors	7,603	8,400
FWLD-5429-S	54 x 24 x 30.5	Three Doors	9,764	10,800
FWLD-7229-S	72 x 24 x 30.5	Four Doors	11,925	13,202
FWLD-9029-S	90 x 24 x 30.5	Five Doors	14,088	15,604
<b>BUFFET HEIGHT (29 IN. CASE WITH 6.5 IN. INSET LEG)</b>				
FWCC-3636-S	36 x 20 x 35.5	Two Doors	7,474	8,254
FWCC-5436-S	54 x 20 x 35.5	Three Doors	9,596	10,610
FWCC-7236-S	72 x 20 x 35.5	Four Doors	11,718	12,969
FWCC-9036-S	90 x 20 x 35.5	Five Doors	13,841	15,327
FWCD-3636-S	36 x 24 x 35.5	Two Doors	8,175	9,036
FWCD-5436-S	54 x 24 x 35.5	Three Doors	10,511	11,626
FWCD-7236-S	72 x 24 x 35.5	Four Doors	12,842	14,220
FWCD-9036-S	90 x 24 x 35.5	Five Doors	15,180	16,815
<b>LOW HEIGHT (18 IN. CASE WITH 6.5 IN. INSET LEG)</b>				
FWWC-3624-S	36 x 20 x 24.5	Two Doors	6,419	7,084
FWWC-5424-S	54 x 20 x 24.5	Three Doors	8,228	9,089
FWWC-7224-S	72 x 20 x 24.5	Four Doors	10,026	11,091
FWWC-9024-S	90 x 20 x 24.5	Five Doors	11,832	13,095

**DOOR STYLE**

DESCRIPTION	CODE	NOTES	PRICE
Plank Veneer	-PWD	Available in Clear Coat Walnut	\$301
Vertical Veneer	-VD		No Charge
Horizontal Veneer	-HD		No Charge
Veneer/Paint Combination	-VPD	Reference page 8 for predetermined accent door locations	No Charge
Painted	-PAD		No Charge

**OPTIONS**

	CODE	PRICE	NOTES
Locks	Add <b>-LK</b>	\$301	
Polished Chrome Base	Add <b>-PCIB</b>	\$479	
<b>Equipment Rack Options - Buffet Height Credenzas:</b>			
Fixed Equipment Rack	Add <b>-R2</b>	\$906	Available for 24" deep Credenzas, behind the left most pair of doors
Sliding Equipment Rack	Add <b>-R1</b>	\$3,317	Available for 24" deep Credenzas, behind the left most pair of doors
<b>Waste/Recycling Unit Options:</b>			
Single Pull-Out Waste/Recycling Unit	Add <b>-TF1</b>	\$295	Available for 20" deep Credenzas only (Wall-Hung excluded), behind right most doors
Double Pull-Out Waste/Recycling Unit	Add <b>-TF2</b>	\$456	Available for 24" depth credenzas only (Wall-Hung excluded), behind right most doors



# STONE TOP

**REQUIRED INFORMATION (ORDER CANNOT BE ENTERED WITHOUT THIS INFORMATION):**

See pages vi-vii for surface material options.

- Choose Door Style: Defaults to case finish, if none selected
- Choose Metal Finish
- Choose Stone Finish
- Choose Paint Finish, if specified
- Choose Wood Species & Finish, if specified

**GENERAL INFORMATION**

- Stone/Quartz tops are 2cm thick
- Plank veneer is hand selected walnut veneers of varying character and color, with a clear coat finish, to accentuate the plank appearance
- When Plank veneer door style is specified with a veneer case, case and top will default to clear coat walnut in standard slip-match layup
- When veneer case is specified, the case exterior is standard slip-match layup regardless of veneer door style selection
- Pull-Out Waste/Recycling Bin size: 14" x 10-1/2" x 18"; (1) 36 Qt.; Double Pull-Out Waste/Recycling Units include two bins
- When lock option is specified, color will default based on leg finish:
  - Aged Bronze, Black, Galaxy, Shadow, and Storm: Black
  - Cloud: White
  - Burnish, Foil, and Satin Bronze: Satin Nickel
  - Chrome: Polished Nickel
- Credenzas include one adjustable shelf behind each door unless other components are specified
- Equipment racks hold 12RU and include a thermostatically controlled fan and plug strip



# STONE TOP

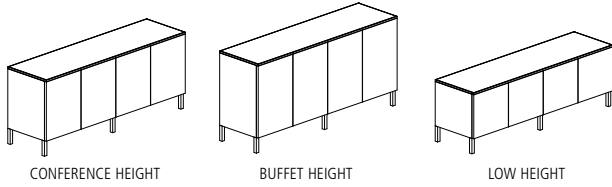

**CASE MATERIAL KEY**

PA-OB Painted Case with Edge-mount Post Leg  
 V-OB Veneer Case with Edge-mount Post Leg

**EDGE-MOUNT POST LEG**

MODEL #	W x D x H	DESCRIPTION	-PA-OB	-V-OB
<b>CONFERENCE HEIGHT (24 IN. CASE WITH 6.5 IN. EDGE-MOUNT POST LEG)</b>				
FWLC-3629-S	36 x 20 x 30.5	Two Door	6,952	7,676
FWLC-5429-S	54 x 20 x 30.5	Three Door	8,918	9,858
FWLC-7229-S	72 x 20 x 30.5	Four Door	10,883	12,041
FWLC-9029-S	90 x 20 x 30.5	Five Door	12,848	14,225
FWLD-3629-S	36 x 24 x 30.5	Two Door	7,603	8,400
FWLD-5429-S	54 x 24 x 30.5	Three Door	9,764	10,800
FWLD-7229-S	72 x 24 x 30.5	Four Door	11,925	13,202
FWLD-9029-S	90 x 24 x 30.5	Five Door	14,088	15,604
<b>BUFFET HEIGHT (29 IN. CASE WITH 6.5 IN. EDGE-MOUNT POST LEG)</b>				
FWCC-3636-S	36 x 20 x 35.5	Two Door	7,474	8,254
FWCC-5436-S	54 x 20 x 35.5	Three Door	9,596	10,610
FWCC-7236-S	72 x 20 x 35.5	Four Door	11,718	12,969
FWCC-9036-S	90 x 20 x 35.5	Five Door	13,841	15,327
FWCD-3636-S	36 x 24 x 35.5	Two Door	8,175	9,036
FWCD-5436-S	54 x 24 x 35.5	Three Door	10,511	11,626
FWCD-7236-S	72 x 24 x 35.5	Four Door	12,842	14,220
FWCD-9036-S	90 x 24 x 35.5	Five Door	15,180	16,815
<b>LOW HEIGHT (18 IN. CASE WITH 6.5 IN. EDGE-MOUNT POST LEG)</b>				
FWWC-3624-S	36 x 20 x 24.5	Two Door	6,419	7,084
FWWC-5424-S	54 x 20 x 24.5	Three Door	8,228	9,089
FWWC-7224-S	72 x 20 x 24.5	Four Door	10,026	11,091
FWWC-9024-S	90 x 20 x 24.5	Five Door	11,832	13,095

**DOOR STYLE**

DESCRIPTION	CODE	NOTES	PRICE
Plank Veneer	-PWD	Available in Clear Coat Walnut	\$301
Vertical Veneer	-VD		No Charge
Horizontal Veneer	-HD		No Charge
Veneer/Paint Combination	-VPD	Reference page 8 for predetermined accent door locations	No Charge
Painted	-PAD		No Charge

OPTIONS	CODE	PRICE	NOTES
Locks	Add <b>-LK</b>	\$301	
Polished Chrome Base	Add <b>-PCOB</b>	\$517	
<b>Equipment Rack Options - Buffet Height Credenzas:</b>			
Fixed Equipment Rack	Add <b>-R2</b>	\$906	Available for 24" deep Credenzas, behind the left most pair of doors
Sliding Equipment Rack	Add <b>-R1</b>	\$3,317	Available for 24" deep Credenzas, behind the left most pair of doors
<b>Waste/Recycling Unit Options:</b>			
Single Pull-Out Waste/Recycling Unit	Add <b>-TF1</b>	\$295	Available for 20" deep Credenzas only (Wall-Hung excluded), behind right most doors
Double Pull-Out Waste/Recycling Unit	Add <b>-TF2</b>	\$456	Available for 24" depth credenzas only (Wall-Hung excluded), behind right most doors



# STONE TOP

**REQUIRED INFORMATION (ORDER CANNOT BE ENTERED WITHOUT THIS INFORMATION):**

See pages vi-vii for surface material options.

- Choose Door Style: Defaults to case finish, if none selected
- Choose Metal Finish
- Choose Stone Finish
- Choose Paint Finish, if specified
- Choose Wood Species & Finish, if specified

**GENERAL INFORMATION**

- Stone/Quartz tops are 2cm thick
- Plank veneer is hand selected walnut veneers of varying character and color, with a clear coat finish, to accentuate the plank appearance
- When Plank veneer door style is specified with a veneer case, case and top will default to clear coat walnut in standard slip-match layup
- When veneer case is specified, the case exterior is standard slip-match layup regardless of veneer door style selection
- Pull-Out Waste/Recycling Bin size: 14" x 10-1/2" x 18"; (1) 36 Qt.; Double Pull-Out Waste/Recycling Units include two bins
- When lock option is specified, color will default based on leg finish:
  - Aged Bronze, Black, Galaxy, Shadow, and Storm: Black
  - Cloud: White
  - Burnish, Foil, and Satin Bronze: Satin Nickel
  - Chrome: Polished Nickel
- Credenzas include one adjustable shelf behind each door unless other components are specified
- Equipment racks hold 12RU and include a thermostatically controlled fan and plug strip



# STONE TOP

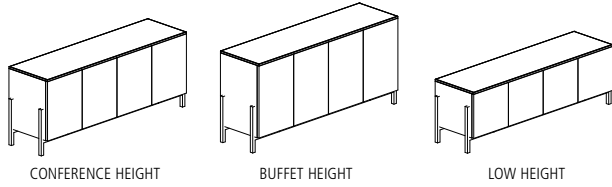

**CASE MATERIAL KEY**

PA-CB Painted Case with Cradle Base  
 V-CB Veneer Case with Cradle Base

**CRADLE BASE**

MODEL #	W x D x H	DESCRIPTION	-PA-CB	-V-CB
<b>CONFERENCE HEIGHT (24 IN. CASE WITH 6.5 IN. CRADLE BASE)</b>				
FWLC-3629-S	36 x 20 x 30.5	Two Doors	7,548	8,270
FWLC-5429-S	54 x 20 x 30.5	Three Doors	9,513	10,450
FWLC-7229-S	72 x 20 x 30.5	Four Doors	11,476	12,634
FWLC-9029-S	90 x 20 x 30.5	Five Doors	13,442	14,817
FWLD-3629-S	36 x 24 x 30.5	Two Doors	8,200	8,993
FWLD-5429-S	54 x 24 x 30.5	Three Doors	10,357	11,393
FWLD-7229-S	72 x 24 x 30.5	Four Doors	12,520	13,796
FWLD-9029-S	90 x 24 x 30.5	Five Doors	14,682	16,196
<b>BUFFET HEIGHT (29 IN. CASE WITH 6.5 IN. CRADLE BASE)</b>				
FWCC-3636-S	36 x 20 x 35.5	Two Doors	8,067	8,847
FWCC-5436-S	54 x 20 x 35.5	Three Doors	10,188	11,202
FWCC-7236-S	72 x 20 x 35.5	Four Doors	12,311	13,562
FWCC-9036-S	90 x 20 x 35.5	Five Doors	14,433	15,919
FWCD-3636-S	36 x 24 x 35.5	Two Doors	8,769	9,629
FWCD-5436-S	54 x 24 x 35.5	Three Doors	11,101	12,220
FWCD-7236-S	72 x 24 x 35.5	Four Doors	13,438	14,814
FWCD-9036-S	90 x 24 x 35.5	Five Doors	15,773	17,409
<b>LOW HEIGHT (18 IN. CASE WITH 6.5 IN. CRADLE BASE)</b>				
FWWC-3624-S	36 x 20 x 24.5	Two Doors	7,013	7,677
FWWC-5424-S	54 x 20 x 24.5	Three Doors	8,822	9,683
FWWC-7224-S	72 x 20 x 24.5	Four Doors	10,621	11,685
FWWC-9024-S	90 x 20 x 24.5	Five Doors	12,424	13,690

**DOOR STYLE**

DESCRIPTION	CODE	NOTES	PRICE
Plank Veneer	-PWD	Available in Clear Coat Walnut	\$301
Vertical Veneer	-VD		No Charge
Horizontal Veneer	-HD		No Charge
Veneer/Paint Combination	-VPD	Reference page 8 for predetermined accent door locations	No Charge
Painted	-PAD		No Charge

**OPTIONS**

	CODE	PRICE	NOTES
Locks	Add <b>-LK</b>	\$301	
Polished Chrome Base	Add <b>-PCCB</b>	\$1,698	
<b>Equipment Rack Options - Buffet Height Credenzas:</b>			
Fixed Equipment Rack	Add <b>-R2</b>	\$906	Available for 24" deep Credenzas, behind the left most pair of doors
Sliding Equipment Rack	Add <b>-R1</b>	\$3,317	Available for 24" deep Credenzas, behind the left most pair of doors
<b>Waste/Recycling Unit Options:</b>			
Single Pull-Out Waste/Recycling Unit	Add <b>-TF1</b>	\$295	Available for 20" deep Credenzas only (Wall-Hung excluded), behind right most doors
Double Pull-Out Waste/Recycling Unit	Add <b>-TF2</b>	\$456	Available for 24" depth credenzas only (Wall-Hung excluded), behind right most doors



# STONE TOP

**REQUIRED INFORMATION (ORDER CANNOT BE ENTERED WITHOUT THIS INFORMATION):**

See pages vi-vii for surface material options.

- Choose Door Style: Defaults to case finish, if none selected
- Choose Metal Finish
- Choose Stone Finish
- Choose Paint Finish, if specified
- Choose Wood Species & Finish, if specified

**GENERAL INFORMATION**

- Stone/Quartz tops are 2cm thick
- Plank veneer is hand selected walnut veneers of varying character and color, with a clear coat finish, to accentuate the plank appearance
- When Plank veneer door style is specified with a veneer case, case and top will default to clear coat walnut in standard slip-match layup
- When veneer case is specified, the case exterior is standard slip-match layup regardless of veneer door style selection
- Pull-Out Waste/Recycling Bin size: 14" x 10-1/2" x 18"; (1) 36 Qt.; Double Pull-Out Waste/Recycling Units include two bins
- When lock option is specified, color will default based on leg finish:
  - Aged Bronze, Black, Galaxy, Shadow, and Storm: Black
  - Cloud: White
  - Burnish, Foil, and Satin Bronze: Satin Nickel
  - Chrome: Polished Nickel
- Credenzas include one adjustable shelf behind each door unless other components are specified
- Equipment racks hold 12RU and include a thermostatically controlled fan and plug strip



# STONE TOP

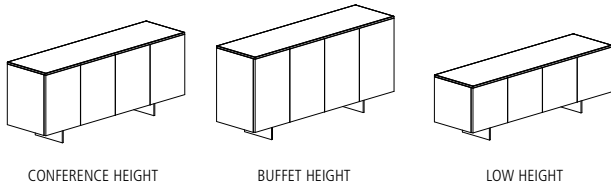

**CASE MATERIAL KEY**

PA-BB Painted Case with Blade Base  
 V-BB Veneer Case with Blade Base

**BLADE BASE**

MODEL #	W x D x H	DESCRIPTION	-PA-BB	-V-BB
<b>CONFERENCE HEIGHT (24 IN. CASE WITH 6.5 IN. BLADE LEG)</b>				
FWLC-3629-S	36 x 20 x 30.5	Two Doors	7,250	7,972
FWLC-5429-S	54 x 20 x 30.5	Three Doors	9,215	10,153
FWLC-7229-S	72 x 20 x 30.5	Four Doors	11,179	12,339
FWLC-9029-S	90 x 20 x 30.5	Five Doors	13,145	14,522
FWLD-3629-S	36 x 24 x 30.5	Two Doors	7,902	8,695
FWLD-5429-S	54 x 24 x 30.5	Three Doors	10,064	11,096
FWLD-7229-S	72 x 24 x 30.5	Four Doors	12,224	13,497
FWLD-9029-S	90 x 24 x 30.5	Five Doors	14,386	15,899
<b>BUFFET HEIGHT (29 IN. CASE WITH 6.5 IN. BLADE LEG)</b>				
FWCC-3636-S	36 x 20 x 35.5	Two Doors	7,772	8,549
FWCC-5436-S	54 x 20 x 35.5	Three Doors	9,892	10,905
FWCC-7236-S	72 x 20 x 35.5	Four Doors	12,015	13,268
FWCC-9036-S	90 x 20 x 35.5	Five Doors	14,138	15,621
FWCD-3636-S	36 x 24 x 35.5	Two Doors	8,472	9,332
FWCD-5436-S	54 x 24 x 35.5	Three Doors	10,805	11,923
FWCD-7236-S	72 x 24 x 35.5	Four Doors	13,142	14,519
FWCD-9036-S	90 x 24 x 35.5	Five Doors	15,477	17,112
<b>LOW HEIGHT (18 IN. CASE WITH 6.5 IN. BLADE LEG)</b>				
FWWC-3624-S	36 x 20 x 24.5	Two Doors	6,717	7,380
FWWC-5424-S	54 x 20 x 24.5	Three Doors	8,524	9,385
FWWC-7224-S	72 x 20 x 24.5	Four Doors	10,325	11,390
FWWC-9024-S	90 x 20 x 24.5	Five Doors	12,129	13,392

**DOOR STYLE**

DESCRIPTION	CODE	NOTES	PRICE
Plank Veneer	-PWD	Available in Clear Coat Walnut	\$301
Vertical Veneer	-VD		No Charge
Horizontal Veneer	-HD		No Charge
Veneer/Paint Combination	-VPD	Reference page 8 for predetermined accent door locations	No Charge
Painted	-PAD		No Charge

**OPTIONS**

OPTIONS	CODE	PRICE	NOTES
Locks	Add <b>-LK</b>	\$301	
Polished Chrome Base	Add <b>-PCBB</b>	\$479	
<b>Equipment Rack Options - Buffet Height Credenzas:</b>			
Fixed Equipment Rack	Add <b>-R2</b>	\$906	Available for 24" deep Credenzas, behind the left most pair of doors
Sliding Equipment Rack	Add <b>-R1</b>	\$3,317	Available for 24" deep Credenzas, behind the left most pair of doors
<b>Waste/Recycling Unit Options:</b>			
Single Pull-Out Waste/Recycling Unit	Add <b>-TF1</b>	\$295	Available for 20" deep Credenzas only (Wall-Hung excluded), behind right most doors
Double Pull-Out Waste/Recycling Unit	Add <b>-TF2</b>	\$456	Available for 24" depth credenzas only (Wall-Hung excluded), behind right most doors





# STONE TOP

**REQUIRED INFORMATION (ORDER CANNOT BE ENTERED WITHOUT THIS INFORMATION):**

See pages vi-vii for surface material options.

- Choose Door Style: Defaults to case finish, if none selected
- Choose Metal Finish
- Choose Stone Finish
- Choose Paint Finish, if specified
- Choose Wood Species & Finish, if specified

**GENERAL INFORMATION**

- Stone/Quartz tops are 2cm thick
- Plank veneer is hand selected walnut veneers of varying character and color, with a clear coat finish, to accentuate the plank appearance
- When Plank veneer door style is specified with a veneer case, case and top will default to clear coat walnut in standard slip-match layup
- When veneer case is specified, the case exterior is standard slip-match layup regardless of veneer door style selection
- Pull-Out Waste/Recycling Bin size: 14" x 10-1/2" x 18"; (1) 36 Qt.; Double Pull-Out Waste/Recycling Units include two bins
- When lock option is specified, color will default based on leg finish:
  - Aged Bronze, Black, Galaxy, Shadow, and Storm: Black
  - Cloud: White
  - Burnish, Foil, and Satin Bronze: Satin Nickel
  - Chrome: Polished Nickel
- Credenzas include one adjustable shelf behind each door unless other components are specified
- Equipment racks hold 12RU and include a thermostatically controlled fan and plug strip



# SOLID SURFACE TOP

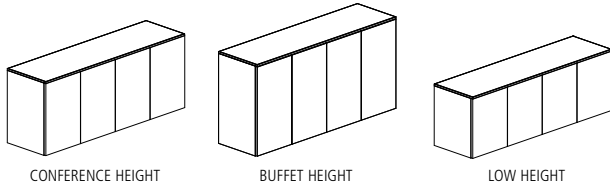

**CASE MATERIAL KEY**

PA Painted Case  
V Veneer Case

**CASE ONLY**

MODEL #	W x D x H	DESCRIPTION	-PA	-V
<b>CONFERENCE HEIGHT (29 INCH CASE)</b>				
FWCC-3629-SS	36 x 20 x 29	Two Doors	6,509	7,230
FWCC-5429-SS	54 x 20 x 29	Three Doors	8,472	9,415
FWCC-7229-SS	72 x 20 x 29	Four Doors	10,437	11,598
FWCC-9029-SS	90 x 20 x 29	Five Doors	12,405	13,779
FWCD-3629-SS	36 x 24 x 29	Two Doors	7,160	7,952
FWCD-5429-SS	54 x 24 x 29	Three Doors	9,320	10,355
FWCD-7229-SS	72 x 24 x 29	Four Doors	11,481	12,756
FWCD-9029-SS	90 x 24 x 29	Five Doors	13,642	15,158
<b>BUFFET HEIGHT (36 INCH CASE)</b>				
FWBC-3636-SS	36 x 20 x 36	Two Doors	7,481	8,316
FWBC-5436-SS	54 x 20 x 36	Three Doors	9,740	10,822
FWBC-7236-SS	72 x 20 x 36	Four Doors	12,001	13,331
FWBC-9036-SS	90 x 20 x 36	Five Doors	14,261	15,846
FWBD-3636-SS	36 x 24 x 36	Two Doors	8,233	9,145
FWBD-5436-SS	54 x 24 x 36	Three Doors	10,715	11,902
FWBD-7236-SS	72 x 24 x 36	Four Doors	13,201	14,669
FWBD-9036-SS	90 x 24 x 36	Five Doors	15,687	17,429
<b>LOW HEIGHT (24 INCH CASE)</b>				
FWLC-3624-SS	36 x 20 x 24	Two Doors	6,029	6,695
FWLC-5424-SS	54 x 20 x 24	Three Doors	7,845	8,721
FWLC-7224-SS	72 x 20 x 24	Four Doors	9,665	10,740
FWLC-9024-SS	90 x 20 x 24	Five Doors	11,485	12,760
FWLD-3624-SS	36 x 24 x 24	Two Doors	6,627	7,364
FWLD-5424-SS	54 x 24 x 24	Three Doors	8,630	9,588
FWLD-7224-SS	72 x 24 x 24	Four Doors	10,632	11,813
FWLD-9024-SS	90 x 24 x 24	Five Doors	12,633	14,037

**DOOR STYLE**

DESCRIPTION	CODE	NOTES	PRICE
Plank Veneer	-PWD	Available in Clear Coat Walnut	\$301
Vertical Veneer	-VD		No Charge
Horizontal Veneer	-HD		No Charge
Veneer/Paint Combination	-VPD	Reference page 8 for predetermined accent door locations	No Charge
Painted	-PAD		No Charge



# SOLID SURFACE TOP

OPTIONS	CODE	PRICE	NOTES
Locks	Add <b>-LK</b>	\$301	
Drawers Behind Doors (Buffet Height - 36" Case Only)	Add <b>-D</b>	\$587	
<b>Equipment Rack Options - Conference Height and Buffet Height Credenzas:</b>			
Fixed Equipment Rack	Add <b>-R2</b>	\$906	Available for 24" deep Credenzas, behind the left most pair of doors
Sliding Equipment Rack	Add <b>-R1</b>	\$3,317	Available for 24" deep Credenzas, behind the left most pair of doors
<b>Waste/Recycling Unit Options:</b>			
Single Pull-Out Waste/Recycling Unit	Add <b>-TF1</b>	\$295	Available for 20" deep Credenzas only (Wall-Hung excluded), behind right most doors
Double Pull-Out Waste/Recycling Unit	Add <b>-TF2</b>	\$456	Available for 24" depth credenzas only (Wall-Hung excluded), behind right most doors

**REQUIRED INFORMATION (ORDER CANNOT BE ENTERED WITHOUT THIS INFORMATION):**

See pages vi-vii for surface material options.

- Choose Door Style: Defaults to case finish, if none selected
- Choose Solid Surface Finish
- Choose Paint Finish, if specified
- Choose Wood Species & Finish, if specified

**GENERAL INFORMATION**

- Solid Surface tops are 1/2" thick
- Plank veneer is hand selected walnut veneers of varying character and color, with a clear coat finish, to accentuate the plank appearance
- When Plank veneer door style is specified with a veneer case, case and top will default to clear coat walnut in standard slip-match layup
- When veneer case is specified, the case exterior is standard slip-match layup regardless of veneer door style selection
- Pull-Out Waste/Recycling Bin size: 14" x 10-1/2" x 18"; (1) 36 Qt.; Double Pull-Out Waste/Recycling Units include two bins
- Locks
  - Veneer (Case Only) - When lock option is specified, color will default to Satin Nickel
  - Painted (Case Only) - When lock option is specified, color will default based on Paint finish:
    - Aged Bronze, Black, Galaxy, Shadow, and Storm: Black
    - Cloud: White
    - Burnish, Foil, Satin Bronze: Satin Nickel
    - Chrome: Polished Nickel
- Credenzas include one adjustable shelf behind each door unless other components are specified
- Equipment racks hold 12RU and include a thermostatically controlled fan and plug strip



# SOLID SURFACE TOP

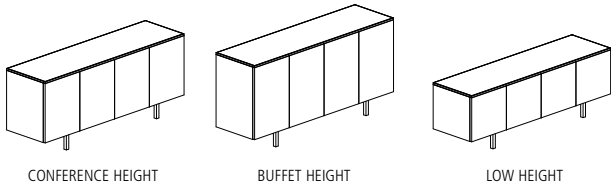

**CASE MATERIAL KEY**

PA-IB Painted Case with Inset Leg  
 V-IB Veneer Case with Inset Leg

**INSET LEG**

MODEL #	W x D x H	DESCRIPTION	-PA-IB	-V-IB
<b>CONFERENCE HEIGHT (23.5 IN. CASE WITH 6.5 IN. INSET LEG)</b>				
FWLC-3629-SS	36 x 20 x 30	Two Doors	6,474	7,142
FWLC-5429-SS	54 x 20 x 30	Three Doors	8,288	9,162
FWLC-7229-SS	72 x 20 x 30	Four Doors	10,108	11,180
FWLC-9029-SS	90 x 20 x 30	Five Doors	11,927	13,204
FWLD-3629-SS	36 x 24 x 30	Two Doors	7,072	7,809
FWLD-5429-SS	54 x 24 x 30	Three Doors	9,073	10,035
FWLD-7229-SS	72 x 24 x 30	Four Doors	11,075	12,258
FWLD-9029-SS	90 x 24 x 30	Five Doors	13,078	14,484
<b>BUFFET HEIGHT (28.5 IN. CASE WITH 6.5 IN. INSET LEG)</b>				
FWCC-3636-SS	36 x 20 x 35	Two Doors	6,952	7,675
FWCC-5436-SS	54 x 20 x 35	Three Doors	8,918	9,860
FWCC-7236-SS	72 x 20 x 35	Four Doors	10,883	12,041
FWCC-9036-SS	90 x 20 x 35	Five Doors	12,848	14,225
FWCD-3636-SS	36 x 24 x 35	Two Doors	7,603	8,396
FWCD-5436-SS	54 x 24 x 35	Three Doors	9,764	10,801
FWCD-7236-SS	72 x 24 x 35	Four Doors	11,925	13,201
FWCD-9036-SS	90 x 24 x 35	Five Doors	14,088	15,604
<b>LOW HEIGHT (17.5 IN. CASE WITH 6.5 IN. INSET LEG)</b>				
FWWC-3624-SS	36 x 20 x 24	Two Doors	6,146	6,592
FWWC-5424-SS	54 x 20 x 24	Three Doors	7,865	8,450
FWWC-7224-SS	72 x 20 x 24	Four Doors	9,582	10,303
FWWC-9024-SS	90 x 20 x 24	Five Doors	11,303	12,158

**DOOR STYLE**

DESCRIPTION	CODE	NOTES	PRICE
Plank Veneer	-PWD	Available in Clear Coat Walnut	\$301
Vertical Veneer	-VD		No Charge
Horizontal Veneer	-HD		No Charge
Veneer/Paint Combination	-VPD	Reference page 8 for predetermined accent door locations	No Charge
Painted	-PAD		No Charge

**OPTIONS**

	CODE	PRICE	NOTES
Locks	Add <b>-LK</b>	\$301	
Polished Chrome Base	Add <b>-PCIB</b>	\$479	
<b>Equipment Rack Options - Buffet Height Credenzas:</b>			
Fixed Equipment Rack	Add <b>-R2</b>	\$906	Available for 24" deep Credenzas, behind the left most pair of doors
Sliding Equipment Rack	Add <b>-R1</b>	\$3,317	Available for 24" deep Credenzas, behind the left most pair of doors
<b>Waste/Recycling Unit Options:</b>			
Single Pull-Out Waste/Recycling Unit	Add <b>-TF1</b>	\$295	Available for 20" deep Credenzas only (Wall-Hung excluded), behind right most doors
Double Pull-Out Waste/Recycling Unit	Add <b>-TF2</b>	\$456	Available for 24" depth credenzas only (Wall-Hung excluded), behind right most doors



# SOLID SURFACE TOP

**REQUIRED INFORMATION (ORDER CANNOT BE ENTERED WITHOUT THIS INFORMATION):**

See pages vi-vii for surface material options.

- Choose Door Style: Defaults to case finish, if none selected
- Choose Metal Finish
- Choose Solid Surface Finish
- Choose Paint Finish, if specified
- Choose Wood Species & Finish, if specified

**GENERAL INFORMATION**

- Solid Surface tops are 1/2" thick
- Plank veneer is hand selected walnut veneers of varying character and color, with a clear coat finish, to accentuate the plank appearance
- When Plank veneer door style is specified with a veneer case, case and top will default to clear coat walnut in standard slip-match layup
- When veneer case is specified, the case exterior is standard slip-match layup regardless of veneer door style selection
- Pull-Out Waste/Recycling Bin size: 14" x 10-1/2" x 18"; (1) 36 Qt.; Double Pull-Out Waste/Recycling Units include two bins
- When lock option is specified, color will default based on leg finish:
  - Aged Bronze, Black, Galaxy, Shadow, and Storm: Black
  - Cloud: White
  - Burnish, Foil, and Satin Bronze: Satin Nickel
  - Chrome: Polished Nickel
- Credenzas include one adjustable shelf behind each door unless other components are specified
- Equipment racks hold 12RU and include a thermostatically controlled fan and plug strip



# SOLID SURFACE TOP

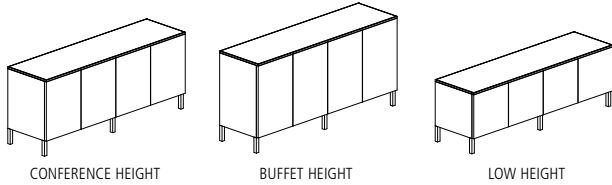

**CASE MATERIAL KEY**

PA-OB Painted Case with Edge-mount Post Leg  
 V-OB Veneer Case with Edge-mount Post Leg

**EDGE-MOUNT POST LEG**

MODEL #	W x D x H	DESCRIPTION	-PA-OB	-V-OB
<b>CONFERENCE HEIGHT (23.5 IN. CASE WITH 6.5 IN. EDGE-MOUNT POST LEG)</b>				
FWLC-3629-SS	36 x 20 x 30	Two Door	6,474	7,142
FWLC-5429-SS	54 x 20 x 30	Three Door	8,288	9,162
FWLC-7229-SS	72 x 20 x 30	Four Door	10,108	11,180
FWLC-9029-SS	90 x 20 x 30	Five Door	11,927	13,204
FWLD-3629-SS	36 x 24 x 30	Two Door	7,072	7,809
FWLD-5429-SS	54 x 24 x 30	Three Door	9,073	10,035
FWLD-7229-SS	72 x 24 x 30	Four Door	11,075	12,258
FWLD-9029-SS	90 x 24 x 30	Five Door	13,078	14,484
<b>BUFFET HEIGHT (28.5 IN. CASE WITH 6.5 IN. EDGE-MOUNT POST LEG)</b>				
FWCC-3636-SS	36 x 20 x 35	Two Door	6,952	7,675
FWCC-5436-SS	54 x 20 x 35	Three Door	8,918	9,860
FWCC-7236-SS	72 x 20 x 35	Four Door	10,883	12,041
FWCC-9036-SS	90 x 20 x 35	Five Door	12,848	14,225
FWCD-3636-SS	36 x 24 x 35	Two Door	7,603	8,396
FWCD-5436-SS	54 x 24 x 35	Three Door	9,764	10,801
FWCD-7236-SS	72 x 24 x 35	Four Door	11,925	13,201
FWCD-9036-SS	90 x 24 x 35	Five Door	14,088	15,604
<b>LOW HEIGHT (17.5 IN. CASE WITH 6.5 IN. EDGE-MOUNT POST LEG)</b>				
FWWC-3624-SS	36 x 20 x 24	Two Door	6,146	6,592
FWWC-5424-SS	54 x 20 x 24	Three Door	7,865	8,450
FWWC-7224-SS	72 x 20 x 24	Four Door	9,582	10,303
FWWC-9024-SS	90 x 20 x 24	Five Door	11,303	12,158

**DOOR STYLE**

DESCRIPTION	CODE	NOTES	PRICE
Plank Veneer	-PWD	Available in Clear Coat Walnut	\$301
Vertical Veneer	-VD		No Charge
Horizontal Veneer	-HD		No Charge
Veneer/Paint Combination	-VPD	Reference page 8 for predetermined accent door locations	No Charge
Painted	-PAD		No Charge

OPTIONS	CODE	PRICE	NOTES
Locks	Add <b>-LK</b>	\$301	
Polished Chrome Base	Add <b>-PCOB</b>	\$517	
<b>Equipment Rack Options - Buffet Height Credenzas:</b>			
Fixed Equipment Rack	Add <b>-R2</b>	\$906	Available for 24" deep Credenzas, behind the left most pair of doors
Sliding Equipment Rack	Add <b>-R1</b>	\$3,317	Available for 24" deep Credenzas, behind the left most pair of doors
<b>Waste/Recycling Unit Options:</b>			
Single Pull-Out Waste/Recycling Unit	Add <b>-TF1</b>	\$295	Available for 20" deep Credenzas only (Wall-Hung excluded), behind right most doors
Double Pull-Out Waste/Recycling Unit	Add <b>-TF2</b>	\$456	Available for 24" depth credenzas only (Wall-Hung excluded), behind right most doors



# SOLID SURFACE TOP

**REQUIRED INFORMATION (ORDER CANNOT BE ENTERED WITHOUT THIS INFORMATION):**

See pages vi-vii for surface material options.

- Choose Door Style: Defaults to case finish, if none selected
- Choose Metal Finish
- Choose Solid Surface Finish
- Choose Paint Finish, if specified
- Choose Wood Species & Finish, if specified

**GENERAL INFORMATION**

- Solid Surface tops are 1/2" thick
- Plank veneer is hand selected walnut veneers of varying character and color, with a clear coat finish, to accentuate the plank appearance
- When Plank veneer door style is specified with a veneer case, case and top will default to clear coat walnut in standard slip-match layup
- When veneer case is specified, the case exterior is standard slip-match layup regardless of veneer door style selection
- Pull-Out Waste/Recycling Bin size: 14" x 10-1/2" x 18"; (1) 36 Qt.; Double Pull-Out Waste/Recycling Units include two bins
- When lock option is specified, color will default based on leg finish:
  - Aged Bronze, Black, Galaxy, Shadow, and Storm: Black
  - Cloud: White
  - Burnish, Foil, and Satin Bronze: Satin Nickel
  - Chrome: Polished Nickel
- Credenzas include one adjustable shelf behind each door unless other components are specified
- Equipment racks hold 12RU and include a thermostatically controlled fan and plug strip



# SOLID SURFACE TOP

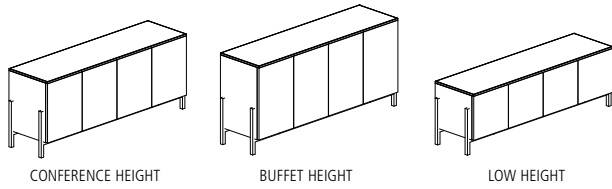

### CASE MATERIAL KEY

PA-CB Painted Case with Cradle Base  
 V-CB Veneer Case with Cradle Base

### CRADLE BASE

MODEL #	W x D x H	DESCRIPTION	-PA-CB	-V-CB
<b>CONFERENCE HEIGHT (23.5 IN. CASE WITH 6.5 IN. CRADLE BASE)</b>				
FWLC-3629-SS	36 x 20 x 30	Two Doors	7,065	7,736
FWLC-5429-SS	54 x 20 x 30	Three Doors	8,882	9,755
FWLC-7229-SS	72 x 20 x 30	Four Doors	10,701	11,775
FWLC-9029-SS	90 x 20 x 30	Five Doors	12,522	13,799
FWLD-3629-SS	36 x 24 x 30	Two Doors	7,669	8,403
FWLD-5429-SS	54 x 24 x 30	Three Doors	9,668	10,629
FWLD-7229-SS	72 x 24 x 30	Four Doors	11,670	12,849
FWLD-9029-SS	90 x 24 x 30	Five Doors	13,673	15,076
<b>BUFFET HEIGHT (28.5 IN. CASE WITH 6.5 IN. CRADLE BASE)</b>				
FWCC-3636-SS	36 x 20 x 35	Two Doors	7,548	8,268
FWCC-5436-SS	54 x 20 x 35	Three Doors	9,513	10,452
FWCC-7236-SS	72 x 20 x 35	Four Doors	11,476	12,634
FWCC-9036-SS	90 x 20 x 35	Five Doors	13,442	14,817
FWCD-3636-SS	36 x 24 x 35	Two Doors	8,200	8,990
FWCD-5436-SS	54 x 24 x 35	Three Doors	10,357	11,394
FWCD-7236-SS	72 x 24 x 35	Four Doors	12,520	13,794
FWCD-9036-SS	90 x 24 x 35	Five Doors	14,682	16,196
<b>LOW HEIGHT (17.5 IN. CASE WITH 6.5 IN. CRADLE BASE)</b>				
FWWC-3624-SS	36 x 20 x 24	Two Doors	6,741	7,185
FWWC-5424-SS	54 x 20 x 24	Three Doors	8,461	9,043
FWWC-7224-SS	72 x 20 x 24	Four Doors	10,178	10,898
FWWC-9024-SS	90 x 20 x 24	Five Doors	11,897	12,754

### DOOR STYLE

DESCRIPTION	CODE	NOTES	PRICE
Plank Veneer	-PWD	Available in Clear Coat Walnut	\$301
Vertical Veneer	-VD		No Charge
Horizontal Veneer	-HD		No Charge
Veneer/Paint Combination	-VPD	Reference page 8 for predetermined accent door locations	No Charge
Painted	-PAD		No Charge

### OPTIONS

	CODE	PRICE	NOTES
Locks	Add <b>-LK</b>	\$301	
Polished Chrome Base	Add <b>-PCCB</b>	\$1,698	
<b>Equipment Rack Options - Buffet Height Credenzas:</b>			
Fixed Equipment Rack	Add <b>-R2</b>	\$906	Available for 24" deep Credenzas, behind the left most pair of doors
Sliding Equipment Rack	Add <b>-R1</b>	\$3,317	Available for 24" deep Credenzas, behind the left most pair of doors
<b>Waste/Recycling Unit Options:</b>			
Single Pull-Out Waste/Recycling Unit	Add <b>-TF1</b>	\$295	Available for 20" deep Credenzas only (Wall-Hung excluded), behind right most doors
Double Pull-Out Waste/Recycling Unit	Add <b>-TF2</b>	\$456	Available for 24" depth credenzas only (Wall-Hung excluded), behind right most doors





# SOLID SURFACE TOP

**REQUIRED INFORMATION (ORDER CANNOT BE ENTERED WITHOUT THIS INFORMATION):**

See pages vi-vii for surface material options.

- Choose Door Style: Defaults to case finish, if none selected
- Choose Metal Finish
- Choose Solid Surface Finish
- Choose Paint Finish, if specified
- Choose Wood Species & Finish, if specified

**GENERAL INFORMATION**

- Solid Surface tops are 1/2" thick
- Plank veneer is hand selected walnut veneers of varying character and color, with a clear coat finish, to accentuate the plank appearance
- When Plank veneer door style is specified with a veneer case, case and top will default to clear coat walnut in standard slip-match layup
- When veneer case is specified, the case exterior is standard slip-match layup regardless of veneer door style selection
- Pull-Out Waste/Recycling Bin size: 14" x 10-1/2" x 18"; (1) 36 Qt.; Double Pull-Out Waste/Recycling Units include two bins
- When lock option is specified, color will default based on leg finish:
  - Aged Bronze, Black, Galaxy, Shadow, and Storm: Black
  - Cloud: White
  - Burnish, Foil, and Satin Bronze: Satin Nickel
  - Chrome: Polished Nickel
- Credenzas include one adjustable shelf behind each door unless other components are specified
- Equipment racks hold 12RU and include a thermostatically controlled fan and plug strip



# SOLID SURFACE TOP

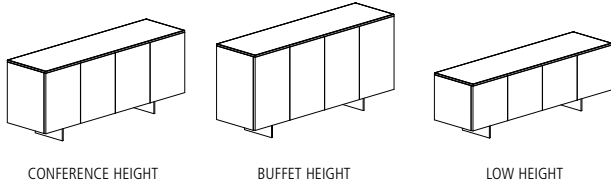

**CASE MATERIAL KEY**

PA-BB Painted Case with Blade Base  
 V-BB Veneer Case with Blade Base

**BLADE BASE**

MODEL #	W x D x H	DESCRIPTION	-PA-BB	-V-BB
<b>CONFERENCE HEIGHT (23.5 IN. CASE WITH 6.5 IN. BLADE LEG)</b>				
FWLC-3629-SS	36 x 20 x 30	Two Doors	6,769	7,438
FWLC-5429-SS	54 x 20 x 30	Three Doors	8,586	9,456
FWLC-7229-SS	72 x 20 x 30	Four Doors	10,405	11,478
FWLC-9029-SS	90 x 20 x 30	Five Doors	12,226	13,501
FWLD-3629-SS	36 x 24 x 30	Two Doors	7,371	8,105
FWLD-5429-SS	54 x 24 x 30	Three Doors	9,371	10,332
FWLD-7229-SS	72 x 24 x 30	Four Doors	11,370	12,553
FWLD-9029-SS	90 x 24 x 30	Five Doors	13,375	14,779
<b>BUFFET HEIGHT (28.5 IN. CASE WITH 6.5 IN. BLADE LEG)</b>				
FWCC-3636-SS	36 x 20 x 35	Two Doors	7,250	7,970
FWCC-5436-SS	54 x 20 x 35	Three Doors	9,215	10,156
FWCC-7236-SS	72 x 20 x 35	Four Doors	11,179	12,339
FWCC-9036-SS	90 x 20 x 35	Five Doors	13,145	14,522
FWCD-3636-SS	36 x 24 x 35	Two Doors	7,902	8,692
FWCD-5436-SS	54 x 24 x 35	Three Doors	10,064	11,097
FWCD-7236-SS	72 x 24 x 35	Four Doors	12,224	13,496
FWCD-9036-SS	90 x 24 x 35	Five Doors	14,386	15,899
<b>LOW HEIGHT (17.5 IN. CASE WITH 6.5 IN. BLADE LEG)</b>				
FWWC-3624-SS	36 x 20 x 24	Two Doors	6,443	6,888
FWWC-5424-SS	54 x 20 x 24	Three Doors	8,163	8,749
FWWC-7224-SS	72 x 20 x 24	Four Doors	9,879	10,600
FWWC-9024-SS	90 x 20 x 24	Five Doors	11,601	12,454

**DOOR STYLE**

DESCRIPTION	CODE	NOTES	PRICE
Plank Veneer	-PWD	Available in Clear Coat Walnut	\$301
Vertical Veneer	-VD		No Charge
Horizontal Veneer	-HD		No Charge
Veneer/Paint Combination	-VPD	Reference page 8 for predetermined accent door locations	No Charge
Painted	-PAD		No Charge

**OPTIONS**

OPTIONS	CODE	PRICE	NOTES
Locks	Add <b>-LK</b>	\$301	
Polished Chrome Base	Add <b>-PCBB</b>	\$479	
<b>Equipment Rack Options - Buffet Height Credenzas:</b>			
Fixed Equipment Rack	Add <b>-R2</b>	\$906	Available for 24" deep Credenzas, behind the left most pair of doors
Sliding Equipment Rack	Add <b>-R1</b>	\$3,317	Available for 24" deep Credenzas, behind the left most pair of doors
<b>Waste/Recycling Unit Options:</b>			
Single Pull-Out Waste/Recycling Unit	Add <b>-TF1</b>	\$295	Available for 20" deep Credenzas only (Wall-Hung excluded), behind right most doors
Double Pull-Out Waste/Recycling Unit	Add <b>-TF2</b>	\$456	Available for 24" depth credenzas only (Wall-Hung excluded), behind right most doors



# SOLID SURFACE TOP

**REQUIRED INFORMATION (ORDER CANNOT BE ENTERED WITHOUT THIS INFORMATION):**

See pages vi-vii for surface material options.

- Choose Door Style: Defaults to case finish, if none selected
- Choose Metal Finish
- Choose Solid Surface Finish
- Choose Paint Finish, if specified
- Choose Wood Species & Finish, if specified

**GENERAL INFORMATION**

- Solid Surface tops are 1/2" thick
- Plank veneer is hand selected walnut veneers of varying character and color, with a clear coat finish, to accentuate the plank appearance
- When Plank veneer door style is specified with a veneer case, case and top will default to clear coat walnut in standard slip-match layup
- When veneer case is specified, the case exterior is standard slip-match layup regardless of veneer door style selection
- Pull-Out Waste/Recycling Bin size: 14" x 10-1/2" x 18"; (1) 36 Qt.; Double Pull-Out Waste/Recycling Units include two bins
- When lock option is specified, color will default based on leg finish:
  - Aged Bronze, Black, Galaxy, Shadow, and Storm: Black
  - Cloud: White
  - Burnish, Foil, and Satin Bronze: Satin Nickel
  - Chrome: Polished Nickel
- Credenzas include one adjustable shelf behind each door unless other components are specified
- Equipment racks hold 12RU and include a thermostatically controlled fan and plug strip



# Appendix

---



# GENERAL INFORMATION

This price book supercedes all previous versions.

**Before placing your order, confirm you have all required information necessary. Lead times for orders begin after all required information is included and correct.**

## Delivery Information

We know lead times are important and sticking to them even more so. We work to maintain a 6-8 week lead time on all standard products in this book from receipt of a clean order. All orders are acknowledged with an approximate shipping date and will be invoiced with the price in effect at the date the purchase order is received. For current lead times, please review [www.nucraft.com/resources/lead-times](http://www.nucraft.com/resources/lead-times).

Shipping charges are prepaid (within the continental U.S.). Therefore, pricing is a delivered price based on normal ground transportation. If you have special instructions, need to ship by air, or are shipping to Alaska or Hawaii, contact Nucraft Customer Service. Nucraft can also help arrange to have products blanket wrapped for an additional charge. Contact the Nucraft Customer Service team or specify it on your purchase order.

**Minimum Freight Charge: Any order below \$2,900 net will be assessed a \$475 net minimum freight charge (one per order).**

Orders are subject to acquiring the materials required for manufacturing. Fulfillment can be affected by strikes, fires, embargoes and acts of government. These elements are beyond our control.

Nucraft offers a variety of services to accommodate a wide range of delivery requirements. Availability of these services is dependent on a number of factors and may not be offered with all shipments. Examples of delivery services that have additional fees include:

- Specific date
- Specific time of day, morning or afternoon
- Delivery to a warehouse before delivery to its final destination (unless product is picked up at the warehouse)

Contact the Nucraft Customer Service team for availability and pricing on these services.

## Freight Terms

Shipping charges for Nucraft products are prepaid for standard delivery in the continental United States. Standard delivery is defined as follows: Product is delivered on a 53' trailer being pulled by a long-haul tractor (total length of 85'). Facility will receive delivery Monday through Friday between the hours of 8:00 AM and 4:00 PM. Facility has docks with levelers and a fork truck for unloading. Product will be loaded on load bars two levels high. Receiving facility is responsible to have personnel on hand to unload the truck upon arrival, drivers do not unload. Delivery sites or times that do not meet these criteria may be accommodated, but will incur a charge to cover additional shipping costs. Please **notify Nucraft a minimum of two weeks prior to shipment** to arrange special services and determine additional charges.

## Storage

Nucraft has no storage facilities for finished product. If a customer cannot accept an order when it is ready for shipment, the customer must designate an alternative shipping address. If no address is provided, Nucraft may, at its discretion, transfer the product to storage. If product is transferred to an off-site storage facility, the customer may be charged for transportation to the facility and for any associated storage fees. Nucraft considers transfer of the product to a storage facility the equivalent of shipment, including invoicing and payment. Customers assume the risk of damage or loss during storage.

## Transportation Times and Delays

Third party carriers that Nucraft contracts with will make reasonable efforts to accommodate requested delivery times and dates. Scheduled delivery appointments may, however, be delayed for a variety of reasons, including inclement weather, traffic, transportation equipment problems, and delays encountered at other delivery locations along the delivery route. Nucraft does not recommend scheduling activities that depend on the delivery appointment (for example, scheduling furniture installers to install furniture the day of the delivery appointment). Nucraft shall not be liable for any costs incurred as a result of a missed delivery appointment.

## Shipment Damage Claims

Legal title to merchandise passes to the buyer upon acceptance by the carrier. Inspect all cartons upon delivery. Details of visible damage should be noted on the delivery receipt. Do not destroy packaging, transport to site, or install product if damage is found upon inspection. Inspection of products should be completed upon delivery to the receiver. If visible damage is apparent, a claim should be filed immediately with Nucraft Customer Service. If visible damage is not apparent, sign the delivery receipt "No visible damage." This will allow recourse for a concealed damage claim. Concealed damage claims must be filed within 15 days of receipt, **prior to transporting or installing any product.**

Do not destroy packing materials until shipment has been inspected. If damage is found, proceed to file a claim with Nucraft Customer Service.

**Failure to make any claims against Nucraft within 15 days shall constitute acceptance of the merchandise and a waiver of any defects, errors or shortages discovered upon inspection.**

## Cancellations

Cancellations must be reviewed by our Customer Service team. Because we build your products to order, orders cannot be cancelled once processing has begun. Processing includes but is not limited to development of shop drawings and other engineering drawings. If cancellation is approved, a processing fee of 20-100% will be assessed based on the status of the order.

## Change Order Policy

Nucraft will make every attempt to honor any reasonable change request to product provided that the request is received prior to start of production. Change orders will be accepted only if the request is made in writing and received in time to make the change. Nucraft reserves the right to increase our acknowledged price and ship date if necessary to make the requested changes. Please submit any change order request to our Customer Service team. Nucraft will assess charges to the customer as stipulated in the following:

- Standard Orders: Change orders received prior to production will be charged \$400 net to cover administrative costs.
- Special Orders: Change orders received prior to production will be charged \$400 net to cover administrative costs. There may be additional costs associated with engineering labor required for the change order.
- Change orders received after production must be evaluated by Nucraft. If approved, the charge will be \$400 net plus any restocking charges accumulated. There may be additional costs associated with engineering and/or manufacturing labor, as well as material costs, required for the change order.



# GENERAL INFORMATION

## Repair Authorization

Prior written approval is required for repairs of merchandise charged to Nucraft. Failure to do so will result in customer funded repairs.

## Payment Terms

Deposits are required at the time of order due to the custom nature of our products. See information regarding Cancellations above.

Credit terms are available to qualified customers. Please contact AR@Nucraft.com to start the application process. Note that the credit application process requires a valid sales tax exemption or resale tax certificate, Form W-9, and three current trade references.

Credit Card Payments are accepted via web portal. Please contact AR@Nucraft.com for payment instructions. Note that a 2% convenience fee will be added for using this payment method and no early pay discounts are allowed on credit card payments.

## Warranty

Nucraft Furniture is warranted to be free from defects in materials and workmanship for a period of ten years of single shift use. Limitations include:

- Mechanical Devices such as latches, casters, and other moving components are warranted for five years of the date of original delivery.
- Height adjustable components are warranted for two years of the date of original delivery.
- The following are warranted for one year of the date of original delivery:
  - Textiles
  - Electrical Components
  - Refrigeration Units
  - Custom Products not described in Nucraft's Catalogue

This warranty is applicable only if furniture is properly installed and maintained in an office environment. This warranty extends only to products manufactured and sold in North America and only to original purchasers acquiring new Nucraft product through authorized dealers or approved sellers.

During this warranty period, Nucraft's sole obligation is to repair or replace, at Nucraft's discretion, products which prove to be defective during the warranty period.

This warranty does not cover:

- Damage caused by a carrier.
- Damage from user modification, misuse, abuse, accident, or negligence.
- Customer's Own Material (COM) specified by the customer that is not a standard product offering.
- Color, grain, or texture of wood and other covering material.

**Nucraft extends no other warranties, expressed or implied, including warranty of merchantability or fitness for a particular purpose. Nucraft shall not be liable for loss of time, inconvenience, commercial loss, incidental or consequential damages.**

## Environmental Statement

Nucraft is committed to supporting responsible environmental policies and practices in all that we do. We strive for sustainability, weighing our business decisions against the costs to the ecological, social and economic systems they affect.

Our products are manufactured to meet the credit requirements of the U.S. Green Building Council's LEED rating systems in one or more of the following categories:

- Recycled Content
- Certified Wood
- Low-Emitting Materials

## Computer Aided Planning

Nucraft products and pricing are available via CET and 2020 Cap, an AutoCAD®-based space planning tool.

2020 Cap is an integrated software system developed specifically for interior designers and facility planners to enhance workplace performance. This modern suite of applications works together seamlessly, in concert. Navigate catalogs, select products, design in plan view and 3D, assign options, create worksheets and build a project where you want, when you want. Take your pick. It's dynamic and interactive. Design projects are a work in progress. And now you can perform any of the many discrete tasks that go into a project any time, any place.

For additional information, you may contact 2020 Cap direct at 800-227-0038.

Product symbols (Revit, 2D and 3D) are available on the Nucraft website at [www.nucraft.com/resources/product-symbols](http://www.nucraft.com/resources/product-symbols).

## iSpec®

Nucraft offers a free online product configuration and specification service that saves you time and allows you to be creative while leaving the nuts and bolts to someone else. No specific software is required, nor is there any learning curve. This service applies to all Nucraft products. For additional information, call 1-877-NUCRAFT and ask for the iSpec Team or log on to [www.nucraft.com/resources/ispec](http://www.nucraft.com/resources/ispec).



# FINISH INFORMATION

## Surface Materials Palette

We crafted our materials palette using the same demanding standards that distinguish our furniture. Thoughtful design and attention to every detail elevate your possibilities.

Anchored by Nucraft veneers, unrivaled for clarity, quality, and depth of finish, our collection of surface materials comprises a sophisticated set of balanced elements that supports your design vision.

Some elements have their roots in Nucraft's rich heritage. Others are new materials and reflect current trends and taste. Together, they ensure that you're ready for today and positioned well for the future. Beautifully.

## Custom Finishes

Nucraft specializes in expert custom finish matching. For a nominal upcharge we can provide custom finishes, and we are frequently asked to match the finishes of other furniture manufacturers. For finishes that appear unusual to match or for customers directly requesting a sample, a finish sample will be sent for approval prior to entering the order.

Custom finishes requiring colored varnishes to create a painted look can only be applied to Maple veneer and require one extra week in addition to the standard lead time. Nucraft's standard black finish (G82) can be applied to all Nucraft standard veneers. Walnut is the standard black veneer. Other species must be specified when ordering.

Clear coat on a special veneer requires an approved sample.

Custom finishes carry a 10% upcharge per item, per finish, capped at \$2,100 List.

Custom finish upcharges are not applied to any item that is not wood. Example: casters, ganging connectors, power options..

## Treatments

**Note: Default veneer sheen will vary per finish and product. Default finish is bolded on pages vi-vii. If no direction is provided on incoming orders, default sheen will be selected. In addition, default veneer cut is noted in the price list. If no direction is provided on incoming orders, default cut will be selected.**

**Gloss:** Gloss is a durable finish that tends to nicely mask normal wear and leaves wood grain visible to the eye. It achieves a medium gloss open pore appearance (40 – 50 sheen range). Finish numbers preceded by the letter "G" indicate a Gloss finish.

**Matte:** Like Gloss, Matte is durable, tends to nicely mask normal wear and leaves wood grain visible to the eye. It achieves a low luster, open pore appearance (10 – 20 sheen range). Finish numbers preceded by the letter "M" indicate a Matte finish.

Since each veneer type responds differently to both types of treatment, all will have a distinctive look and feel when finished. For example, a Walnut veneer with a Gloss treatment will remain much more textured than a Cherry veneer with the same treatment.

## About the Wood

All Nucraft veneers are carefully selected for uniformity of color and grain. Still, wood is a natural substance and minor variations may occur due to its own uniqueness. Because of this, the furniture you receive may not be an exact match to our samples.

Nucraft takes great pride in our finish color consistency. However, wood is a natural product that will have color variation within a single piece of furniture, as well as from one piece to the next. Other factors also affect color over time, such as exposure to light (both intensity and duration). For example, lighter finishes cause more variation in colors over time.

In cases where a returning customer wants a precise match with existing furniture, we recommend sending a sample of the existing furniture finish. Please contact Nucraft Customer Service to determine an appropriate sample. This will ensure a finish match between old and new orders. This type of order is considered a control sample. There will be a 10% upcharge on an order of this type. Due to natural aging of veneers, natural finishes may vary.

## Care and Maintenance of Wood Finishes

Our finish material is a crystal clear, urethane acrylic blend. This type of finish may be repaired in the field by a qualified refinisher.

Nucraft recommends using a damp cloth to clean your fine wood furniture. Always wipe with the grain of the wood. Should your wood furniture require a more thorough cleaning, we recommend using a mild cleaner such as Joy dish soap or Murphy's oil soap, thoroughly diluted in water (one part soap to thirty parts water). Water will not damage Nucraft's finish, but it may leave surface spots when it dries. To avoid this, dry the surface with a soft cloth after it is cleaned. Marks that cannot be removed with the cleaning methods above may be able to be removed using naphtha, a mild degreasing solvent.

Caution: while the use of polishes that contain wax, petroleum solvents or silicones may immediately enhance the "shine" of a product, it may also eventually remove the fine original finish applied in our factory. Silicone on the surface of wood may also make it very difficult to respray or refinish.

All Nucraft furniture is inspected and polished before it leaves our factory. In some instances, the packing materials may imprint on the factory polish. Cleaning and polishing the furniture once it is unpacked will normally restore the furniture to its original beauty.

In some cases, the rubber support feet used on the bottom of common office equipment (teleconferencing phones, laptops, microphones, copiers, etc.) can create unsightly marks in the surface of wood tops, due to oxidation of the lacquer finish. We suggest these machines be placed on a protective type of padding, such as felt.

Wood will fade as a result of exposure to UV light. This is particularly prevalent with light finishes. If color changes due to fading are a concern for your application, the impact can be minimized by selecting medium to dark stains for your wood surfaces. Our top coat includes a UV inhibitor which makes the finishes less prone to fading.



# FINISH INFORMATION

## Laminates

Selected Formica®, Nevamar®, and Wilsonart® laminates are available on Training Tables, Conference Tables, Conference Room Furniture and select Occasional Tables. For standard laminate and wood pricing, refer to individual item pricing columns.

## Non-Standard Laminates and Linoleums

To order a color other than those on our list (see pages vi-vii), refer to Nevamar or Formica standard grade, matte texture laminate offerings and Forbo Furniture Linoleums (excluding manufacturers' non-standard matte offering).

Nucraft can support other laminate and linoleum options beyond what can be found as standard options on pages vi-viii. For pricing, please send a request to quotes@nucraft.com.

## Care and Maintenance of Laminate and Novawrap

Laminate and Novawrap surfaces may be cleaned with a damp cloth and ordinary soap or non-abrasive household liquid detergent. Dry the surface with a clean cloth or soft paper towel to prevent streaks from appearing.

## Care and Maintenance of Metal

Metal surfaces can be wiped with a damp cloth and rubbed dry. A mild non-abrasive household liquid detergent can be used if necessary. Regular maintenance of metal components, including tightening of fasteners and light lubrication of moving parts, will extend the life of your furniture.

## Satin Etched Glass

Glass color may vary slightly on multi-piece conference table tops over 180" x 60" when satin etched glass is specified due to the iron content and etching process of the glass.

## Care and Maintenance of Glass

Clear or frosted glass may be cleaned with commercial glass cleaner. Be sure to use a lint-free cloth if cleaning the frosted side of the glass.

## Stone and Solid Surface Material

Despite its reputation for durability, natural stone can easily be broken during handling and/or installation if proper techniques are not followed. In addition, Nucraft is not responsible for the installation of natural stone or solid surface materials on its products. Therefore, installers specifically trained in the installation of these materials must be utilized to ensure a quality installation. Nucraft shall not be liable for any damages incurred during the handling and/or installation of natural stone or solid surface materials on its products.

## Care and Maintenance of Granite

Granite surfaces may be cleaned with a damp cloth and ordinary soap or non-abrasive household liquid detergent. Dry the surface with a clean cloth or soft paper towel to prevent streaks from appearing.

## Care and Maintenance of Leather

Genuine leather requires very little care. Nucraft recommends that leather be dusted regularly. If a more thorough cleaning is needed, use lukewarm water and a mild, non-abrasive soap. Generate some lather and lightly rub the surface with cheesecloth. Rinse off any soap film with clean water and towel dry. The leather may dry dull. To restore the leather to a normal gloss, rub it with a clean towel. Never use furniture polish, oil, varnish or ammonia. Saddle soap may be used to prevent the leather from becoming brittle or cracked and to maintain the original supple finish.

## Touch Up Finish Kits

Model #	Description	Price
KIT-M	Metal Kit	85
KIT-P	Paint Kit	85
KIT-S	Stain Kit	85

### REQUIRED INFORMATION:

#### (ORDER CANNOT BE ENTERED WITHOUT THIS INFORMATION)

- Kit model number
- Quantity of kits
- Specify finish (See pages vi-vii)

### General Information:

- Touch-up kits must be ordered on a purchase order separate from Nucraft product due to Hazmat shipping

### Retrofit & Replacements

If needing a partial placement or retrofit solution, please reach out to our quote team. Grain/color matched in a set.





# FLOW™ CREDENZA SURFACE MATERIALS

## WOOD FINISHES

### STANDARD

Default veneer sheen will vary per finish and were determined by a team of experts who reviewed the colorways to determine if gloss or matte best highlighted the natural characteristics of the species of wood and the color of the stain. Default finish is bolded. If no direction is provided, default sheen will be selected.

	Matte	Gloss
<b>Rift Cut Oak</b>		
Carbon	M03	<b>G03</b>

<b>Flat Cut Oak</b>		
Dune	<b>M05</b>	G05
Portobello	<b>M7413</b>	G7413

<b>Flaky Oak</b>		
Sahara	<b>M61</b>	G61

<b>Cherry</b>		
Cognac	M21	<b>G21</b>
Auburn	M93	<b>G93</b>

<b>Walnut</b>		
Marron	<b>M35</b>	G35
Mocha	<b>M33</b>	G33
Zinc	M30	<b>G30</b>
Onyx	M82	<b>G82</b>
Otter	M31	<b>G31</b>

<b>Maple</b>		
Natural Maple	M60	<b>G60</b>

<b>Linea</b>		
Oak Linea	<b>M08</b>	G08
Walnut Linea	<b>M27</b>	G27
Euro Birch Linea	<b>M09</b>	G09
Silver Birch Linea	M10	<b>G10</b>

<b>Paldao</b>		
Thicket	<b>M75</b>	G75
Paldao	<b>M76</b>	G76
Canyon	M77	<b>G77</b>

### PLANK

Plank offers dramatic variations in veneer leaf color, length, and natural characteristics; it simulates randomly matched veneers

	Matte	Gloss
<b>Plank Walnut</b>		
Clear Coat	M38	<b>G38</b>

## METAL FINISHES

### Powder Coat

Aged Bronze	A8010
Black	A44
Burnished	A8009
Cloud	A8004
Foil	A8006
Galaxy	A8007
Moonlight	A87
Satin Bronze	A8011
Shadow	A8005
Storm	A8012

### Metal

Clear Anodized	CA
Polished Chrome*	PC

\*Up-Charge applies.

## PAINTS

Aged Bronze	S8010
Black	S44
Burnished	S88
Cloud	S8004
Foil	S8006
Galaxy	S8007
Moonlight	S87
Satin Bronze	S8011
Shadow	S8005
Storm	S8012

### Paint to Match

To request a custom paint color, contact NUCRAFT Customer Service. A paint sample must be matched and approved prior to order.



## STONE TOPS

Stone orders may affect lead times. Please contact Nucraft Customer Service for details.

Stone		Subtop Paint Color
Absolute Black Honed Granite	ST01	S8007
Carrara Marble	ST16	S8004

## Quartz | Cambria® Signature

Ainsley	STC100	S8004
Armitage	STC101	S44
Avalene	STC192	S8004
Bellingham	STC102	S8004
Berkeley	STC103	S8004
Berwyn	STC104	S8004
Blackbrook	STC105	S44
Bradshaw	STC106	S8004
Bradwell	STC107	S8004
Cambria Black	STC109	S44
Carrick	STC110	S44
Clifton	STC112	S8004
Colton	STC113	S8004
Copeland	STC200	S8004
Crowndale	STC114	S8004
Devon	STC115	S44
Fairbourne	STC116	S8004
Fieldstone	STC117	S44
Hadley	STC201	S8004
Halewood	STC119	S8004
Hermitage	STC120	S8004
Kendal	STC122	S8004
Laneshaw	STC124	S44
MacBeth	STC202	S8004
Malvern	STC125	S8004
Montgomery	STC128	S8004
New Quay	STC130	S8004
Pendle Hill	STC131	S8004
Praa Sands	STC132	S8004
Ridgegate	STC203	S8004
Rose Bay	STC133	S8004
Sandgate	STC135	S8004
Seacourt	STC204	S8004
Smithfield	STC136	S8004
Sutherland	STC138	S8004
Swanbridge	STC139	S8004
Torquay	STC140	S8004
Trafalgar	STC205	S8004
Travella	STC141	S8004
Weybourne	STC143	S8004
Whitendale	STC206	S8004
Whitney	STC144	S8004
Woodcroft	STC146	S44

## Quartz | Cambria® Luxury

Abbey	STC147	S8004
Annaleigh - Luxe	STC193	S8004
Annicca	STC148	S8004
Beckington	STC150	S8004
Bentley	STC151	S8004
Blackpool Matte	STC152	S44
Brighton	STC212	S8004
Brittanicca	STC153	S8004
Brittanicca Gold Cool	STC154	S8004
Brittanicca Gold Warm	STC155	S8004
Brittanicca Warm	STC156	S8004
Clovelly	STC158	S8004
Delamere	STC159	S44
Delgatie	STC160	S8004
Ella	STC161	S8004
Everleigh	STC162	S8004
Everleigh Warm	STC191	S8004
Gladstone	STC163	S8004
Golden Dragon	STC164	S44
Hailey	STC165	S8004
Harlow	STC166	S8004
Hemsworth	STC167	S8004
Huntley	STC168	S8004
Inverness Blakeley	STC190	S8004
Inverness Bristol Bay	STC169	S8004
Inverness Bronze	STC170	S8004
Inverness Cobalt	STC171	S8004
Inverness Everleigh	STC172	S8004
Inverness Frost	STC196	S8004
Inverness Gold	STC197	S8004
Inverness Platinum	STC173	S8004
Inverness Swansea	STC174	S8004
Ironsbridge	STC175	S8004
Iverness Frost	STC176	S8004
Iverness Gold	STC177	S8004
Lakedale	STC179	S8004
Mayfair	STC181	S8004
Mersey	STC182	S44
MonTajaj - Luxe & Satin	STC199	S8004
Notting Hill	STC183	S8004
Oakleigh	STC184	S8004
Portrush	STC185	S8004
Queen Anne	STC186	S8006
Remington Brass Satin	STC210	S44
Remington Steel Satin	STC211	S44
Skara Brae	STC187	S8004
Southport	STC188	S8004
White Cliff	STC189	S8004

## Quartz | Wilsonart

Carrara Codena	ST21	S8004
Serene	ST17	S8004



## SOLID SURFACE TOPS

Available on round tables and credenza tops only

Wilsonart Designer White ST11

## GLASS (SATIN OR GLOSS)

	Satin	Gloss
Black	BS	-
Clove	VS	VG
Meringue	MS	MG
Moonlight	MLS	MLG
Quill	QS	QG
Storm	STS	STG
White	WS	WG

Note: Due to color variation inherent in the natural acid etching process, Satin Etched Glass is not available on tables longer than 180" or wider than 60"

## LAMINATES

	Code	Coordinating Veneer Case Wood Edge Finish	Coordinating Woodgrain Edgeband
<b>Wood Grain Laminates</b>			
Formica White Ash	8841-58	M8841	R8841
Formica Natural Ash	8843-58	M8843	R8843
Formica Aged Ash	8844-58	M8844	R8844
Formica Weathered Ash	8842-58	M8842	R8842
Formica Oiled Legno	8846-58	M8846	R8846
Formica Bleached Legno	8845-58	M8845	R8845
Formica Blackened Legno	8848-58	M8848	R8848
Formica Urban Planked Oak	9312-58	M9312	R9312
Formica Thermo Walnut	6402-58	M6402	R6402
Formica Smoky Brown Pear	5488-58	M5488	R5488
Formica Espresso Pear	5489-58	M5489	R5489
Formica Pecan Woodline	5883-58	M5883	R5883
Formica Chestnut Woodline	5884-58	M5884	R5884
Formica Sand Maple	9237-58	G60	W7909
Formica Planked Coffee Oak	7413-58	M7413	F7413

	Code	Matching ABS Edgeband
<b>Solid Laminates</b>		
Formica Brite White	459-58	R01
Formica Dover White	7197-58	R01
Formica Pearl	934-58	R02
Formica Graystone	464-58	R02
Formica Folkstone	927-58	R03
Formica Graphite	837-58	R05

	Code	Matching ABS Edgeband
<b>Patterned Laminates</b>		
Nevamar Cool Chic	VA7002T	R02
Nevamar Serene Stardom	VA5001T	R05
Nevamar Calm Distinction	VA6001T	R05
Nevamar Easy Elegance	VA5002T	R05
Wilsonart Sheer Mesh	4876-38	R02
Wilsonart Grey Mesh	4877-38	R02
Wilsonart Pewter Mesh	4878-38	R05

## ABS FINISHES

Ashen	R04
Parchment	R02
Shale	R05
Stone	R03
Whitecap	R01