

CROSSBEAM™

Planning Guide + Price List

QUICK LINKS

[PLANNING GUIDE](#)

[CROSSBEAM PRICING](#)

[POWER AND DATA OPTIONS](#)

[GENERAL INFORMATION](#)

[FINISH INFORMATION](#)

[SURFACE MATERIALS](#)



TABLE OF CONTENTS

Click the shortcuts below to jump to each section.

General Information	ii-iii
Finish Information	iv-v
Surface Materials	vi-viii
Specification Overview	3
Planning Guide	4
Price List	13-17
Rectangle Table With Power Drawer	13-14
Rectangle Table Without Power Drawer	15
Power and Data Options	16-17

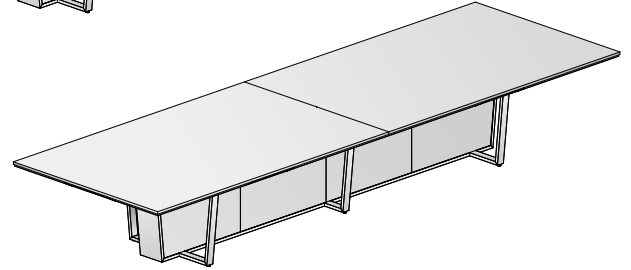
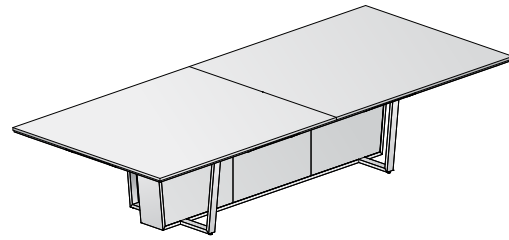



SPECIFICATION OVERVIEW

1. Select the Table Size

Crossbeam tables are available from 120" to 240" in length.

2. Select the Top Material and Edge Profile

Crossbeam tables are available with laminate, veneer, glass, solid surface and stone top options. Edge profile options are Square and Knife edge.

3. Select the Metal Finish

Crossbeam metal elements can be specified in a variety of powder coated finishes.

4. Select the Center Base Material

The center base of Crossbeam tables features removable panels to access the interior cavity of the base. These panels can be specified with veneer, paint, laminate, Chemetal or acrylic finishes.

5. Select the Power Option (Optional)

Crossbeam tables can be specified with or without power. Power options include:

- Table top: Power Matrix (Compact version) can be specified in a variety of locations and quantities
- Below Table top: Power Drawers, the quantity and locations of which are pre-determined based on table size.



DETAIL OVERVIEW

CROSSBEAM TABLE

With its attention to detail, the Crossbeam table provides a fresh angle on premium conference room products. Designed for large group gatherings, high-end formal conference rooms and board rooms, this table brings inspiration and sophistication to any conference room.

Center Base

The center base on Crossbeam provides a substantial visual element, robust in length while at the same time narrow in width. This design hides cables, stores technology and covers floor outlets delivering building power and AV connections. Side panels are offered in veneer, paint, laminate, Chemetal and acrylic options for a broad aesthetic variety.

Cross Legs

In contrast to the strong visual of the center base, the metal cross legs on Crossbeam are much lighter in visual appearance, offering a dichotomy in scale on the same table. The cross legs are available in a wide range of powder coat options and are spaced to always fall between chairs based on the seating capacity for each table size.

Edge Profiles

Crossbeam tables are available with two edge profile options, square and knife, offering alternate aesthetic options for a thicker or thinner appearance (excluding solid surface and glass tops).

Power Drawers

Discreetly incorporated into the apron of the table, Power Drawers provide convenient yet covert access to power and AV connectivity while leaving the table surface uninterrupted. The quantity of Power Drawers per table is determined based on the size of the table.

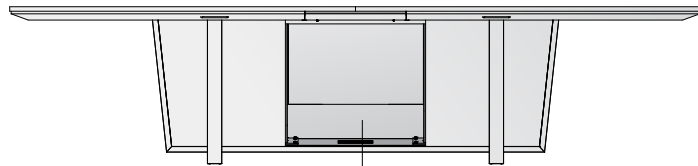
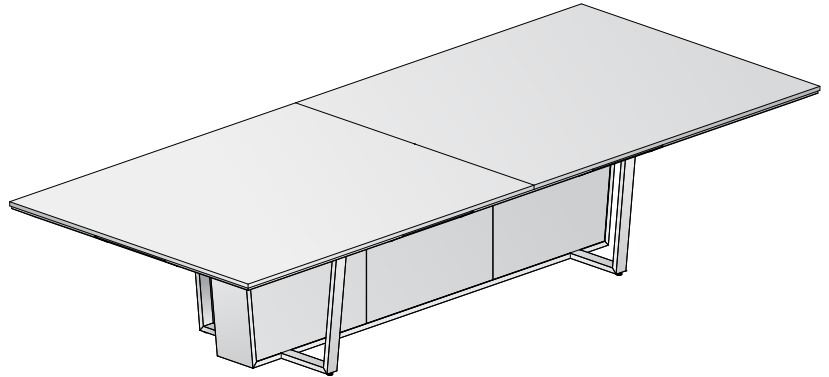

Side panels are removable for internal storage

Square Edge Profile

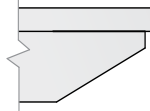

Knife Edge Profile

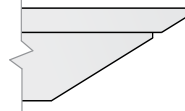

Crossbeam Table with Power Drawers

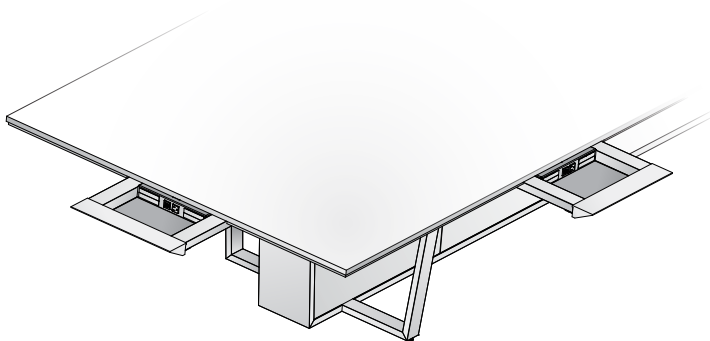



UNDER SURFACE POWER OPTION: POWER DRAWER

POWER DRAWERS

Discreetly incorporated into the apron of the table, Power Drawers provide convenient yet covert access to power and AV connectivity while leaving the table surface uninterrupted. The quantity of Power Drawers per table is determined based on the size of the table. The drawer front features the same profile as the apron, allowing it to blend seamlessly into the table design so technology is unobtrusive. Power drawers pull out 11 inches beyond the edge of the table. A small gap at the top of the drawer front allows the drawer to be closed while cables are connected to devices on the table top. Connectivity options includes power (simplex and charging USB-A+C) as well as Extron Architectural Adaptor Plates (AAPs) for easy customization of AV connectivity. The leather-lined drawers also provide storage for extra cables or other items.

When Power Drawers are specified, Crossbeam tables include a modular electrical system within the center base of the table, allowing for a single point of connection to building power. This connection can be either hardwired or corded (which requires a 20-amp power outlet in the floor monument), both of which are included with the table. See page 12 for more information on this electrical system.

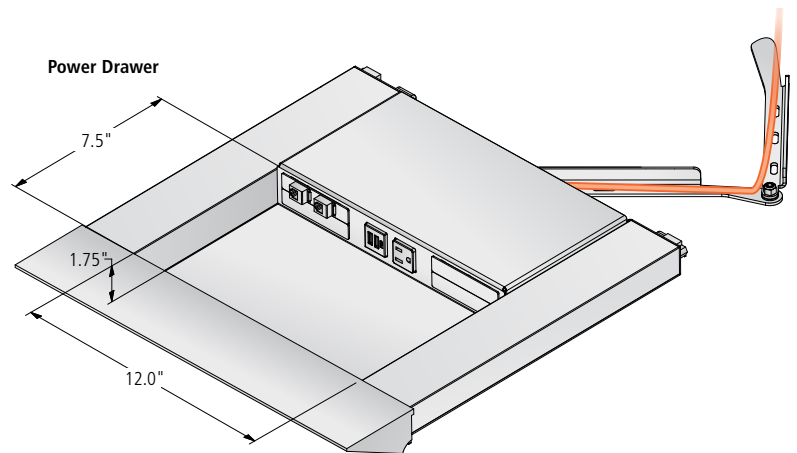

Power Drawer Dashboard

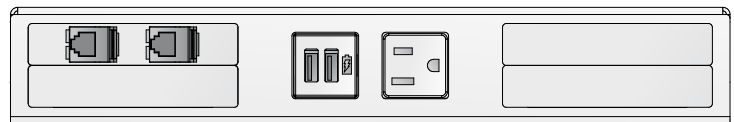

Wire Management Gap Between Table Top and Power Drawer

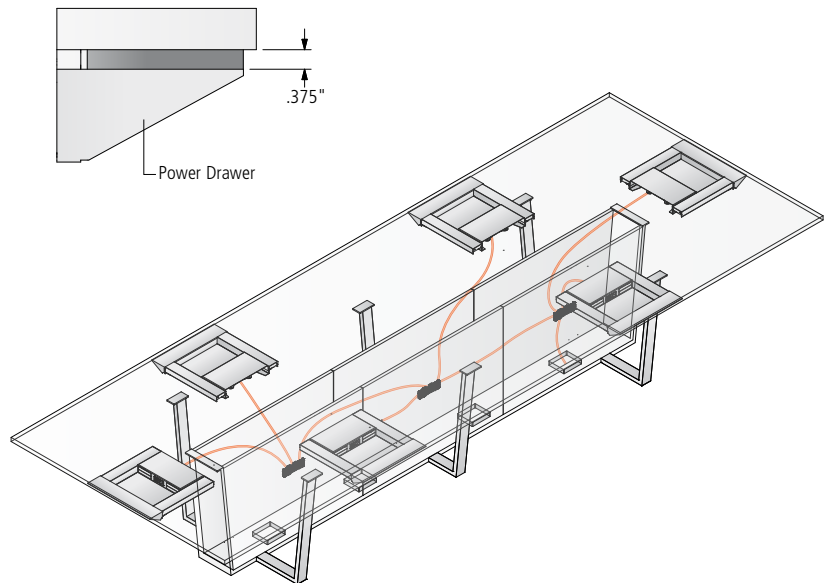

POWER DRAWERS PER TABLE SIZE

The quantity of Power Drawers per table is determined based on the size of the table.

TABLE SIZE	SEATING CAPACITY	POWER DRAWERS PER TABLE	POWER DRAWERS PER LONG SIDE	POWER DRAWERS PER END	TOTAL # OF RECEPTACLES	TOTAL # OF USB-A+C PORTS	TOTAL # OF RJ-45 CONNECTORS	BLANK FACEPLATES
120 x 60	10	4	1 per side	1 per end	4	8	8	12
144 x 60	12	6	2 per side	1 per end	6	12	12	18
168 x 60	14	6	2 per side	1 per end	6	12	12	18
192 x 60	16	6	2 per side	1 per end	6	12	12	18
216 x 60	18	10	4 per side	1 per end	10	20	20	30
240 x 60	20	10	4 per side	1 per end	10	20	20	30



TABLE TOP POWER OPTION: POWER MATRIX COMPACT

For table top access, Power Matrix is offered in various quantities based on table length and location choice.

POWER

Power Matrix units feature one simplex receptacle and a USB-A+C charger for power connectivity. Where more power is desired and AV connectivity is not required, an optional version includes three simplex receptacles and a USB-A+C charger with no Extron AAPs (see below).

DATA/AV FACEPLATES

Power Matrix includes three Extron Architectural Adaptor Plates (AAPs) for unparalleled flexibility in data and AV connectivity. One faceplate includes two RJ-45 (Data) connectors and two faceplates are blank. Optional faceplates provide a wide range of AV connectivity choices.

DESIGN

Power Matrix units feature a clear anodized aluminum body and a bezel-free flush mount design on wood tables for an elegant appearance. Laminate, solid surface, stone, and glass table tops include a bezel, available in powder coat, polished chrome, blackened nickel plating, or clear anodized finish options.

PERFORMANCE

Friction hinges ensure smooth travel through the door's range of motion and can hold the door in any position. Hidden door stops maintain the minimalist aesthetic. Cable storage is both concealed and ample.

DOORS

Power Matrix is offered in multiple door material options, including metal, glass and grain-matched wood cut from the same table top.

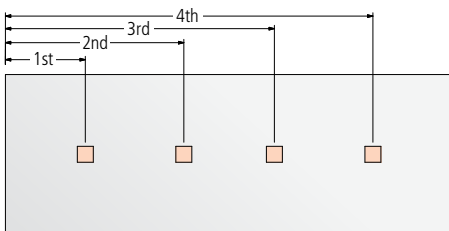
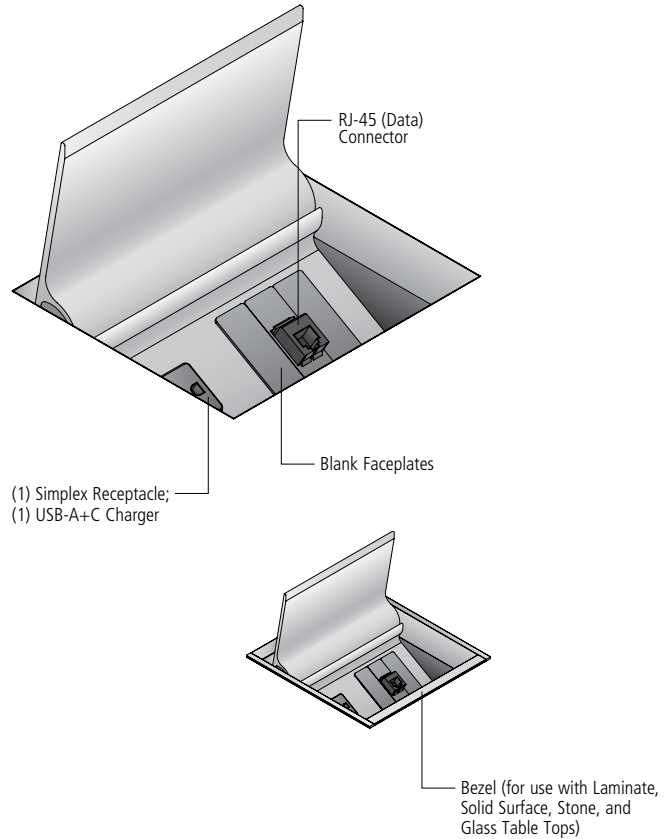

Power Matrix Locations

Table Length (inches)	Center of 1st Power Matrix	Center of 2nd Power Matrix	Center of 3rd Power Matrix	Center of 4th Power Matrix
120	29	-	-	91
144	29	54	90	115
168	29	72	96	139
192	29	72	120	163
216	29	90	126	187
240	29	72	168	210



TABLE TOP POWER OPTION: POWER MATRIX COMPACT

STANDARD CONFIGURATION

Power Matrix is offered with a pre-determined quantity of simplex outlets and AV faceplates. An optional dual 2 amp USB-A charger (1 amp per port) replaces one of the simplex outlets.

Compact

- Single door design
- 5.375" x 6" cutout
- Two simplex outlets
- Three AV faceplates. Standard configuration includes two blank faceplates and one faceplate with two RJ-45 (data) connectors.
- (1) 12' plug-in infeed cord

Standard Configuration

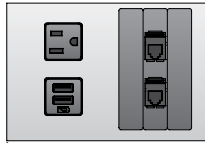

Optional Configuration

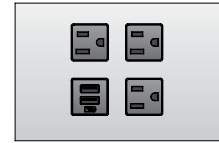

DIMENSIONS

The compact Power Matrix unit includes a low-profile pan beneath the work surface to conceal the unit.

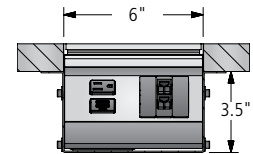
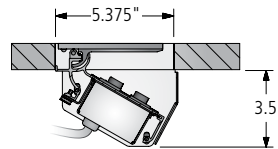

LOCATIONS

Power Matrix units can be specified with one at each end, or four equally spaced.

MODULAR ELECTRICAL SYSTEM

When Power Matrix units are specified, Crossbeam tables include a modular electrical system within the center base of the table, allowing for a single point of connection to building power. This connection can be either hardwired or corded (which requires a 20-amp power outlet in the floor monument), both of which are included with the table. See page 12 for more information on this electrical system.

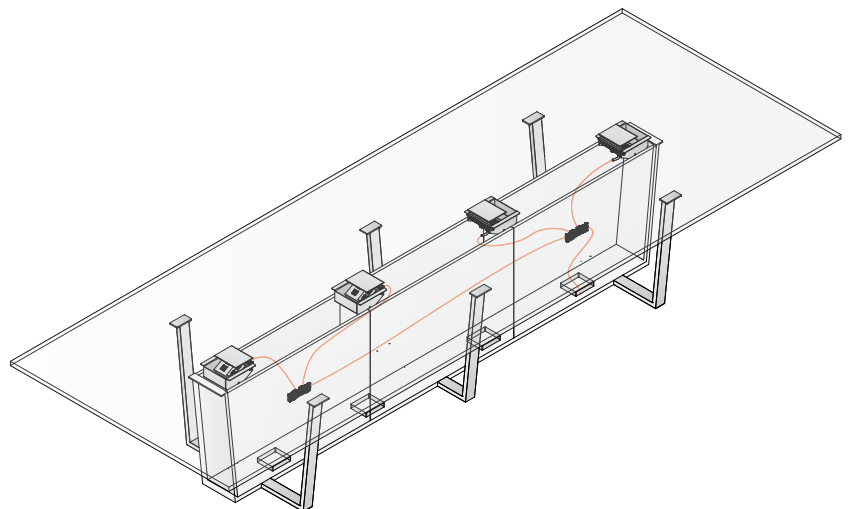



WIRE MANAGEMENT

PRE-WIRED ELECTRICAL SYSTEM

With Crossbeam, connections to building power include hardwired or direct plug-in infeed options, both of which are included with the table. Key elements of the pre-wired electrical system include:

- 4-wire, 20-amp modular electrical system
- All tables are pre-wired on a single circuit
- When connected to building power via the direct plug-in infeed, a 20-amp outlet is required. The direct plug-in infeed is 84" long.
- When connected to building power via the hardwired infeed, a licensed electrician is required to complete the hardwire connections to the building's power source. The hardwire power infeed is 84" long.
- Neutral (white) wires are 10 gauge, hot and ground wires are 12 gauge
- All electrical components satisfy National Electrical Code (NEC) requirements and are UL listed

Electrical Diagram — Hardwire Power Infeed Only

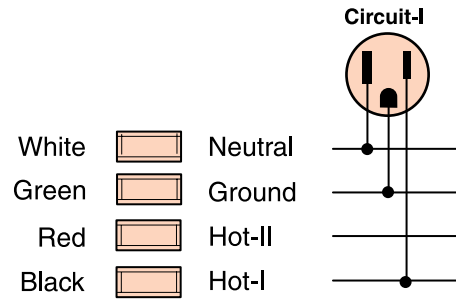

FIELD-WIRED

Some local electrical codes may require field-wiring during installation. In such instances, a Field-Wired option may be specified. In this configuration, each Power Matrix unit will be supplied with a 6' conduit with hot, ground and neutral wires.

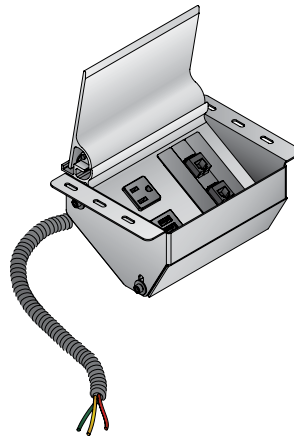



BASE CUT-OUT LOCATIONS

Crossbeam's center base provides multiple locations from which building power (floor cores) can be accessed. The location of these 5" x 5" square cut-outs, as measured from the end of the table, vary based on table length and are documented in the drawings below.

120" Tables

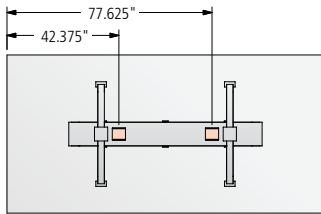

192" Tables

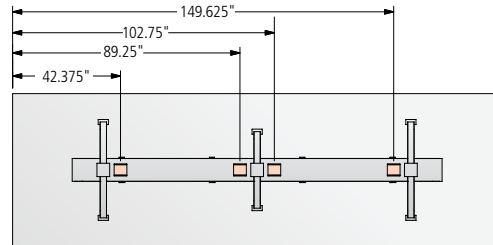

144" Tables

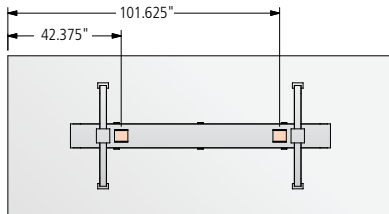

216" Tables

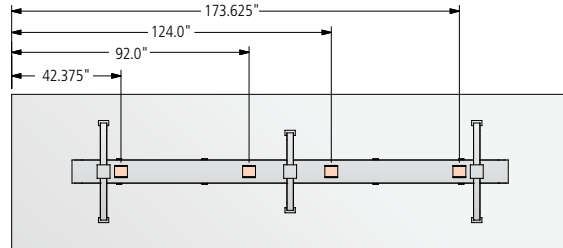

168" Tables

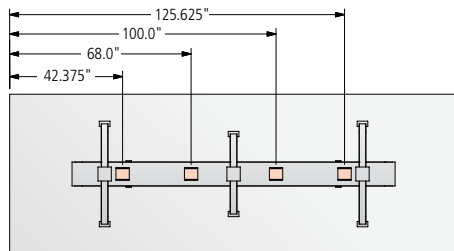

240" Tables

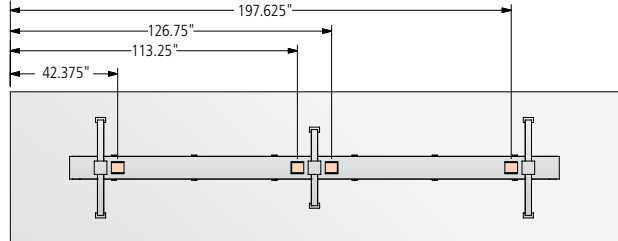



INTERNAL CLEARANCE DIMENSIONS

120" Tables

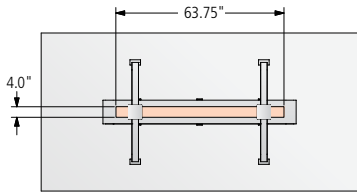

192" Tables

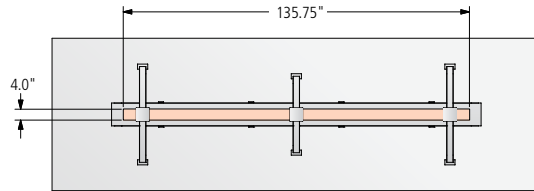

144" Tables

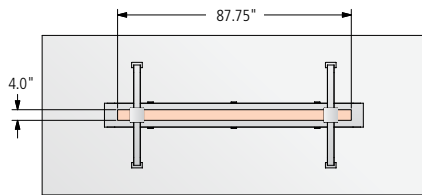

216" Tables

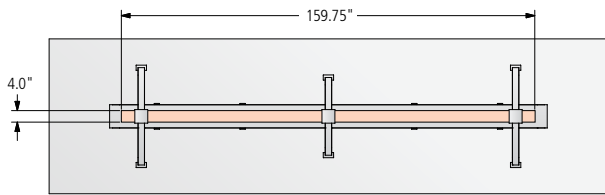

168" Tables

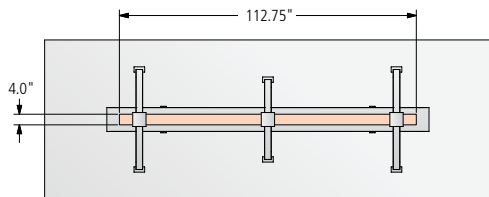

240" Tables

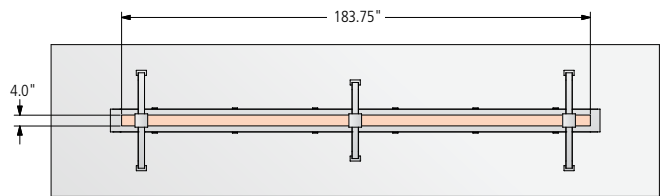
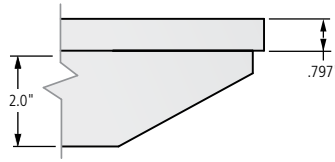



TABLE TOP EDGE PROFILE STYLES

Crossbeam tables are available with two edge profile options, square and knife, offering alternate aesthetic options for a thicker or thinner appearance on veneer, laminate and stone tops. Glass and solid surface tops have one edge profile each.

Veneer or Laminate Square Edge



Veneer or Laminate Knife Edge

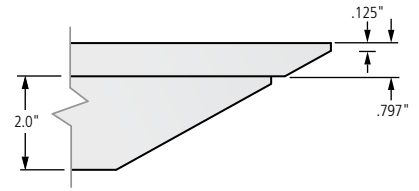

Stone Square Edge

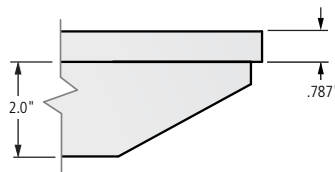

Stone Knife Edge

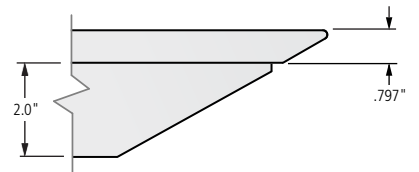

Glass Square Edge

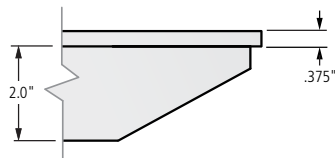

Solid Surface Square Edge

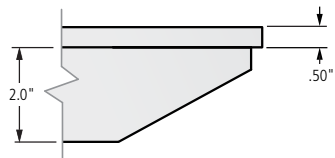



SEATING CAPACITY

RECTANGLE TABLES

Note: Seating capacity is based on 27" per person.

120" Seating Capacity

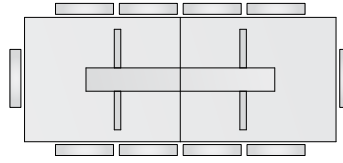

144" Seating Capacity

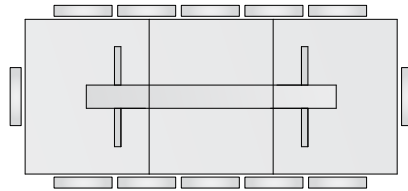

168" Seating Capacity

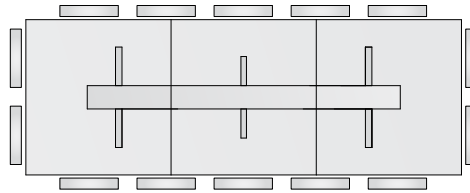

192" Seating Capacity

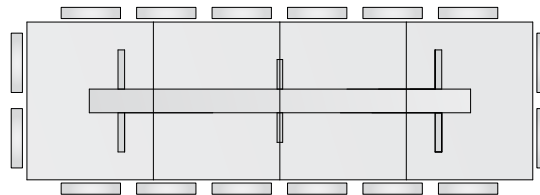

216" Seating Capacity

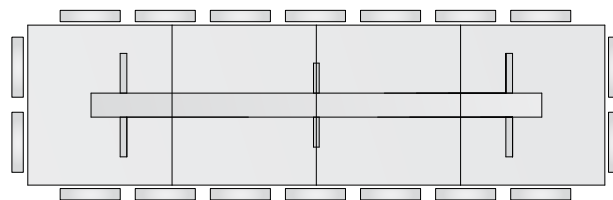

240" Seating Capacity

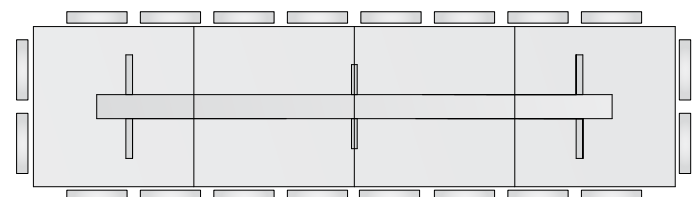



RECTANGLE TABLE WITH POWER DRAWER

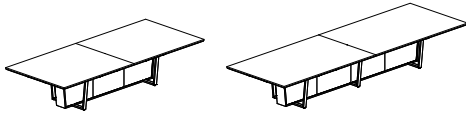

TOP MATERIAL KEY

PE	Laminate with ABS Edge Top
P	Inset Laminate with Hardwood Edge Top
V	Veneer Top
G	Glass Top
SS	Solid Surface Top
S	Stone Top

RECTANGLE

MODEL #	L x W	LAMINATE & VENEER TOP SECTIONS	GLASS & SOLID SURFACE TOP SECTIONS	STONE TOP SECTIONS	CROSS LEG QTY	SEATING CAPACITY	POWER DRAWERS	-PE	-P	-V	-G	-SS	-S
CMT-12060-PD []	120 x 60	1	2	2	4	10	4	27,758	28,848	30,179	36,233	37,444	48,341
CMT-14460-PD []	144 x 60	2	2	3	4	12	6	34,443	35,718	37,276	44,359	45,775	58,524
CMT-16860-PD []	168 x 60	2	2	4	6	14	6	36,611	37,994	39,684	47,369	48,906	62,738
CMT-19260-PD []	192 x 60	2	3	4	6	16	6	38,517	39,995	41,802	50,016	51,659	66,444
CMT-21660-PD []	216 x 60	2	3	4	6	18	10	48,465	50,143	52,193	61,514	63,378	80,156
CMT-24060-PD []	240 x 60	2	3	5	6	20	10	51,243	53,059	55,279	65,372	67,390	85,556

[] Specify Base Panel Material: List of materials available under Options section

OPTIONS	CODE	PRICE	NOTES
Center Base Panel Finish:			
Bronze Mirrored Acrylic Center Base Panel	Add -MABP	\$2,257 for 120"-144" tables \$3,386 for 168"-192" tables \$4,512 for 216"-240" tables	
Chemetal Center Base Panel	Add -CBP	\$3,477 for 120"-144" tables \$5,213 for 168"-192" tables \$6,951 for 216"-240" tables	
Paint	Add -PBP	No charge	
Veneer	Add -VBP	No charge	
Polished Chrome Base:			
120" - 144"-Long Tables	Add -PCMB4	\$5,652	
168" - 240"-Long Tables	Add -PCMB6	\$8,470	
Satin Glass:			
120"-Long Tables	Add -CSG1	\$778	
144"-Long Tables	Add -CSG2	\$1,163	
168"-Long Tables	Add -CSG3	\$1,553	
Field Wiring:			
Field-Wired Power Drawers	Add -FWPD	No charge	

GENERAL INFORMATION

- Each Power Drawer includes one simplex receptacle, one USB-A+C charger and four single-height Extron AAP faceplates. One faceplate includes dual RJ45 connectors and three faceplates are blank.
- Each Power Drawer is leather lined. Choose from Spinneybeck Vicenza color options. If an option is not specified, the leather will default to Costozza VZ2116
- Power Drawer connection can be either hardwired or corded (which requires a 20-amp power outlet in the floor monument), both of which are included with the table
- Apron is painted to match the metal finish specified on the table.
- Base panels default based on the top material selected unless otherwise specified. The default for Veneer is Veneer panels. The default for Laminate, Stone, Solid Surface or Glass tops is Paint.
- This connection can be either hardwired or corded (which requires a 20-amp power outlet in the floor monument), both of which are included with the table.



RECTANGLE TABLE WITH POWER DRAWER

**REQUIRED INFORMATION (ORDER CANNOT BE ENTERED WITHOUT THIS INFORMATION)
MUST SPECIFY TABLE TOP FINISH, METAL LEG FINISH, CENTER BASE PANEL FINISH AND INFEEED**

See pages 5-6 for surface material options.

- Choose Wood Species and Finish, if -P or -V top material selected
- Choose Laminate Finish, if -PE or -P top material selected
- Choose ABS Finish, if -PE top material selected
- Choose Glass Finish, if -G top material selected
- Choose Solid Surface Finish, if -SS top material selected
- Choose Stone Finish, if -S top material selected
- Choose Metal Finish
- Choose Chemetal Finish, if -CBP option selected
- Choose Paint Finish for center base panels, if -PBP option selected
- Choose Veneer Finish for center base panels, if -VBP option selected
- Choose Leather for Interior of Power Drawers - Choose from Spinneybeck Vicenza color options. (If not specified, default is Costozza VZ2116)
- Choose Edge Profile:



-CSQ
Crossbeam Square Edge

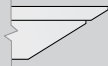

-CKN
Crossbeam Knife Edge

POWER DRAWER

POWER DRAWERS PER TABLE SIZE

TABLE SIZE	SEATING CAPACITY	POWER DRAWERS PER TABLE	POWER DRAWERS PER LONG SIDE	POWER DRAWERS PER END	TOTAL # OF RECEPTACLES	TOTAL # OF USB-A+C PORTS	TOTAL # OF RJ-45 CONNECTORS	BLANK FACEPLATES
120x60	10	4	1 per side	1 per end	4	8	8	12
144x60	12	6	2 per side	1 per end	6	12	12	18
168x60	14	6	2 per side	1 per end	6	12	12	18
192x60	16	6	2 per side	1 per end	6	12	12	18
216x60	18	10	4 per side	1 per end	10	20	20	30
240x60	20	10	4 per side	1 per end	10	20	20	30

*Power Drawer cannot be located at the center of the long side of a Crossbeam table due to center base placement



RECTANGLE TABLE WITHOUT POWER DRAWER

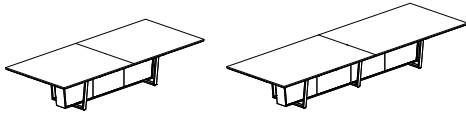

TOP MATERIAL KEY

- PE Laminate with ABS Edge Top
- P Inset Laminate with Hardwood Edge Top
- V Veneer Top
- G Glass Top
- SS Solid Surface Top
- S Stone Top

RECTANGLE

MODEL #	L x W	LAMINATE & VENEER TOP SECTIONS	GLASS & SOLID SURFACE TOP SECTIONS	STONE TOP SECTIONS	CROSS LEG QTY	SEATING CAPACITY	-PE	-P	-V	-G	-SS	-S
CMT-12048[]	120 x 48	1	2	2	4	10	18,230	19,141	20,255	25,319	26,332	35,447
CMT-14460[]	144 x 60	2	2	3	4	12	25,497	26,772	28,330	35,413	36,829	49,578
CMT-16860[]	168 x 60	2	2	4	6	14	27,665	29,048	30,738	38,423	39,960	53,792
CMT-19260[]	192 x 60	2	3	4	6	16	29,571	31,049	32,856	41,070	42,713	57,498
CMT-21660[]	216 x 60	2	3	4	6	18	33,555	35,233	37,283	46,604	48,468	65,246
CMT-24060[]	240 x 60	2	3	5	6	20	36,333	38,149	40,369	50,462	52,480	70,646

[] Specify Base Panel Material: List of materials available under Options section

OPTIONS	CODE	PRICE	NOTES
Center Base Panel Finish:			
Bronze Mirrored Acrylic Center Base Panel	Add -MABP	\$2,257 for 120"-144" tables \$3,386 for 168"-192" tables \$4,512 for 216"-240" tables	
Chemetal Center Base Panel	Add -CBP	\$3,477 for 120"-144" tables \$5,213 for 168"-192" tables \$6,951 for 216"-240" tables	
Paint	Add -PBP	No charge	
Veneer	Add -VBP	No charge	
Polished Chrome Base:			
120" - 144"-Long Tables	Add -PCMB4	\$5,652	
168" - 240"-Long Tables	Add -PCMB6	\$8,470	
Satin Glass:			
120"-Long Tables	Add -CSG1	\$778	
144"-Long Tables	Add -CSG2	\$1,163	
168"-Long Tables	Add -CSG3	\$1,553	

POWER & DATA OPTIONS

See pages 20-21 for power and data options.

GENERAL INFORMATION

- Apron is painted to match the metal finish specified on the table. If Polished Chrome metal is specified for the legs, the apron will default to Foil.
- Base panels default based on the top material selected unless otherwise specified. The default for Veneer is Veneer panels. The default for Laminate, Stone, Solid Surface or Glass tops is Paint.

REQUIRED INFORMATION (ORDER CANNOT BE ENTERED WITHOUT THIS INFORMATION) MUST SPECIFY TABLE TOP FINISH, METAL LEG FINISH, CENTER BASE PANEL FINISH AND INFEEED

- See pages 5-6 for surface material options.
- Choose Wood Species and Finish, if -P or -V top material selected
 - Choose Laminate Finish, if -PE or -P top material selected
 - Choose ABS Finish, if -PE top material selected
 - Choose Glass Finish, if -G top material selected
 - Choose Solid Surface Finish, if -SS top material selected
 - Choose Stone Finish, if -S top material selected
 - Choose Metal Finish
 - Choose Chemetal Finish, if -CBP option selected
 - Choose Paint Finish for center base panels, if -PBP option selected
 - Choose Veneer Finish for center base panels, if -VBP option selected
 - Choose Edge Profile:

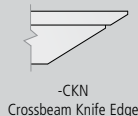
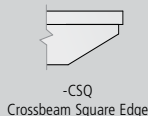



POWER AND DATA OPTIONS

DATA/AV FACEPLATES

POWER MATRIX - COMPACT	MODEL #	DESCRIPTION	W x D	SIMPLEX OUTLETS	BLANK	DATA*	PRICE
	PM-SM-G-C	Compact - Glass Door	6 x 5.375	2	2	1	1,549
	PM-SM-M-C	Compact - Metal Door	6 x 5.375	2	2	1	1,549
	PM-SM-W-C	Compact - Wood Door	6 x 5.375	2	2	1	1,954

*Each data faceplate includes two RJ-45 (Data) connectors

OPTIONS	CODE	PRICE	NOTES
4 Simplex Receptacles	Add -FOUR	No Charge	Replace AAP's with 2 additional simplex receptacles
3 Simplex Receptacles/Charging USB-A+C	Add -THREE-C	No Charge	Replace AAP's with 1 additional simplex receptacle and 1 charging USB-A+C
USB-A+C Charging	Add -USB-C	\$121 per unit	USB-A+C charger, replaces one of the simplex outlets
Polished Chrome Door	Add -PD	\$232 per unit	Only available with metal door option
Polished Chrome Bezel	Add -PB	\$330 per unit	Only available on glass, stone/quartz, solid surface and laminate top tables
Field-Wired	Add -FW	Deduct \$45 per unit	May be required in New York City, Chicago and San Francisco. Check with an electrician for local codes and requirements.

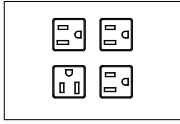
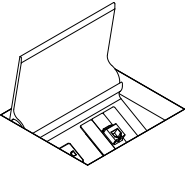

-FOUR

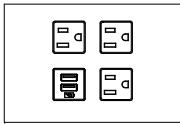

-THREE-C

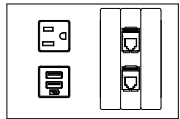

-USB-C

GENERAL INFORMATION

- Wood species and finish will default to the same as the table top if wood door version is specified
- Glass & wood doors are 1/4" -thick, metal doors are 1/8" -thick
- Glass door is back painted low-iron glass
- Interior body is clear anodized aluminum
- Power Matrix connection can be either hardwired or corded (which requires a 20-amp power outlet in the floor monument), both of which are included with the table
- If Field-Wired option is specified, each unit includes a 6' flexible metal conduit and requires a hardwire connection
- Standard configuration: Two simplex receptacles, two RJ-45 data connectors and two single blank faceplates
- When specified on tables with laminate, glass, solid surface or stone tops, each Power Matrix unit will include a metal bezel and is limited to the glass and metal door options. (-B) will be added to the model number for the bezel.
- Additional data/AV faceplate options are on page 21
- This connection can be either hardwired or corded (which requires a 20-amp power outlet in the floor monument), both of which are included with the table.

REQUIRED INFORMATION: (ORDER CANNOT BE ENTERED WITHOUT THIS INFORMATION)

See pages 5-6 for surface material options.

- Choose location code & quantity from the chart below
- Choose Glass Door Finish, if glass door version is specified
- Choose Metal Finish, if metal door version is specified or for the bezel finish on laminate, glass, solid surface and stone tables

LOCATION CODES	POWER MATRIX COMPACT	LOCATION	QUANTITY OF UNITS TO ORDER
	PS-2	One at each end	2
	PS-4	Four units. See page 10 for location chart (tables 144" and longer)	4

DOOR MATERIAL AND LOCATION AVAILABILITY BY TABLE SIZE

W = Wood Door G = Glass Door M = Metal Door

Length	POWER MATRIX COMPACT	
	PS-2	PS-4
120	W/G/M	-
144	W/G/M	W/G/M
168	W/G/M	W/G/M
192	W/G/M	W/G/M
216	W/G/M	W/G/M
240	W/G/M	W/G/M



POWER AND DATA OPTIONS

AV CONNECTORS AND MOUNTING PLATES	MODEL #	DESCRIPTION	STYLE	W x H	PRICE
	FLDF-1	Blank faceplate, single height	Single	3-1/2 x 5/8	77
	FLDF-2	One VGA 15-pin HD Female to Female Gender Changer, one 3.5mm Stereo Mini Jack to Solder Tabs	Single	3-1/2 x 5/8	270
	FLDF-3	One VGA 15-pin HD Female to Female Gender Changer	Single	3-1/2 x 5/8	212
	FLDF-4	One RJ-11 Female to Punch Down - Phone	Single	3-1/2 x 5/8	212
	FLDF-5	One RJ-45 Female to Female Barrel - Data	Single	3-1/2 x 5/8	173
	FLDF-6	Two RJ-45 Female to Female Barrels, single height	Single	3-1/2 x 5/8	232
	FLDF-7	Two RJ-45 Female to Punch Down for CAT 6 - AMP	Single	3-1/2 x 5/8	328
	FLDF-8	Two RJ-45 Female to Punch Down for CAT 6 - Leviton	Single	3-1/2 x 5/8	328
	FLDF-10	Two RJ-45 Female to Punch Down for CAT 6 - Panduit	Single	3-1/2 x 5/8	328
	FLDF-11	Two USB A Female to Two USB A Female on 10" Pigtails	Single	3-1/2 x 5/8	367
	FLDF-12	Blank faceplate, double height	Double	3-1/2 x 1-3/8	96
	FLDF-13	Two RJ-45 Female to Female Barrels, double height	Double	3-1/2 x 1-3/8	232
	FLDF-14	Cable Pass-Through Set - one top, one bottom	Double	3-1/2 x 1-3/8	405
	FLDF-15	One HDMI Female to Female Barrel	Single	3-1/2 x 5/8	270

GENERAL INFORMATION

- All connectors and faceplates are Extron® Architectural Adapter Plates (AAP)
- Faceplates are black



Appendix



GENERAL INFORMATION

This price book supercedes all previous versions.

Before placing your order, confirm you have all required information necessary. Lead times for orders begin after all required information is included and correct.

Delivery Information

We know lead times are important and sticking to them even more so. We work to maintain a 6-8 week lead time on all standard products in this book from receipt of a clean order. All orders are acknowledged with an approximate shipping date and will be invoiced with the price in effect at the date the purchase order is received. For current lead times, please review www.nucraft.com/resources/lead-times.

Shipping charges are prepaid (within the continental U.S.). Therefore, pricing is a delivered price based on normal ground transportation. If you have special instructions, need to ship by air, or are shipping to Alaska or Hawaii, contact Nucraft Customer Service. Nucraft can also help arrange to have products blanket wrapped for an additional charge. Contact the Nucraft Customer Service team or specify it on your purchase order.

Minimum Freight Charge: Any order below \$2,900 net will be assessed a \$475 net minimum freight charge (one per order).

Orders are subject to acquiring the materials required for manufacturing. Fulfillment can be affected by strikes, fires, embargoes and acts of government. These elements are beyond our control.

Nucraft offers a variety of services to accommodate a wide range of delivery requirements. Availability of these services is dependent on a number of factors and may not be offered with all shipments. Examples of delivery services that have additional fees include:

- Specific date
- Specific time of day, morning or afternoon
- Delivery to a warehouse before delivery to its final destination (unless product is picked up at the warehouse)

Contact the Nucraft Customer Service team for availability and pricing on these services.

Freight Terms

Shipping charges for Nucraft products are prepaid for standard delivery in the continental United States. Standard delivery is defined as follows: Product is delivered on a 53' trailer being pulled by a long-haul tractor (total length of 85'). Facility will receive delivery Monday through Friday between the hours of 8:00 AM and 4:00 PM. Facility has docks with levelers and a fork truck for unloading. Product will be loaded on load bars two levels high. Receiving facility is responsible to have personnel on hand to unload the truck upon arrival, drivers do not unload. Delivery sites or times that do not meet these criteria may be accommodated, but will incur a charge to cover additional shipping costs. Please **notify Nucraft a minimum of two weeks prior to shipment** to arrange special services and determine additional charges.

Storage

Nucraft has no storage facilities for finished product. If a customer cannot accept an order when it is ready for shipment, the customer must designate an alternative shipping address. If no address is provided, Nucraft may, at its discretion, transfer the product to storage. If product is transferred to an off-site storage facility, the customer may be charged for transportation to the facility and for any associated storage fees. Nucraft considers transfer of the product to a storage facility the equivalent of shipment, including invoicing and payment. Customers assume the risk of damage or loss during storage.

Transportation Times and Delays

Third party carriers that Nucraft contracts with will make reasonable efforts to accommodate requested delivery times and dates. Scheduled delivery appointments may, however, be delayed for a variety of reasons, including inclement weather, traffic, transportation equipment problems, and delays encountered at other delivery locations along the delivery route. Nucraft does not recommend scheduling activities that depend on the delivery appointment (for example, scheduling furniture installers to install furniture the day of the delivery appointment). Nucraft shall not be liable for any costs incurred as a result of a missed delivery appointment.

Shipment Damage Claims

Legal title to merchandise passes to the buyer upon acceptance by the carrier. Inspect all cartons upon delivery. Details of visible damage should be noted on the delivery receipt. Do not destroy packaging, transport to site, or install product if damage is found upon inspection. Inspection of products should be completed upon delivery to the receiver. If visible damage is apparent, a claim should be filed immediately with Nucraft Customer Service. If visible damage is not apparent, sign the delivery receipt "No visible damage." This will allow recourse for a concealed damage claim. Concealed damage claims must be filed within 15 days of receipt, **prior to transporting or installing any product.**

Do not destroy packing materials until shipment has been inspected. If damage is found, proceed to file a claim with Nucraft Customer Service.

Failure to make any claims against Nucraft within 15 days shall constitute acceptance of the merchandise and a waiver of any defects, errors or shortages discovered upon inspection.

Cancellations

Cancellations must be reviewed by our Customer Service team. Because we build your products to order, orders cannot be cancelled once processing has begun. Processing includes but is not limited to development of shop drawings and other engineering drawings. If cancellation is approved, a processing fee of 20-100% will be assessed based on the status of the order.

Change Order Policy

Nucraft will make every attempt to honor any reasonable change request to product provided that the request is received prior to start of production. Change orders will be accepted only if the request is made in writing and received in time to make the change. Nucraft reserves the right to increase our acknowledged price and ship date if necessary to make the requested changes. Please submit any change order request to our Customer Service team. Nucraft will assess charges to the customer as stipulated in the following:

- Standard Orders: Change orders received prior to production will be charged \$400 net to cover administrative costs.
- Special Orders: Change orders received prior to production will be charged \$400 net to cover administrative costs. There may be additional costs associated with engineering labor required for the change order.
- Change orders received after production must be evaluated by Nucraft. If approved, the charge will be \$400 net plus any restocking charges accumulated. There may be additional costs associated with engineering and/or manufacturing labor, as well as material costs, required for the change order.



GENERAL INFORMATION

Repair Authorization

Prior written approval is required for repairs of merchandise charged to Nucraft. Failure to do so will result in customer funded repairs.

Payment Terms

Deposits are required at the time of order due to the custom nature of our products. See information regarding Cancellations above.

Credit terms are available to qualified customers. Please contact AR@Nucraft.com to start the application process. Note that the credit application process requires a valid sales tax exemption or resale tax certificate, Form W-9, and three current trade references.

Credit Card Payments are accepted via web portal. Please contact AR@Nucraft.com for payment instructions. Note that a 2% convenience fee will be added for using this payment method and no early pay discounts are allowed on credit card payments.

Warranty

Nucraft Furniture is warranted to be free from defects in materials and workmanship for a period of ten years of single shift use. Limitations include:

- Mechanical Devices such as latches, casters, and other moving components are warranted for five years of the date of original delivery.
- Height adjustable components are warranted for two years of the date of original delivery.
- The following are warranted for one year of the date of original delivery:
 - Textiles
 - Electrical Components
 - Refrigeration Units
 - Custom Products not described in Nucraft's Catalogue

This warranty is applicable only if furniture is properly installed and maintained in an office environment. This warranty extends only to products manufactured and sold in North America and only to original purchasers acquiring new Nucraft product through authorized dealers or approved sellers.

During this warranty period, Nucraft's sole obligation is to repair or replace, at Nucraft's discretion, products which prove to be defective during the warranty period.

This warranty does not cover:

- Damage caused by a carrier.
- Damage from user modification, misuse, abuse, accident, or negligence.
- Customer's Own Material (COM) specified by the customer that is not a standard product offering.
- Color, grain, or texture of wood and other covering material.

Nucraft extends no other warranties, expressed or implied, including warranty of merchantability or fitness for a particular purpose. Nucraft shall not be liable for loss of time, inconvenience, commercial loss, incidental or consequential damages.

Environmental Statement

Nucraft is committed to supporting responsible environmental policies and practices in all that we do. We strive for sustainability, weighing our business decisions against the costs to the ecological, social and economic systems they affect.

Our products are manufactured to meet the credit requirements of the U.S. Green Building Council's LEED rating systems in one or more of the following categories:

- Recycled Content
- Certified Wood
- Low-Emitting Materials

Computer Aided Planning

Nucraft products and pricing are available via CET and 2020 Cap, an AutoCAD®-based space planning tool.

2020 Cap is an integrated software system developed specifically for interior designers and facility planners to enhance workplace performance. This modern suite of applications works together seamlessly, in concert. Navigate catalogs, select products, design in plan view and 3D, assign options, create worksheets and build a project where you want, when you want. Take your pick. It's dynamic and interactive. Design projects are a work in progress. And now you can perform any of the many discrete tasks that go into a project any time, any place.

For additional information, you may contact 2020 Cap direct at 800-227-0038.

Product symbols (Revit, 2D and 3D) are available on the Nucraft website at www.nucraft.com/resources/product-symbols.

iSpec®

Nucraft offers a free online product configuration and specification service that saves you time and allows you to be creative while leaving the nuts and bolts to someone else. No specific software is required, nor is there any learning curve. This service applies to all Nucraft products. For additional information, call 1-877-NUCRAFT and ask for the iSpec Team or log on to www.nucraft.com/resources/ispec.



FINISH INFORMATION

Surface Materials Palette

We crafted our materials palette using the same demanding standards that distinguish our furniture. Thoughtful design and attention to every detail elevate your possibilities.

Anchored by Nucraft veneers, unrivaled for clarity, quality, and depth of finish, our collection of surface materials comprises a sophisticated set of balanced elements that supports your design vision.

Some elements have their roots in Nucraft's rich heritage. Others are new materials and reflect current trends and taste. Together, they ensure that you're ready for today and positioned well for the future. Beautifully.

Custom Finishes

Nucraft specializes in expert custom finish matching. For a nominal upcharge we can provide custom finishes, and we are frequently asked to match the finishes of other furniture manufacturers. For finishes that appear unusual to match or for customers directly requesting a sample, a finish sample will be sent for approval prior to entering the order.

Custom finishes requiring colored varnishes to create a painted look can only be applied to Maple veneer and require one extra week in addition to the standard lead time. Nucraft's standard black finish (G82) can be applied to all Nucraft standard veneers. Walnut is the standard black veneer. Other species must be specified when ordering.

Clear coat on a special veneer requires an approved sample.

Custom finishes carry a 10% upcharge per item, per finish, capped at \$2,100 List.

Custom finish upcharges are not applied to any item that is not wood. Example: casters, ganging connectors, power options..

Treatments

Note: Default veneer sheen will vary per finish and product. Default finish is bolded on pages vi-vii. If no direction is provided on incoming orders, default sheen will be selected. In addition, default veneer cut is noted in the price list. If no direction is provided on incoming orders, default cut will be selected.

Gloss: Gloss is a durable finish that tends to nicely mask normal wear and leaves wood grain visible to the eye. It achieves a medium gloss open pore appearance (40 – 50 sheen range). Finish numbers preceded by the letter "G" indicate a Gloss finish.

Matte: Like Gloss, Matte is durable, tends to nicely mask normal wear and leaves wood grain visible to the eye. It achieves a low luster, open pore appearance (10 – 20 sheen range). Finish numbers preceded by the letter "M" indicate a Matte finish.

Since each veneer type responds differently to both types of treatment, all will have a distinctive look and feel when finished. For example, a Walnut veneer with a Gloss treatment will remain much more textured than a Cherry veneer with the same treatment.

About the Wood

All Nucraft veneers are carefully selected for uniformity of color and grain. Still, wood is a natural substance and minor variations may occur due to its own uniqueness. Because of this, the furniture you receive may not be an exact match to our samples.

Nucraft takes great pride in our finish color consistency. However, wood is a natural product that will have color variation within a single piece of furniture, as well as from one piece to the next. Other factors also affect color over time, such as exposure to light (both intensity and duration). For example, lighter finishes cause more variation in colors over time.

In cases where a returning customer wants a precise match with existing furniture, we recommend sending a sample of the existing furniture finish. Please contact Nucraft Customer Service to determine an appropriate sample. This will ensure a finish match between old and new orders. This type of order is considered a control sample. There will be a 10% upcharge on an order of this type. Due to natural aging of veneers, natural finishes may vary.

Care and Maintenance of Wood Finishes

Our finish material is a crystal clear, urethane acrylic blend. This type of finish may be repaired in the field by a qualified refinisher.

Nucraft recommends using a damp cloth to clean your fine wood furniture. Always wipe with the grain of the wood. Should your wood furniture require a more thorough cleaning, we recommend using a mild cleaner such as Joy dish soap or Murphy's oil soap, thoroughly diluted in water (one part soap to thirty parts water). Water will not damage Nucraft's finish, but it may leave surface spots when it dries. To avoid this, dry the surface with a soft cloth after it is cleaned. Marks that cannot be removed with the cleaning methods above may be able to be removed using naphtha, a mild degreasing solvent.

Caution: while the use of polishes that contain wax, petroleum solvents or silicones may immediately enhance the "shine" of a product, it may also eventually remove the fine original finish applied in our factory. Silicone on the surface of wood may also make it very difficult to respray or refinish.

All Nucraft furniture is inspected and polished before it leaves our factory. In some instances, the packing materials may imprint on the factory polish. Cleaning and polishing the furniture once it is unpacked will normally restore the furniture to its original beauty.

In some cases, the rubber support feet used on the bottom of common office equipment (teleconferencing phones, laptops, microphones, copiers, etc.) can create unsightly marks in the surface of wood tops, due to oxidation of the lacquer finish. We suggest these machines be placed on a protective type of padding, such as felt.

Wood will fade as a result of exposure to UV light. This is particularly prevalent with light finishes. If color changes due to fading are a concern for your application, the impact can be minimized by selecting medium to dark stains for your wood surfaces. Our top coat includes a UV inhibitor which makes the finishes less prone to fading.



FINISH INFORMATION

Laminates

Selected Formica®, Nevamar®, and Wilsonart® laminates are available on Training Tables, Conference Tables, Conference Room Furniture and select Occasional Tables. For standard laminate and wood pricing, refer to individual item pricing columns.

Non-Standard Laminates and Linoleums

To order a color other than those on our list (see pages vi-vii), refer to Nevamar or Formica standard grade, matte texture laminate offerings and Forbo Furniture Linoleums (excluding manufacturers' non-standard matte offering).

Nucraft can support other laminate and linoleum options beyond what can be found as standard options on pages vi-viii. For pricing, please send a request to quotes@nucraft.com.

Care and Maintenance of Laminate and Novawrap

Laminate and Novawrap surfaces may be cleaned with a damp cloth and ordinary soap or non-abrasive household liquid detergent. Dry the surface with a clean cloth or soft paper towel to prevent streaks from appearing.

Care and Maintenance of Metal

Metal surfaces can be wiped with a damp cloth and rubbed dry. A mild non-abrasive household liquid detergent can be used if necessary. Regular maintenance of metal components, including tightening of fasteners and light lubrication of moving parts, will extend the life of your furniture.

Satin Etched Glass

Glass color may vary slightly on multi-piece conference table tops over 180" x 60" when satin etched glass is specified due to the iron content and etching process of the glass.

Care and Maintenance of Glass

Clear or frosted glass may be cleaned with commercial glass cleaner. Be sure to use a lint-free cloth if cleaning the frosted side of the glass.

Stone and Solid Surface Material

Despite its reputation for durability, natural stone can easily be broken during handling and/or installation if proper techniques are not followed. In addition, Nucraft is not responsible for the installation of natural stone or solid surface materials on its products. Therefore, installers specifically trained in the installation of these materials must be utilized to ensure a quality installation. Nucraft shall not be liable for any damages incurred during the handling and/or installation of natural stone or solid surface materials on its products.

Care and Maintenance of Granite

Granite surfaces may be cleaned with a damp cloth and ordinary soap or non-abrasive household liquid detergent. Dry the surface with a clean cloth or soft paper towel to prevent streaks from appearing.

Care and Maintenance of Leather

Genuine leather requires very little care. Nucraft recommends that leather be dusted regularly. If a more thorough cleaning is needed, use lukewarm water and a mild, non-abrasive soap. Generate some lather and lightly rub the surface with cheesecloth. Rinse off any soap film with clean water and towel dry. The leather may dry dull. To restore the leather to a normal gloss, rub it with a clean towel. Never use furniture polish, oil, varnish or ammonia. Saddle soap may be used to prevent the leather from becoming brittle or cracked and to maintain the original supple finish.

Touch Up Finish Kits

Model #	Description	Price
KIT-M	Metal Kit	85
KIT-P	Paint Kit	85
KIT-S	Stain Kit	85

REQUIRED INFORMATION: (ORDER CANNOT BE ENTERED WITHOUT THIS INFORMATION)

- Kit model number
- Quantity of kits
- Specify finish (See pages vi-vii)

General Information:

- Touch-up kits must be ordered on a purchase order separate from Nucraft product due to Hazmat shipping

Retrofit & Replacements

If needing a partial placement or retrofit solution, please reach out to our quote team. Grain/color matched in a set.



CROSSBEAM SURFACE MATERIALS

WOOD FINISHES

STANDARD

Default veneer sheen will vary per finish and were determined by a team of experts who reviewed the colorways to determine if gloss or matte best highlighted the natural characteristics of the species of wood and the color of the stain. Default finish is bolded. If no direction is provided, default sheen will be selected.

	Matte	Gloss
Rift Cut Oak		
Carbon	M03	G03
Flat Cut Oak		
Dune	M05	G05
Portobello	M7413	G7413
Flaky Oak		
Sahara	M61	G61
Cherry		
Cognac	M21	G21
Auburn	M93	G93
Walnut		
Marron	M35	G35
Mocha	M33	G33
Zinc	M30	G30
Onyx	M82	G82
Otter	M31	G31
Maple		
Natural Maple	M60	G60
Linea		
Oak Linea	M08	G08
Walnut Linea	M27	G27
Euro Birch Linea	M09	G09
Silver Birch Linea	M10	G10
Paldao		
Thicket	M75	G75
Paldao	M76	G76
Canyon	M77	G77

METAL FINISHES

Powder Coat

Aged Bronze	A8010
Black	A44
Burnished	A8009
Cloud	A8004
Foil	A8006
Galaxy	A8007
Moonlight	A87
Satin Bronze	A8011
Shadow	A8005
Storm	A8012

Metal

Polished Chrome*	PC
------------------	----

*Up-Charge applies.

PAINTS

Aged Bronze	S8010
Black	S44
Burnished	S88
Cloud	S8004
Foil	S8006
Galaxy	S8007
Moonlight	S87
Satin Bronze	S8011
Shadow	S8005
Storm	S8012

Paint to Match

To request a custom paint color, contact Nucraft Customer Service. A paint sample must be matched and approved prior to order.

SOLID SURFACE TOPS

Wilsonart Designer White	ST11
--------------------------	------

LEATHER

Spinneybeck | Vicenza

Ponte Furo	VZ 2102
Salvi	VZ 2011
Villabalzana	VZ 2108
Castello di Bellaguardia	VZ 2112
Scamozzi	VZ 2114
Peralolo	VZ 2115
Costozza	VZ 2116
Nocciola	VZ 2117
Appia Antica	VZ 2120
Cinque Terre	VZ 2122
Black	VZ BLCK



CROSSBEAM SURFACE MATERIALS

STONE TOPS

Stone orders may affect lead times. Please contact NuCraft Customer Service for details.

Stone		Subtop Paint Color
Absolute Black Honed Granite	ST01	S8007
Carrara Marble	ST16	S8004

Quartz | Cambria® Signature

Ainsley	STC100	S8004
Armitage	STC101	S44
Avalene	STC192	S8004
Bellingham	STC102	S8004
Berkeley	STC103	S8004
Berwyn	STC104	S8004
Blackbrook	STC105	S44
Bradshaw	STC106	S8004
Bradwell	STC107	S8004
Cambria Black	STC109	S44
Carrick	STC110	S44
Clifton	STC112	S8004
Colton	STC113	S8004
Copeland	STC200	S8004
Crowndale	STC114	S8004
Devon	STC115	S44
Fairbourne	STC116	S8004
Fieldstone	STC117	S44
Hadley	STC201	S8004
Halewood	STC119	S8004
Hermitage	STC120	S8004
Kendal	STC122	S8004
Laneshaw	STC124	S44
MacBeth	STC202	S8004
Malvern	STC125	S8004
Montgomery	STC128	S8004
New Quay	STC130	S8004
Pendle Hill	STC131	S8004
Praa Sands	STC132	S8004
Ridgegate	STC203	S8004
Rose Bay	STC133	S8004
Sandgate	STC135	S8004
Seacourt	STC204	S8004
Smithfield	STC136	S8004
Sutherland	STC138	S8004
Swanbridge	STC139	S8004
Torquay	STC140	S8004
Trafalgar	STC205	S8004
Travella	STC141	S8004
Weybourne	STC143	S8004
Whitendale	STC206	S8004
Whitney	STC144	S8004
Woodcroft	STC146	S44

Quartz | Cambria® Luxury

Abbey	STC147	S8004
Annaleigh - Luxe	STC193	S8004
Annicca	STC148	S8004
Beckington	STC150	S8004
Bentley	STC151	S8004
Blackpool Matte	STC152	S44
Brighton	STC212	S8004
Brittanicca	STC153	S8004
Brittanicca Gold Cool	STC154	S8004
Brittanicca Gold Warm	STC155	S8004
Brittanicca Warm	STC156	S8004
Clovelly	STC158	S8004
Delamere	STC159	S44
Delgatie	STC160	S8004
Ella	STC161	S8004
Everleigh	STC162	S8004
Everleigh Warm	STC191	S8004
Gladstone	STC163	S8004
Golden Dragon	STC164	S44
Hailey	STC165	S8004
Harlow	STC166	S8004
Hemsworth	STC167	S8004
Huntley	STC168	S8004
Inverness Blakeley	STC190	S8004
Inverness Bristol Bay	STC169	S8004
Inverness Bronze	STC170	S8004
Inverness Cobalt	STC171	S8004
Inverness Everleigh	STC172	S8004
Inverness Frost	STC196	S8004
Inverness Gold	STC197	S8004
Inverness Platinum	STC173	S8004
Inverness Swansea	STC174	S8004
Ironsbridge	STC175	S8004
Iverness Frost	STC176	S8004
Iverness Gold	STC177	S8004
Lakedale	STC179	S8004
Mayfair	STC181	S8004
Mersey	STC182	S44
MonTajaj - Luxe & Satin	STC199	S8004
Notting Hill	STC183	S8004
Oakleigh	STC184	S8004
Portrush	STC185	S8004
Queen Anne	STC186	S8006
Remington Brass Satin	STC210	S44
Remington Steel Satin	STC211	S44
Skara Brae	STC187	S8004
Southport	STC188	S8004
White Cliff	STC189	S8004

Quartz | Wilsonart

Carrara Codena	ST21	S8004
Serene	ST17	S8004



CROSSBEAM SURFACE MATERIALS

GLASS (SATIN OR GLOSS)

	Satin	Gloss
Black	BS	-
Clove	VS	VG
Meringue	MS	MG
Quill	QS	QG
Moonlight	MLS	MLG
Storm	STS	STG
White	WS	WG

Note: Due to color variation inherent in the natural acid etching process, Satin Etched Glass is not available on tables longer than 180" or wider than 60"

ACRYLIC

Crossbeam Center Base Panels only. Upcharge applies.

Bronze Mirrored	MABP
-----------------	------

CHEMETAL

Crossbeam Center Base Panels only. Upcharge applies.

Brushed Aluminum	902
Light Stainless Aluminum	927
Brushed Golden Aluminum	931
Polished Aluminum	901

LAMINATES

Wood Grain Laminates [§]	Code	Coordinating Wood Finish	Coordinating Woodgrain Edgeband
Formica White Ash	8841-58	M8841	R8841
Formica Natural Ash	8843-58	M8843	R8843
Formica Aged Ash	8844-58	M8844	R8844
Formica Weathered Ash	8842-58	M8842	R8842
Formica Oiled Legno	8846-58	M8846	R8846
Formica Bleached Legno	8845-58	M8845	R8845
Formica Blackened Legno	8848-58	M8848	R8848
Formica Urban Planked Oak	9312-58	M9312	R9312
Formica Thermo Walnut	6402-58	M6402	R6402
Formica Smoky Brown Pear	5488-58	M5488	R5488
Formica Espresso Pear	5489-58	M5489	R5489
Formica Sand Maple	9237-58	G60	W7909
Formica Planked Coffee Oak	7413-58	M7413	F7413

[§]Not available on multiple piece conference tables

Wood Grain Laminates Suitable for Multiple Piece Conference Tables

Formica Pecan Woodline	5883-58	M5883	R5884
Formica Chestnut Woodline	5884-58	M5884	R5885

Solid Laminates

Formica Brite White	459-58	R01
Formica Dover White	7197-58	R01
Formica Pearl	934-58	R02
Formica Graystone	464-58	R02
Formica Folkstone	927-58	R03
Formica Graphite	837-58	R05

Patterned Laminates

Nevamar Cool Chic	VA7002T	R02
Nevamar Serene Stardom	VA5001T	R05
Nevamar Calm Distinction	VA6001T	R05
Nevamar Easy Elegance	VA5002T	R05
Wilsonart Sheer Mesh	4876-38	R02
Wilsonart Grey Mesh	4877-38	R02
Wilsonart Pewter Mesh	4878-38	R05

ABS FINISHES

Ashen	R04
Parchment	R02
Shale	R05
Stone	R03
Whitecap	R01